

City of Flint, Michigan

*Third Floor, City Hall
1101 S. Saginaw Street
Flint, Michigan 48502
www.cityofflint.com*



Meeting Agenda - Final

Monday, July 22, 2024

5:30 PM

Council Chambers

CITY COUNCIL

Ladel Lewis, President, Ward 2

Candice Mushatt, Vice President, Ward 7

*Leon El-Alamin, Ward 1
Judy Priestley, Ward 4
Tonya Burns, Ward 6*

*Quincy Murphy, Ward 3
Jerri Winfrey-Carter, Ward 5
Dennis Pfeiffer, Ward 8*

Jonathan Jarrett, Ward 9

Davina Donahue, City Clerk

CALL TO ORDER**ROLL CALL****PLEDGE OF ALLEGIANCE****PRAYER OR BLESSING****READING OF DISORDERLY PERSON CITY CODE SUBSECTION**

Any person that persists in disrupting this meeting will be in violation of Flint City Code Section 31-10, Disorderly Conduct, Assault and Battery, and Disorderly Persons, and will be subject to arrest for a misdemeanor. Any person who prevents the peaceful and orderly conduct of any meeting will be given one warning. If they persist in disrupting the meeting, that individual will be subject to arrest. Violators shall be removed from meetings.

REQUEST FOR AGENDA CHANGES/ADDITIONS**PUBLIC HEARINGS****240232.6** Public Hearing/Vacation of Dewey Street

A Public Hearing to consider the vacation of Dewey Street, between North Saginaw Street and North Street, to hear from all interested parties.

240261.6 Public Hearing/Ordinance No. 240261

A Public Hearing for Ordinance No, 240261, an ordinance to amend the Flint City Code of Ordinances by amending Chapter 50 (Zoning), Article XXX (Flood Hazard Management), by amending Section 50-172 (Flood Insurance Study Adopted).

240264.6 Public Hearing/Ordinance No. 240264

A Public Hearing for Ordinance No. 240264, an ordinance to amend the Code of the City of Flint by amending Chapter 50 (Zoning), Article 18 (Administration and Enforcement), by amending Section 50-200 (Authority of the Zoning Coordinator) and Section 50-202 (Enforcement Powers).

PUBLIC COMMENT

Members of the public who wish to address the City Council or its committees must register before the meeting begins. A box will be placed at the entrance to the Council Chambers for collection of registrations. No additional speakers or slips will be accepted after the meeting begins.

Members of the public shall have no more than three (3) minutes per speaker during public comment, with only one speaking opportunity per speaker.

COUNCIL RESPONSE

Councilmembers may respond once to all public speakers only after all public speakers have spoken. An individual Councilmember's response shall be limited to two (2) minutes.

RECONSIDERATION(S)

[NOTE: Resolution No. 230144 (a Resolution Authorizing Entry Into Administrative Consent Order Between the City of Flint and the State of Michigan, Department of Environment, Great Lakes and Energy, Drinking Water and Environmental Health Division) FAILED 4:3 (No: Winfrey-Carter, Burns, Jarrett) (Absent: Murphy, Pfeiffer) during the July 17, 2024 Special City Council Meeting. Resolution No. 230227 (a Resolution Approving Reallocation of ARPA Funds to Proceed with Grants for Youth Job Training for Faith Foundation Resources) FAILED 4:2:1 (No: Burns, Jarrett) (Abstention: Winfrey-Carter) (Absent: Murphy, Pfeiffer) during the July 17, 2024 Special City Council Meeting. They are presented here for Council's (re)consideration.]

240144 Administrative Consent Order/City of Flint/State of Michigan/Department of Environment, Great Lakes and Energy [EGLE]/Drinking Water and Environmental Health Division

Resolution resolving that the City Council approves authorizing the City of Flint to take all actions necessary to enter into DWEHD Order No. ACO-399-03-2024 ("Administrative Consent Order between the City of Flint and EGLE"). [NOTE: The State of Michigan, Department of Environment, Great Lakes, and Energy ("EGLE"), Drinking Water and Environmental Health Division ("DWEHD") has made allegations that the City of Flint is in violation of the Michigan Safe Drinking Water Act, 1976 PA 399, as amended (Act 399), and the administrative rules promulgated thereunder, being 2009 ACS R 325.10101, et seq., Title XIV of the Public Health Service Act: Safety of Public Water Systems (Safe Drinking Water Act), Title 42 of the United States Code (USC), Section 300f, et seq. (collectively, the "SDWA"). The City of Flint and EGLE have tentatively agreed to resolve the violations alleged by EGLE through entry of an Administrative Consent Order.]

240227 Reallocation of ARPA Funds/Grants for Youth Job Training/Faith foundation Resources

Resolution resolving that the appropriate City Officials are authorized to do all things necessary, including executing any necessary agreements, to appropriate funding from the funding source account #101-287.000-963.000 to Faith Foundation Resources, in the amount of \$200,000. Based on review and validation of the appropriate fund use by the City's compliance firm, implementation of these funds will be consistent and compliant with US Department of Treasury requirements and previously approved authorizations.

CONSENT AGENDA

Per the amended Rules Governing Meetings of the Flint City Council (as adopted by the City Council on Monday, April 22, 2024), the Chair may request the adoption of a "Consent Agenda". After a motion to adopt a Consent Agenda is made and seconded, the Chair shall ask for separations. Any agenda item on a Consent Agenda shall be separated at the request of any Councilmember. After any separations, there is no debate on approving the Consent Agenda - it shall be voted on or adopted without objection.

PRESENTATION OF MINUTES

PETITIONS AND COMMUNICATIONS

240307 Entire Tribunal Case Information Sheet and Property Tax Petition/Proof of Service of Petition/Michigan Tax Tribunal/3901 N. Averill Ave, LLC v City of Flint/MTT Docket No: 23-002086

Communication received July 17, 2024, re: Proof of Service and Petition filed with the Michigan Tax Tribunal by 3901 N. Averill Ave, LLC regarding Parcel No. 47-33-376-120.

APPOINTMENTS

240275 Appointment of Dominique Strong/Flint Housing Commission

Resolving that the Flint City Council approves the appointment of Dominique Strong, of Sherry Drive, Flint, MI 48506, to the Flint Housing Commission for a 5-year term beginning on September 1, 2024 and expiring on August 31, 2029.

240276 [Re]Appointment Sheryl D. Thompson/Board of Directors/Valley Area Agency on Aging

Resolving that, the Flint City Council approves the appointment of Sheryl D. Thompson, of Crestbrook Lane, Flint, MI 48507, to the Valley Agency on Aging Board.

240277 Reappointment of Trachelle Young/Ethics and Accountability Board

Resolving that the Flint City Council approves the reappointment of Trachelle Young, of Crescent Dr, Flint, MI 48503, to the Ethics and Accountability Board, to fill a six-year term ending on June 26, 2030.

240296 Reappointment/Zoning Board of Appeals/Willie Buford

Resolution resolving that the Flint City Council approves the reappointment of Willie Buford (3206 Keyes Street, Flint, Michigan, 48504 - Ward 2) to the Zoning Board of Appeals for a 3-year term commencing September 1, 2024 upon adoption of this resolution and expiring August 31, 2027.

240297 Reappointment/Zoning Board of Appeals/Derek Dohrman

Resolution resolving that the Flint City Council approves the reappointment of Derek Dohrman (307 Mason Street, Flint, Michigan, 48503 - Ward 5) to the Zoning Board of Appeals for a 3-year term commencing immediately upon adoption of this resolution and expiring August 31, 2026.

240298 Appointment/Human Relations Commission/Bre'anne Morris

Resolution resolving that the Flint City Council approves the appointment of Bre'anne Morris to the Human Relations Commission for a 3-year term commencing immediately upon adoption of this resolution and expiring October 28, 2026.

240305 Appointment/Ethics and Accountability Board/Brian Larkin

Resolution resolving that the Flint City Council approves the reappointment [appointment] of Brian Larkin (Circle Dr, Flint, MI 48507) to the Ethics and Accountability Board, to fill the remainder of a six-year term ending on June 26, 2026.

240306 Reappointment/Ethics and Accountability Board/Linda K. Boose

Resolution resolving that the Flint City Council approves the reappointment of Linda Boose (2803 Wilton Place, Flint, MI 48506) to the Ethics and Accountability Board, for a six-year term commencing immediately and ending on June 25, 2030.

RESOLUTIONS

240240 Reallocation of ARPA Funds/Mental Health Referrals and Services Support/Flint Institute of Music

Resolution resolving that the appropriate City officials are authorized to do all things necessary, including executing any necessary agreements, to appropriate funding from the funding source account #101-287.000-963.000 to Flint Institute of Music in the amount of \$189,000. Based on review and validation of the appropriate fund use by the City's compliance firm, implementation of these funds will be consistent and compliant with US Department of Treasury requirements and previously approved authorizations.

240241 Reallocation ARPA Funds/ Utilization/Pandemic Impact on Housing for Flint Homeowners/Contract/Habitat/Homeowner Education Assistance

Resolution resolving that the appropriate City Officials are authorized to do all things necessary, including executing any necessary agreements, to appropriate funding from the funding source account #101-287.000-963.000 to Genesee County Habitat for Humanity (GCHFH) in the amount of \$50,000. Based on review and validation of the appropriate fund use by the City's compliance firm, implementation of these funds will be consistent and compliant with US Department of Treasury requirements and previously approved authorizations.

- 240272** Tentative Agreement/City of Flint and AFSCME Council 925 - Local 1799/Memorandum of Understanding (MOU)
- Resolution resolving that the Flint City Council RATIFIES the Tentative Agreement between the City of Flint and AFSCME Local 1799, and authorizes the Director, Human Resources & Labor Relation, to execute a Memorandum of Understanding so providing.
- 240278** Donation/Fireman's Challenge Tournament
- Resolution resolving that the appropriate City Officials are authorized to do all things necessary to accept the Fireman's Challenge donation check and cash received from PI KAPPA ALPHA FRATERNITY, ZETA ALPHA B CHAPTER at Kettering University, amend the FY25 budget, appropriate funding for revenue and expenditures for the FY25 budget year in the amount of \$3,269.00 and to record the donation revenue with grant code OPKA-FRCHDN.
- 240279** Grant Acceptance/Continuing Professional Education (CPE)/Michigan Commission on Law Enforcement Standards/Flint Police Department
- Resolution resolving that the appropriate City officials are hereby authorized to do all things necessary to accept the funds enacted by Michigan Legislature PA1, amend the FY24 and FY25 budgets, appropriate award funding for revenue and expenditures in future fiscal years as long as the funds are available from the funder, and abide by the terms and conditions of the award from the State of Michigan, in the amount of \$49,500, to grant code SMLES-CPE24.
- 240280** CO#4/Contract/Sorensen Gross/Dort Pump Station Rehabilitation
- Resolution resolving that the proper City Officials are hereby authorized to enter into Change Order No. 4 to the contract with Sorensen Gross for the Dort Pump Station Rehabilitation Project, in an amount NOT-TO-EXCEED \$51,880.50 for FY25 (07/01/2024-06/30/2025) for an aggregate grand total amount not to exceed \$4,451,271.97.
- 240282** Deere Credit, Inc./Equipment Leases
- Resolution resolving that the Division of Purchases & Supplies is hereby authorized to issue a Purchase Order to Deere Credit, Inc. for Fleet leased heavy equipment during FY25 (07/01/24-06/30/25) in an amount NOT-TO-EXCEED \$76,759.25 [Backhoe @ Water Pollution Control; Front-End Loader @ Street Maintenance].
[Enter body here.]
- 240283** Police Management System/Tyler Technologies/New World Systems
- Resolution resolving that the proper City Officials, upon the City Council approval, are hereby authorized to enter into an agreement for standard software maintenance with Tyler Technologies New World System for the

period July 1, 2024 through June 30, 2025, NOT-TO-EXCEED \$82,710.55.

240284

Reallocation of ARPA Funds/OPIOID Funds/Grants for Emergency Water Relief Funds

Resolution resolving that the appropriate City officials are authorized to transfer \$50,000 from ARPA Revenue Replacement (General Fund 101 account 101-000.000-385.287) and \$50,000 from the Opioid Fund Balance (Opioid Fund 288 account #288-266.210-963.000) to Water/Sewer Emergency Relief for emergency water/sewer payment assistance.

240285

Contract/Genesee Conservation District/Tree Inspections/Sidewalk Impact

Resolution resolving that the appropriate City Officials are authorized to do all things necessary, including executing any necessary agreements, to appropriate funding from the funding source account 101-287.000-963.000 to Genesee Conservation District (Genesee Soil & Water Conservation) for the cost of providing professional services needed to evaluate trees that are impacting sidewalks in the City of Flint in an amount NOT-TO-EXCEED \$200,000.00. Based on review and validation of the appropriate fund use by the City's compliance firm, implementation of these funds will be consistent and compliant with the US Department of Treasury requirements and previously approved authorizations.

240286

Lease Servicing Center, Inc. dba National Cooperative Leasing/Equipment Leases

Resolution resolving that the Division of Purchases and Supplies is hereby authorized to issue a Purchase Order to Lease Servicing Center, Inc. dba NCL (National Cooperative Leasing) to provide seven (7) leased 2019 International plow trucks for FY25 (07/01/24-06/30/25) in an amount NOT-TO-EXCEED \$272,943.79.

240287

CO#1/Contract/DHT Transportation/Sewage Sludge Transportation Services

Resolution resolving that the proper City Officials are hereby authorized to enter into Change Order No. 1 with DHT Transportation for additional sludge hauling and transportation services NOT-TO-EXCEED \$40,000.00 for FY24 (07/01/2023-06/30/24) for an FY24 Grand Total amount NOT-TO-EXCEED \$290,000.000.

240288

Curbco Sweeping, Inc./Street Sweeping Services

Resolution resolving that the proper City Officials are hereby authorized to enter into a contract with Curbco Sweeping, Inc. for street sweeping services, in the amount NOT-TO-EXCEED \$299,700.00.

240289

Contract/Complete Auto & Truck Parts/Towing and Storage of Vehicles/Flint Police Department

Resolution resolving that the proper City Officials, upon City Council's approval,

are hereby authorized to enter into a contract with Complete Auto & Truck Parts, Inc. for the City of Flint Police Department for the towing and storage services, for a total NOT-TO-EXCEED \$430,000.00 for FY2025 (07/01/2024-06/30/2025).

240290 Budget Amendment/City of Flint/Accept Grant US Environmental Protection Agency

Resolution resolving that the appropriate City officials are authorized to do all things necessary to abide by the terms of the Environmental Justice Government - to - Government (EJG2G) grant #OOE03636 in the amount of \$1,000,000.00 for three (3) years total, to appropriate revenue and expenditure amounts using grant code FEPA-EVG2G24, and to make the grant funds available in the current and any subsequent fiscal years that funding continues to remain available by the grantor.

240291 Contract/LA Construction/Avon Pump Station Demolition

Resolution resolving that the Proper City Officials are hereby authorized to enter into a contract with L.A. Construction Corporation for the Avon Pump Station Demolition project for FY25 (07/01/24-06/30/25) in the amount NOT-TO-EXCEED \$2,172,578.42 (which includes a 6% contingency of \$122,976.12), contingent upon successful financial arrangements with the SRF Program.

240292 J. RANCK Electric, Inc./Electrical Distribution Improvements-Transformers (CSWRF PHASE VI)

Resolution resolving that the Proper City Officials are hereby authorized to enter into a contract with J. Ranck Electric Inc. for Electrical Distribution Improvements-Transformers Project for FY25 (07/01/24-06/30/25) in an amount NOT-TO-EXCEED \$4,718,269.00 (which includes a 6% contingency of \$267,044.00), contingent upon successful financial arrangements with the SRF Program.

240293 Ric-Man Construction/Third (3rd) Avenue Pump Station Force Main Rehabilitation Project (CSWRF PHASE VI)

Resolution resolving that the proper City Officials are hereby authorized to enter into a contract with Ric-Man Construction, Inc. for the Third (3rd) Avenue Force Main Rehabilitation Project for FY25 (07/01/24-06/30/25) in an amount NOT-TO-EXCEED \$54,994.484 [\$54,994,484.00] (which includes a 6% contingency), contingent upon successful financial arrangements with the SRF Program.

240295 Approving Reallocation of ARPA Funds Proceed with Grants/Blight Remediation/Neighborhood Engagement Hub/2nd Ward for 2025

Resolution resolving that the appropriate City officials are authorized to do all things necessary, including executing any necessary agreements, to appropriate funding from the funding source account #101-287.000-963.000 to

the Neighborhood Engagement Hub in the amount of \$10,000.00

240302

Reallocation of ARPA Funds/Grants/Youth Job Training/Active Boys In Christ

Resolution resolving that the appropriate City officials are authorized to do all things necessary, including executing any necessary agreements, to appropriate funding from the funding source account #101-000.000-385.287 to Active Boys in Christ in the amount of \$146,750. Based on review and validation of the appropriate fund use by the City's compliance firm, implementation of these funds will be consistent and compliant with US Department of Treasury requirements and previously approved authorizations.

240303

INA Store, Inc./Case Wheel Loader/Street Maintenance Division

Resolution resolving that the appropriate City Officials are authorized to amend the FY2025 by transfer of funds for \$217,641.59 from Fleet (661) fund balance. Further resolving that the Purchasing Division is now authorized to issue a purchase order INA SStore, Inc. to purchase a Case brand wheel loader in an amount not to exceed \$217,641.59.

240304

Utilize Opioid Settlement Funding and ARPA Funding/Purchase of (2) Ambulance/EMT Units/City of Flint Fire Department

Resolution resolving that the Flint City Council appropriates Opioid Settlement funds in an amount not to exceed \$200,000.00 to purchase (2) ambulances and needed supplies and equipment for operations of the ambulances services. Further resolving that the appropriate City Officials are authorized to appropriate \$200,000.00 in Fund Balance Assigned ARPA monies to the cost of the (2) ambulances and needed supplies and equipment for operations of the ambulance services. Procurement will follow compliance and procedures in accordance with Treasury Final Rules.

RESOLUTIONS (May Be Referred from Special Affairs)

240232.1

Street Vacation/Dewey Street (Between N. Saginaw and North Streets)

Resolution resolving that Dewey Street between North Saginaw Street and North Street is hereby vacated and discontinued forever as a public street, alley, or public ground, and the same is hereby placed on the assessments rolls for the purpose of taxation., AND, further resolving that the City Clerk shall, within thirty (30) days of this action, record a certified copy of this resolution with the Register of Deeds for Genesee County and forward a certified copy to said resolution to the State Treasurer.

240294

Reallocation of ARPA Funds/Grants for Neighborhood Engagement and Youth Programs/7th Ward-Ward Account

Resolution resolving that the appropriate City Officials are authorized to do all things necessary, including executing any necessary agreements, to appropriate funding from the funding source account #101-287.000-963.000, to the Neighborhood Engagement Hub, in the amount of \$16,000.00 (Southside

Neighborhood Coalition, Evergreen Block Watchers, College Cultural Neighborhood Association), and to Court Street Village Non-profits, in the amount of \$14,000.00 (Central Park Neighborhood Association, Fairfield Village Neighborhood Coalition), for a total amount of \$30,000 (Ward Account - 7th Ward). Based on review and validation of the appropriate fund use by the City's compliance firm, implementation of these funds will be consistent and compliant with US Department of Treasury requirements and previously approved authorizations.

RESOLUTIONS (May Be Reconsidered)

- 240144** Administrative Consent Order/City of Flint/State of Michigan/Department of Environment, Great Lakes and Energy [EGLE]/Drinking Water and Environmental Health Division

Resolution resolving that the City Council approves authorizing the City of Flint to take all actions necessary to enter into DWEHD Order No. ACO-399-03-2024 ("Administrative Consent Order between the City of Flint and EGLE"). [NOTE: The State of Michigan, Department of Environment, Great Lakes, and Energy ("EGLE"), Drinking Water and Environmental Health Division ("DWEHD") has made allegations that the City of Flint is in violation of the Michigan Safe Drinking Water Act, 1976 PA 399, as amended (Act 399), and the administrative rules promulgated thereunder, being 2009 ACS R 325.10101, et seq., Title XIV of the Public Health Service Act: Safety of Public Water Systems (Safe Drinking Water Act), Title 42 of the United States Code (USC), Section 300f, et seq. (collectively, the "SDWA"). The City of Flint and EGLE have tentatively agreed to resolve the violations alleged by EGLE through entry of an Administrative Consent Order.]

- 240227** Reallocation of ARPA Funds/Grants for Youth Job Training/Faith foundation Resources

Resolution resolving that the appropriate City Officials are authorized to do all things necessary, including executing any necessary agreements, to appropriate funding from the funding source account #101-287.000-963.000 to Faith Foundation Resources, in the amount of \$200,000. Based on review and validation of the appropriate fund use by the City's compliance firm, implementation of these funds will be consistent and compliant with US Department of Treasury requirements and previously approved authorizations.

LICENSES

- 240273** Marihuana Retail/Group E Marihuana Retail - Adult Use License/CFMJ, LLC

Resolution resolving that, Pursuant to [Flint City Code Section] 50-80.6(A0(2)), the appropriate City officials are hereby authorized to do all things necessary to issue a license to applicant Bruce Leach of CFMJ, LLC, located at 2926 Robert T. Longwat Blvd., Flint.

- 240274** Group G Regulated Use/Class A Microbusiness/Crooked Ladder, Inc./2730 S.

Dort Hwy.

Resolution resolving that, Pursuant to [Flint City Code Section] 50-80.6(A0(2), the appropriate City officials are hereby authorized to do all things necessary to issue a license to applicant John McNicol of Green Buddha, LLC, located at 2730 S. Dort Hwy.

SECOND READING AND ENACTMENT OF ORDINANCES

[NOTE: Public Hearings for Ordinances No. 240191 and 240192 were held on Monday, June 10, 2024.]

- 240191** Amendment/Ordinance/Chapter 31 (General Offenses)/Article I (In General)/Section 31-10 (Disorderly Conduct, Assault and Battery, And Disorderly Persons)
- An ordinance to amend Chapter 31 (General Offenses), Article I (In General), of the Code of the City of Flint by amending Section 31-10 (Disorderly Conduct, Assault and Battery, And Disorderly Persons). [NOTE: This ordinance shall become effective 30 days after enactment.]
- 240192** Amendment/Ordinance/Chapter 46 (Utilities)/Article II (Water Supply and Sewage Disposal System)/Division 5 (Replacement Lead Service Lines)
- An ordinance to amend Chapter 46 (Utilities), Article II (Water Supply and Sewage Disposal System), by the addition of Division 5 (Replacement of Lead Service Lines). [NOTE: This ordinance shall become effective 30 days after enactment.]
- 240261** Amendment/Ordinance/Chapter 50 (Zoning)/Article XXX (Flood Hazard Management)/Section 50-172 (Flood Insurance Study Adopted)
- An ordinance to amend the Flint City Code of Ordinances by amending Chapter 50 (Zoning), Article XXX (Flood Hazard Management), by amending Section 50-172 (Flood Insurance Study Adopted).
- 240264** Amendment/Ordinance/Chapter 50 (Zoning)/Article 18 (Administration and Enforcement)/Section 50-200 (Authority of the Zoning Coordinator)/Section 50-202 (Enforcement Powers)
- An ordinance to amend the Code of the City of Flint by amending Chapter 50 (Zoning), Article 18 (Administration and Enforcement), by amending Section 50-200 (Authority of the Zoning Coordinator) and Section 50-202 (Enforcement Powers).

FINAL COUNCIL COMMENTS

Final Council Comments shall be limited to two (2) minutes.

ADJOURNMENT

240144



RESOLUTION NO.: _____
PRESENTED: 4-17-2024
ADOPTED: _____

**RESOLUTION AUTHORIZING ENTRY INTO ADMINISTRATIVE CONSENT ORDER
BETWEEN THE CITY OF FLINT AND THE STATE OF MICHIGAN, DEPARTMENT OF
ENVIRONMENT, GREAT LAKES AND ENERGY, DRINKING WATER AND
ENVIRONMENTAL HEALTH DIVISION**

BY THE CITY ADMINISTRATOR:

The State of Michigan, Department of Environment, Great Lakes, and Energy ("EGLE"), Drinking Water and Environmental Health Division ("DWEHD") has made allegations that the City of Flint is in violation of the Michigan Safe Drinking Water Act, 1976 PA 399, as amended (Act 399), and the administrative rules promulgated thereunder, being 2009 ACS R 325.10101, *et seq.*, Title XIV of the Public Health Service Act: Safety of Public Water Systems (Safe Drinking Water Act), Title 42 of the United States Code (USC), Section 300f, *et seq.* (collectively, the "SDWA").

The City of Flint is a supplier of water as defined under the SDWA through the City of Flint's ownership and operation of a Class D1 water treatment system and SI water distribution system.

The City of Flint and EGLE have tentatively agreed to resolve the violations alleged by EGLE through entry of an Administrative Consent Order.

The Department of Public Works recommends that the City enter into the Administrative Consent Order to resolve the allegations made by EGLE.

IT IS RESOLVED that the City Council approves authorizing the City of Flint to take all actions necessary to enter into DWEHD Order No. ACO-399-03-2024 ("Administrative Consent Order between the City of Flint and EGLE").

For the City

For the City Council

CLYDE D EDWARDS / AD148
C:\YOE D EDWARDS / A0144 (Rev. 11, 2014) 11 21 ED 11
Clyde Edwards, City Administrator

APPROVED AS TO FORM:

William Y. Kim
William Y. Kim (Rev. 11, 2014) 09 19 EB
William Y. Kim, City Attorney



CITY OF FLINT STAFF REVIEW FORM

TODAY'S DATE: April 9, 2024

BID/PROPOSAL# None.

AGENDA ITEM TITLE: Resolution Authorizing Entry into Administrative Consent Order Between the City of Flint and the State of Michigan, Department of Environment, Great Lakes and Energy, Drinking Water and Environmental Health Division

PREPARED BY: Joseph N. Kuptz, Chief Deputy City Attorney

VENDOR NAME: State of Michigan, Department of Environment, Great Lakes and Energy, Drinking Water and Environmental Health Division

BACKGROUND/SUMMARY OF PROPOSED ACTION:

The State of Michigan, Department of Environment, Great Lakes, and Energy ("EGLE"), Drinking Water and Environment Health Division ("DWEHD") has made allegations that the City of Flint is in violation of the Michigan Safe Drinking Water Act, 1976 PA 399, as amended (Act 399), and the administrative rules promulgated thereunder, being 2009 ACS R 325.10101, et seq., Title XIV of the Public Health Service Act: Safety of Public Water Systems (Safe Drinking Water Act), Title 42 of the United States Code (USC), Section 300f, et seq. (collectively, the "SDWA").

The City of Flint is a supplier of water as defined under the SDWA through the City of Flint's ownership and operation of a Class D1 water treatment system and S1 water distribution system.

The City of Flint and EGLE have tentatively agreed to resolve the violations alleged by EGLE through entry of an Administrative Consent Order.

PREVIOUS ALLOCATIONS (INCLUDE ALL ACCOUNTS USED FOR THIS PURPOSE)/ PROVIDE RESOLUTION OR CONTRACT INFORMATION THAT APPLIES

None.



CITY OF FLINT STAFF REVIEW FORM

BUDGET YEAR 3

OTHER IMPLICATIONS (*i.e., collective bargaining*):

STAFF RECOMMENDATION: (PLEASE SELECT): APPROVED NOT APPROVED

DEPARTMENT HEAD SIGNATURE: CLYDE D EDWARDS / AD148
CLYDE D EDWARDS / AD148 (Apr 11, 2024 11:23 EDT)
Clyde Edwards, City Administrator

240227

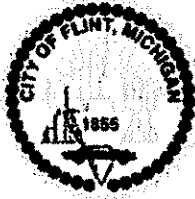

RESOLUTION NO.: _____

PRESENTED: JUN 08 2024

ADOPTED: _____

RESOLUTION APPROVING REALLOCATION OF ARPA FUNDS TO PROCEED WITH GRANTS FOR YOUTH JOB TRAINING FOR FAITH FOUNDATION RESOURCES

BY THE CITY ADMINISTRATION:

In 2022 and 2023, the City of Flint received funds pursuant to the American Rescue Plan Act of 2021 (ARPA), which could be used by the City for specific and defined purposes. In 2023, the City of Flint obligated all of the ARPA funding received, of which approximately \$40 million was obligated as "revenue replacement;"

City Administration recommends reallocating \$200,000 of ARPA funds, previously obligated for revenue replacement, to provide funding to Faith Foundation Resources to provide professional career and educational training skills to youth and young adults ages 16 to 21.

Reallocated funds will be moved from #101-287.000-963.000 as follows:

Account	Description	Amount
101-728.018-801.000	Faith Foundation Resources	\$200,000

IT IS RESOLVED that the appropriate City officials are authorized to do all things necessary, including executing any necessary agreements, to appropriate funding from the funding source account #101-287.000-963.000 to Faith Foundation Resources in the amount of \$200,000. Based on review and validation of the appropriate fund use by the City's compliance firm, implementation of these funds will be consistent and compliant with US Department of Treasury requirements and previously approved authorizations.

For the City:

For the City Council:

Sheldon A. Neeley, Mayor

CLYDE D EDWARDS

C. YDE D EDWARDS (May 29, 2024 11:38 EDT)

Clyde D. Edwards, City Administrator

Approved as to Form:

William Kim (May 28, 2024 14:17 EDT)

William Kim, City Attorney

Approved as to Finance:

Phillip Moore (May 28, 2024 14:34 EDT)

Phillip Moore, Chief Financial Officer



CITY OF FLINT STAFF REVIEW FORM

TODAY'S DATE: 4/10/24

BID/PROPOSAL# A0139

AGENDA ITEM TITLE: RESOLUTION APPROVING REALLOCATION OF ARPA FUNDS TO PROCEED WITH GRANTS FOR YOUTH JOB TRAINING FOR FAITH FOUNDATION RESOURCES

PREPARED BY: Latrese Brown - Community Liaison

VENDOR NAME: Faith Foundation Resources

BACKGROUND/SUMMARY OF PROPOSED ACTION:

Faith Foundation Resources was established in 2003 by its Founder, Angela Lots, a person who recognized the need to have an organization that reached out to adults in need of job training, home ownership and credit education. Faith Foundation Resources is a 501(c)(3) not-for-profit, Faith-Based organization dedicated to providing, low income, marginalized, disenfranchised and at-risk individuals, the tools to get to the next stages in life. "Bridging the Gaps in Life One Mind at a Time".

In 2011 FFR founder recognized the need to service youth after her own teens began to look for after school employment. She taught them the importance of a firm hand shake, the tools of interviewing, how to make a good impression and how to be professional at all times. After successfully assisting her two sons obtain and maintain employment Angela, wanted to help other youth experience the same level of success.

Out of the desire to help youth "bridge the gaps in life" the Faith Foundation Resources Youth Programs were established. Our programs teaches professional communication skills, personal credit development, positive health training, nutrition, and job placement. FFR programs provides training and direction to youth while preparing them for future.

Faith Foundation Resources was selected for funding as a recommendation from the City of Flint Administration. This program would satisfy the Economic Development category in the subcategories of Youth Job Training.

With funding from the ARPA grant 150 youth of Flint will complete the HYPE Program and be placed with employment. The HYPE Program provides professional career and educational training skills to youth and young adults ages 16 to 21. These activities empower youth with the tools to become productive, responsible, self-determined members of society. The program's professional development team teaches HYPE courses over eight weeks. Courses focus on job readiness, learning the fundamentals of interpersonal skills, and financial literacy training, with a significant credit counseling component. Participants meet for 3 to 4 hours each week.

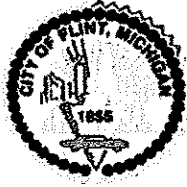

CITY OF FLINT STAFF REVIEW FORM

**PREVIOUS ALLOCATIONS (INCLUDE ALL ACCOUNTS USED FOR THIS PURPOSE)/ PROVIDE
RESOLUTION OR CONTRACT INFORMATION THAT APPLIES**

Faith Foundations Resources received funding from the Community Development Block Grants (CDBG) for five fiscal years.

**POSSIBLE BENEFIT TO THE CITY OF FLINT (RESIDENTS AND/OR CITY OPERATIONS) INCLUDE
PARTNERSHIPS AND COLLABORATIONS:**

The HYPE Program has been successfully helping youth and young adults since 2011. Components that make this program unique and strong to Flint residents include:

- Wrap-around program that includes tracking participants for an entire year.
- Students are placed into jobs that provide year-round employment instead of seasonal work. The staff provides ongoing follow-up to ensure employment remains a positive fit for the participant and the employer partner.
- Financial literacy program not only teaches skills but helps students establish savings and/or checking accounts. This component introduces credit and explains how to develop positive credit profiles with high FICO scores.
- Each student leaves the program with a resume geared toward securing a first-time job.



CITY OF FLINT STAFF REVIEW FORM

FINANCIAL IMPLICATIONS:

In 2022 and 2023, the City of Flint received funds pursuant to the American Rescue Plan Act of 2021 (ARPA), which could be used by the City for specific and defined purposes. In 2023, the City of Flint obligated all of the ARPA funding received, of which approximately \$40 million was obligated as "revenue replacement;"

City Administration recommends reallocating \$200,000 of ARPA funds, previously obligated for revenue replacement, to provide funding to Faith Foundation Resources to provide professional career and educational training skills to youth and young adults ages 16 to 21.

After a thorough analysis from E&Y consulting team, the proposed program complies with relevant Treasury rules and aligns with the Flint ARPA Plan.

BUDGETED EXPENDITURE? YES NO IF NO, PLEASE EXPLAIN:

Dept.	Name of Account	Account Number	Grant Code	Amount
Mayor's Office	Faith Foundations Resources	101-728.018-801.000	Youth Job Training	\$200,000
FY24 GRAND TOTAL				\$200,000

PRE-ENCUMBERED? YES NO REQUISITION NO:

ACCOUNTING APPROVAL: Philip Moore Date: 05/28/2024
Philip Moore (May 28, 2024 14:34 EDT)

WILL YOUR DEPARTMENT NEED A CONTRACT? YES NO



CITY OF FLINT STAFF REVIEW FORM

WHEN APPLICABLE, IF MORE THAN ONE (1) YEAR, PLEASE ESTIMATE TOTAL AMOUNT FOR EACH BUDGET YEAR: *(This will depend on the term of the bid proposal)*

BUDGET YEAR 1 \$200,000

BUDGET YEAR 2

BUDGET YEAR 3

OTHER IMPLICATIONS *(i.e., collective bargaining)*:

STAFF RECOMMENDATION: *(PLEASE SELECT)*: APPROVED NOT APPROVED

DEPARTMENT HEAD SIGNATURE:

Shelly Sparks Green May 28, 2024 19:48 EDT.

(Shelly Sparks-Green, Chief Resilience Officer)

240275



RESOLUTION NO.: _____

PRESENTED: 7-17-2024

ADOPTED: _____

RESOLUTION APPROVING APPOINTMENT OF DOMINIQUE STRONG TO THE FLINT HOUSING COMMISSION

Mayor Sheldon A. Neeley appoints Dominique Strong, of Sherry Drive, Flint, MI 48506, to the Flint Housing Commission, to fill the seat previously held by Dewaun Robinson, for a 5-year term beginning on September 1, 2024 and expiring on August 31, 2029.

BE IT RESOLVED that the Flint City Council approves the appointment of Dominique Strong, of Sherry Drive, Flint, MI 48506, to the Flint Housing Commission for a 5-year term beginning on September 1, 2024 and expiring on August 31, 2029.

FOR THE CITY OF FLINT:

APPROVED BY CITY COUNCIL:

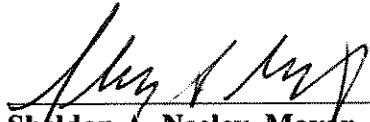

Sheldon A. Neeley, Mayor

APPROVED AS TO FORM:



William Kim, City Attorney

DOMINIQUE STRONG

Flint, MI | 810-280-6776 | mdominique810@gmail.com

PROFESSIONAL WORK HISTORY

Genesee Health System - Flint, MI 2021 to Present **Assisted Outpatient Treatment Program (AOT) Case Manager**

- Assess needs of persons served through utilization of a strength assessment, direct and/or collateral interviews and review of clinical and social information
- Develop, prepare, implement, and monitor an Individualized Plan of Service (IPOS)
- Coordinate services with hospitals, law enforcement, other service providers, and Probate court for individuals served in the AOT program
-

Genesee Health System - Flint, MI 2021 to 2023 **Applied Behavior Analyst Technician**

- Implements applied behavior analysis interventions but may be assigned to other appropriate clinical cases for the provision of ABA.
- Functions as part of an interdisciplinary team and services are delivered both in an outpatient clinic setting and in-home.
- Given responsibilities to participate in the implementation of the ABA benefit for eligible children under the age of 6 years with an autism spectrum disorder diagnosis.

UMA Strong Marshall Outreach and Non-Profit Organization -Flint, MI 2017 to Present **Founder & Executive Director**

- Coordinates Summer Reading 8-week program in partnership with Genesee Intermediate School District's Early Childhood Education Center, for ages five to twelve years of age.
- Supervises Warming Bodies Through Love; Community outreach program providing free winter attire to Flint/Genesee county families.
- Organizes community events and implements youth programming as a park adopter of three City of Flint's parks through Keeping Genesee County Beautiful.
- Coordinates ongoing local program events, rigorous program evaluation, and consistent quality of finance, administration, fundraising, communications, and systems; recommend timelines and resources needed to achieve the strategic goals.

Evergreen Community Development Initiative Non-Profit Organization -Flint, MI 2020 to 2021

Community Outreach Coordinator

- Operated, maintained, and updated youth programs, in partnership with topic-area experts, to engage youth in water testing and community outreach activities.
- Developed communication materials and updated social media accounts with information regarding available programs and events.
- Maintained a calendar of outreach activities, including community events, workshops, appearances, and other communication opportunities.
- Acted as the primary point of contact for the Community Water Lab, maintaining consistent and positive communication with all stakeholders.
- Assisted in the organization of special events and community activities that support the Community Water Lab.
- Stewarded and build relationships with organizations and individual leaders in the community ●

Prepared accurate records and reports on outcomes of programs, events, and outreach activities.

- Collaborated with the Program Manager and Executive Director to consistently evaluate and refine methods for outreach, programming, and evaluation.

Ascension Health – Grand Blanc, MI 2017 to 2020 Certified Nursing Assistant (CNA) - Rehabilitation Unit

- Trained 20+ new nursing assistants on policies, procedures, and daily tasks.
- Utilized a documentation system that increases efficiency in documenting nursing actions.
- Assisted residents with personal care and daily living activities.

Cottage of Davison – Davison, MI 2015 to 2017 Certified Nursing Assistant (CNA)

- Served as Lead Certified Nurse Assistant.
- Noted observations of patient behavior including complaints or physical symptoms to nurses.
- The administered medication under the Registered Nurse License, privately owned.

EDUCATION AND PROFESSIONAL DEVELOPMENT

Bachelor's in Applied Science University of Michigan – Flint (December 2019) Concentration in Social Work & English

Associate's in Applied Science Mott Community College (December 2015) Computer Occupational Technology

Achievement Computer Support Services & Help Desk Mott Community College (December 2015)

Certified Nursing Assistant License State of Michigan (July 2015-2023)

Community Board Member

Community Foundation of Greater Flint- NSGP Committee Member (Jan. 2018- Present)

Flint River Watershed Coalition Board Member (Feb. 2020- Present)

Neighborhood Engagement Hub Board Member (March 2020- Present)

240276



RESOLUTION NO.: _____

PRESENTED: 7-17-2024

ADOPTED: _____

RESOLUTION APPROVING REAPPOINTMENT OF SHERYL D. THOMPSON TO THE BOARD OF DIRECTORS FOR THE VALLEY AREA AGENCY ON AGING

Mayor Sheldon A. Neeley appoints Sheryl D. Thompson, of Crestbrook Lane, Flint, MI 48507, to the Valley Area Agency on Aging Board, to fill the remainder of a two-year ending on December 31, 2025, for the appointment previously held by Dr. Jacquinne Reynolds, whose appointment expired on December 31, 2023, after serving the maximum of four, two-year terms.

BE IT RESOLVED that the Flint City Council approves the appointment of Sheryl D. Thompson, of Crestbrook Lane, Flint, MI 48507, to the Valley Area Agency on Aging Board.

FOR THE CITY OF FLINT:

APPROVED BY CITY COUNCIL:

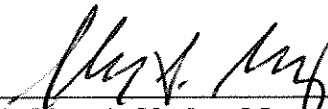

Sheldon A. Neeley, Mayor

APPROVED AS TO FORM:



William Kim, City Attorney

Sheryl D. Thompson
4709 Crestbrook Lane
Flint, MI 48507
810-874-9419
Sheryl.ThompsonLLC@gmail.com

EDUCATION

CENTRAL MICHIGAN UNIVERSITY, MT. PLEASANT, MI

Master of Science in Administration; concentration in Public Administration - August 2000
Bachelor of Social Work Degree - December 1985

Experience:

APRIL 2020- PRESENT

NNA CERTIFIED NOTARY SIGNING AGENT- HERE 4U NOTARY SERVICES, LLC

Work independently with title and mortgage companies as well as third party vendors to meet with borrowers, sellers, and buyers to facilitate paperwork regarding loans, purchases, and sales of real property. Interact with customers from diverse sociocultural, economic, educational, and ethnic backgrounds. Explain the purpose of each document being signed and answer any pertinent questions without giving advice. Specifically trained to handle and work with mortgage lenders, title and escrow companies signing and notarizing mortgage loan documents.

June 1987-November 2020

Michigan Department of Health and Human Services

Over 33 years of experience at the Michigan Department of Health and Human Services (MDHHS) in Genesee County and Central Office Roles. Retired as Deputy Director of Economic Stability Administration.

Development and grants management: Managed over \$50 million in grants for local and state initiatives that impact low income and disadvantaged populations. Developed local and statewide fundraising strategies for the MDHHS.

Strategic planning and facilitation: Led or participated in various strategic planning processes for the MDHHS, Work Force Development Agency, non-profit boards, community schools, and community partners.

Budget management: Background in developing, and monitoring program and organizational budgets, preparing and monitoring contract compliance and expenditures.

Policy development and analysis: Background in assisting local and state government agencies in developing, analyzing, and implementing policy, procedures, and legislative changes.

Advocacy work and constituency building: Extensive experience in articulating the MDHHS mission and vision as they relate to economic, social, and educational development of our disadvantaged population. Created a network of partners to work in tandem to address family barriers and provision of resources to lift families out of poverty.

Human Services: Extensive background as a front-line worker, supervisor and manager, senior executive in all aspects of the human services field. Child Welfare; Children's Protective Services, Foster Care, Juvenile Justice, Adoption. Temporary Assistance to Needy Families (TANF) Programs, Supplemental Nutrition Assistance Program (SNAP), Child Support, Work Force Development & Training.

Communication: Experience in public speaking, media- locally and nationally. Presenter or panelist at local, state, and national conferences on MDHHS initiatives. Experience in providing expert testimony on policy and procedures of Michigan Department of Health and Human Services. Provided two depositions for MDHHS in two major lawsuits. - Dwayne B vs. Granholm and Smith vs. DHS Director

Board Experience: Over 27 years of experience as non-profit board member, chair, and committee member on local and state boards.

September 1989- present

Notary Public – State of Michigan, commission Genesee County

Appointed by the Governor to take acknowledgements, administer oaths, attestations.

of certain documents.

June 1987-November 2020

Michigan Department of Health and Human Services

Over 33 years of experience at the Michigan Department of Health and Human Services (MDHHS) in both local and central office roles.

Development and grants management: Managed over \$50 million in grants for local and state initiatives that impact low income and disadvantaged populations. Developed local and statewide fundraising strategies for the MDHHS.

Strategic planning and facilitation: Led or participated in various strategic planning processes for the MDHHS, Work Force Development Agency, non-profit boards, community schools, and community partners.

Budget management: Background in developing, and monitoring program and organizational budgets, preparing and monitoring contract compliance and expenditures.

Policy development and analysis: Background in assisting local and state government agencies in developing, analyzing and implementing policy, procedures, and legislative changes.

Advocacy work and constituency building: Extensive experience in articulating the MDHHS mission and vision as they relate to economic, social and educational development of our disadvantaged population. Created a network of partners to work in tandem to address family barriers and provision of resources to lift families out of poverty.

Human Services: Extensive background as a front-line worker, supervisor and manager, senior executive in all aspects of the human services field. Child Welfare; Children's Protective Services, Foster Care, Juvenile Justice, Adoption. Temporary Assistance to Needy Families (TANF) Programs, Supplemental Nutrition Assistance Program (SNAP), Child Support, Work Force Development & Training and Adult Services.

Communication: Experience in public speaking, media- locally and nationally. Presenter or panelist at local, state, and national conferences on MDHHS initiatives. Experience in providing expert testimony on policy and procedures of Michigan Department of Health and Human Services. Provided two depositions for MDHHS in two major lawsuits. - Dwayne B vs. Granholm and Smith vs. DHS Director

Board Experience: Over 25 years of experience as a non-profit board member, chair, and committee member on local and state boards.

Training: Provided training to MDHHS and collaborative partners in needed subject areas.

Technology: proficiency in MS word, Power Point, Excel

Management/Staff Development: Experience in human resources- hiring staff, developing position descriptions, performance management, staff career development plans/mentoring, team building. Over 30 mentored staff have been promoted to higher level positions.

Organizational Management: Over 25 years of experience in strategic leadership, organizing, planning and critical decision-making.

Crisis Management: Experience in disaster relief, appointed as Task Force Lead for MDHHS in the Flint Water Crisis in providing resources, Covid19 testing resources.

Volunteer Engagement

- 10/22-present Disaster Responder, American Red Cross
- 10/21-6/22 Flint Water Advisory Council -Chair
- 03-21-present FACT - Ennis Center for Children -Board
- 11/20-present Flint Kids Fund- Advisory member Community Foundation of Greater Flint
- 10/20-present Black Philanthropy Fund Advisory member- Community Foundation -Flint
- 09-20-present Crim Foundation Board of Directors- member
- 06-20-present American Red Cross- ECB Diversity Equity Inclusion- Chair
- 04/20-2021 Flint Covid –19 Response Workgroup
- 03/20-12/22 Statewide Drinking Water Advisory Council-EGLE
- 05/18-present Certified Handler of a Therapy Dog- Mid Michigan Therapy Dogs
- 3-18- present American Red Cross- ECB Board of Directors- Chair
- 2018-2021 Flint Technical Advisory Council Member

240277

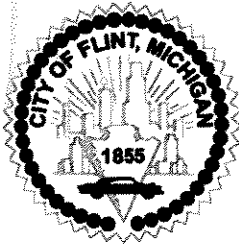

RESOLUTION NO.: _____

PRESENTED: 7-17-2024

ADOPTED: _____

RESOLUTION APPROVING REAPPOINTMENT OF TRACHELLE YOUNG TO THE ETHICS AND ACCOUNTABILITY BOARD

Trachelle Young was first appointed to the EAB in May of 2023 to fill the remainder of a term that expired on June 26, 2024. Mayor Sheldon A. Neeley reappoints Trachelle Young, of Crescent Dr., Flint, MI 48503, to the Ethics and that Accountability Board, to fill a six-year term ending on June 26, 2030.

BE IT RESOLVED that the Flint City Council approves the reappointment of Trachelle Young, of Crescent Dr., Flint, MI 48503, to the Ethics and Accountability Board, to fill a six-year term ending on June 26, 2030.

FOR THE CITY OF FLINT:

APPROVED BY CITY COUNCIL:

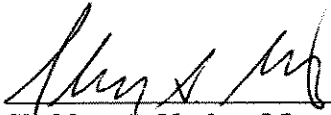

Sheldon A. Neeley, Mayor

APPROVED AS TO FORM:



William Kim, City Attorney

240296

RESOLUTION NO: _____

PRESENTED: 7-17-2024

ADOPTED: _____

**RESOLUTION APPROVING THE REAPPOINTMENT OF
WILLIE BUFORD TO THE ZONING BOARD OF APPEALS**

BY THE CLERK:

Ladel Lewis, 2nd Ward Flint City Councilmember, recommends the reappointment of Willie Buford (3206 Keyes St., Flint, MI 48504) to the Zoning Board of Appeals.

IT IS RESOLVED, the Flint City Council approves the reappointment of Willie Buford to the Zoning Board of Appeals for a 3-year term commencing 9/01/24 and expiring 8/31/2027.

APPROVED AS TO FORM:

APPROVED BY FLINT CITY COUNCIL:

William Kim, Chief Legal Officer

240297

RESOLUTION NO: _____

PRESENTED: 7-17-2024

ADOPTED: _____

**RESOLUTION APPROVING THE REAPPOINTMENT OF
DEREK DOHRMAN TO THE ZONING BOARD OF APPEALS**

BY THE CLERK:

Derek Dohrman's appointment to the Zoning Board of Appeals expired on 9/01/2023, although he continued to serve.

Jerri Winfrey-Carter, 5th Ward Flint City Councilmember, recommends the reappointment of Derek Dohrman (307 Mason St., Flint, MI 48503) to the Zoning Board of Appeals.

IT IS RESOLVED, the Flint City Council approves the reappointment of Derek Dohrman to the Zoning Board of Appeals for a 3-year term commencing immediately, and expiring 8/31/2026.

APPROVED AS TO FORM:

APPROVED BY FLINT CITY COUNCIL:

William Kim, Chief Legal Officer

DEREK DOHRMAN

307 Mason St, Flint, MI 48503 · 810.955.3826
dohrman.derek@gmail.com

PROFESSIONAL EXPERIENCE

2007 – CURRENT

BUSINESS INFORMATION ANALYST II, MCLAREN HEALTH PLAN

Interpret business rules and prepare functional specifications for all information systems. Assist in the enforcement of product, reporting, and service controls and standards, deadlines, and schedules. Define test conditions, create test plans, and conduct tests to ensure business and reporting requirements are met. Monitor system performances and make recommendations for increased efficiency.

EDUCATION

2013

BACHELOR OF SCIENCE – COMPUTER INFORMATION SYSTEMS,
UNIVERSITY OF MICHIGAN - FLINT

2002

HIGH SCHOOL DEGREE,
GRAND BLANC HIGH SCHOOL

COMMUNITY INVOLVEMENT

- **Board member** - Genesee County Historical Society
- **Board Member** - Carriage Town Historic Neighborhood Association
- **Board Member** - Vehicle City Gridiron Classic
- **Commissioner** – Zoning Board of Appeals – 2021 - Current

240298

RESOLUTION NO: _____

PRESENTED: 7-17-2024

ADOPTED: _____

**RESOLUTION APPROVING THE APPOINTMENT OF
BRE'ANNE MORRIS TO THE HUMAN RELATIONS COMMISSION**

BY THE CLERK:

Per the City Charter that went into effect on Jan. 1, 2018, the Human Relations Commission shall be comprised of nine members, one from each ward in the City of Flint; and

Each Council member shall appoint one resident of his or her ward to serve on the Commission, which aims to assist in the elimination of prejudice, hate and discrimination and promote equality in the treatment of all residents; and

Jerri Winfrey-Carter, 5th Ward Flint City Councilmember, recommends the appointment of Bre'anne Morris (626 Copeman Blvd., Flint, MI 48503) to the Human Relations Commission for the remainder of a 3-year term expiring 10/28/26.

IT IS RESOLVED, that the Flint City Council approves the appointment of Bre'anne Morris to the Human Relations Commission for a 3-year term commencing upon adoption of this resolution, and expiring October 28, 2026.

APPROVED AS TO FORM:

APPROVED BY FLINT CITY COUNCIL:

William Kim, Chief Legal Officer

Bre'anne K. Morris

626 Copeman Blvd, Flint, MI 48503

810-965-8800 | bremorris420@gmail.com

Objective

Dedicated and compassionate professional with extensive experience in community engagement, client advocacy, and public service, seeking to contribute to the Human Relations Board. Committed to fostering inclusive and equitable communities through effective communication, strategic planning, and collaborative problem-solving.

Skills

- Training & Development
- Managerial & Leadership Expertise
- Client Assessment & Advocacy
- HIPAA & OSHA Compliance
- Community Outreach & Public Speaking
- Motivational Interviewing & Conflict Resolution
- Strategic Planning & Data Analysis
- Customer Service & Stress Management
- Crisis Intervention & Suicide Prevention

Work Experience

The Outreach Team, Flint, MI

Lead Organizer-Let It Resound Campaign

May 2024 – Currently Working

- Empowering individuals to actively participate in democracy through comprehensive voter education and civic engagement initiatives.
- Advocating for policy changes and strategic partnerships, enhancing the campaign's impact and reach in the community.
- Blending digital campaigns with grassroots mobilization to create a robust and inclusive movement, fostering tangible progress within the community.
- Leading efforts in grassroots connection and community building, uniting diverse voices to collectively imagine and forge a better future.

Deputy Director-Vote Blue Campaign

June 2022 – November 2022

- Trained canvassers for mid-term election campaigns for gubernatorial and congressional candidates.
- Assisted colleagues in mapping geographic areas of voting bloc concentration.
- Supervised canvassers, providing guidance on constituent interactions.

- Provided transportation and supplies for canvassers.
- Collected data for campaign reporting purposes.

Papa Pals, Various Cities, MI

Companion

May 2022 – Currently Working

- Provide companion care to clients aged 5 - 90.
- Transport clients for errands and medical appointments.
- Perform light housekeeping tasks including washing dishes, cleaning floors, and dusting furniture.
- Remind clients to take medications as prescribed by medical providers.

US Census Bureau, Chicago, IL

Census Field Supervisor

May 2020 – November 2020

- Provided mock scenarios for effective conflict resolution.
- Facilitated onboarding and training of new staff.
- Conducted training sessions on documentation procedures for data collection staff.
- Managed supplies distribution and storage.
- Reviewed operational reports and schedules for accuracy and efficiency.
- Set goals and deadlines for the department.

Genesee Health System, Flint, MI

Recovery Coach

May 2011 – March 2012

- Educated clients and community members about mental/physical illness, abuse, medication, and available resources.
- Collaborated with counselors, physicians, and nurses to coordinate treatment and patient needs.
- Acted as client advocate for service coordination and crisis problem resolution.
- Evaluated clients' physical and mental condition through interviews and observation.
- Developed and implemented treatment plans.
- Performed crisis interventions and maintained client-related paperwork.

Education

Grambling State University, Grambling, LA

Bachelor of Science in Psychology

240305



RESOLUTION NO.: _____

PRESENTED: 7-17-2024

ADOPTED: _____

RESOLUTION APPROVING APPOINTMENT OF BRIAN LARKIN TO THE ETHICS AND ACCOUNTABILITY BOARD

Mayor Sheldon A. Neeley appoints Brian Larkin, of Circle Drive, Flint MI 48507, to the Ethics and that Accountability Board, to fill the remainder of a six-year term ending on June 26, 2026, created by the resignation of Frida Williams.

BE IT RESOLVED that the Flint City Council approves the reappointment of Brian Larkin, of Circle Drive, Flint MI 48507, to the Ethics and Accountability Board, to fill the remainder of a six-year term ending on June 26, 2026.

FOR THE CITY OF FLINT:

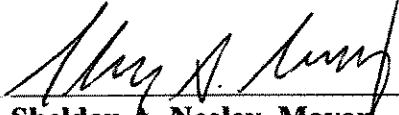

Sheldon A. Neeley, Mayor

APPROVED BY CITY COUNCIL:

APPROVED AS TO FORM:



William Kim, City Attorney

240306

RESOLUTION NO.: _____

PRESENTED: 7-17-2024

ADOPTED: _____

RESOLUTION OF APPROVING THE REAPPOINTMENT OF LINDA K. BOOSE TO THE ETHICS AND ACCOUNTABILITY BOARD

BY THE CITY COUNCIL:

Pursuant to §3-502 of the Flint City Charter (effective January 1, 2018), the Ethics and Accountability Board shall consist of eleven (11) members, with two at-large members appointed by the Mayor, and each Councilperson appointing one resident from their respective ward.

3rd Ward Flint City Councilmember Quincy Murphy recommends the reappointment of Linda K. Boose (2803 Wilton Place, Flint, MI, 48506) to the Ethics and Accountability Board for the remainder of a six (6) year term, with such term commencing immediately and expiring June 25, 2030.

IT IS RESOLVED, that the Flint City Council approves the reappointment of Linda K. Boose (2803 Wilton Place, Flint, MI, 48506) to the Ethics and Accountability Board for the remainder of a six (6) year term, with such term commencing immediately and expiring June 25, 2030.

APPROVED AS TO FORM:

APPROVED BY CITY COUNCIL:

William Kim, Chief Legal Officer

*Linda K. Boose
2803 Wilton Place
Flint, MI 48506
Lindakay48505@yahoo.com
(810) 394-3197*

OBJECTIVE:

To provide citizen representation as a member of the City of Flint Ethic Committee.

EDUCATION:

University of Michigan – Flint, Michigan
Bachelor of Science Degree in Healthcare Administration
Graduated December 2000

Mott Community College – Flint, Michigan
Bachelor of Science – Science Major
Graduated December 1990

Combo Communications – Flint, Michigan
Word Processing Certificate
Completed May 1995

WORK EXPERIENCE:

January 2004 – Present - State of Michigan Department of Health & Human Services Eligibility Specialist. Flint, Michigan. Interview clients to determine eligibility for programs and services; assist low to moderate income individuals and families to become self-sufficient; identify community resources to support the needs of individuals and families.

September 1985 to August 2004 - Flint Public Schools. Flint, Michigan. Guest Teacher Implemented class instruction to student's grade 6th through 12th grade. Taught the Michigan Youth Outreach Curriculum to Middle School Students which educated youth to abstain from drugs, alcohol, tobacco and pre-marital sex.

September 1999-August 2004 – Faith Access to Community Economic Development. Flint, Michigan. Community Outreach Coordinator. (Contractual) Coordinated the MICHild Outreach Program. Supervised Outreach Specialist. Implemented Marketing and promotional activities. Managed application process. Compiled monthly statistical data. Coordinated faith-based church health teams.

February 1998 – March 2003 Hartland Healthcare Center. Flint, Michigan. Admissions/Marketing Director. Reviewed and processed admissions applications; conducted assessments of potential patients; met with patient's families, nursing staff and other Admissions Directors; communicated with Nursing Home Directors and Director of Nursing; Generated monthly and weekly reports; Marketed and promoted nursing home services.

PREVIOUS POSTIONS:

Clara Barton Nursing Home -Nurses Aide
Federal Aviation Administration – Air Traffic Clerk/Recorder
St. Joseph Hospital (Genesee Regional Medical Center) – Marketing Assistance
Volt Energy System – Supervisor/Energy Consultant

CURRENT COMMUNITY AFFILIATIONS:

Alumni Corp – University of Michigan - Flint (formally Alumni Board of Governors)
Genesee County Democratic Party - Secretary
Guest Writer Concerned Pastors for Social Action (CPSA) Courier
Michigan Democratic Party Member
UAW 6000 Health & Safety Representative

PREVIOUS AFFILIATIONS:

Big Brothers Big Sisters Lunch Buddy Mentoring Program/Activity Volunteer
City of Flint City-Wide Advisory Council
City of Flint Human Relations Commission – Commissioner
City of Flint Planning Commission
City of Flint Master Plan Steering Committee
Families of Murdered Children

240240



RESOLUTION NO.: _____

PRESENTED: 6-18-2024

ADOPTED: _____

RESOLUTION APPROVING REALLOCATION OF ARPA FUNDS FOR MENTAL HEALTH REFERRELS AND SERVICES SUPPORT TO FLINT INSTITUTE OF MUSIC FOR \$189,000

In 2022 and 2023, the City of Flint received funds pursuant to the American Rescue Plan Act of 2021 (ARPA), which could be used by the City for specific and defined purposes. In 2023, the City of Flint obligated all the ARPA funding received, of which approximately \$40 million was obligated as “revenue replacement;”

City Administration recommends reallocating \$189,000 of ARPA funds, previously obligated for revenue replacement, to provide funding to Flint Institute of Music (FIM) seeks \$208,000 to expand programming to include drama, dance, and poetry therapy. Structured as 30 to 45-minute sessions of 3-5 youth, this program will use age-appropriate art-informed small group treatment plans to address the cognitive, physical, emotional, and social health-related needs of engaged youth by employing the performing arts within which they have the greatest interest.

***Explanation of Award:** FIM asked for \$208,000 but the committee was over budget, and Admin reduced the amount of this award to remain in alignment with the City Council in the amount of \$1,000,000 from the category of Mental Health Referrals and Support part of Resolution 220464.1, the Proposed ARPA Allocation Plan, on October 24, 2022.

Reallocated funds will be moved from #101-287.000-963.000 as follows:

Account	Description	Amount
101-612.005-801.000	Flint Institute of Music/Mental Health Referrals and Services Support	\$189,000

IT IS RESOLVED that the appropriate City officials are authorized to do all things necessary, including executing any necessary agreements, to appropriate funding from the funding source account #101-287.000-963.000 to Flint Institute of Music in the amount of \$189,000. Based on review and validation of the appropriate fund use by the City’s compliance firm, implementation of these funds will be consistent and compliant with US Department of Treasury requirements and previously approved authorizations.

For the City:

CLYDE D EDWARDS
CLYDE D EDWARDS (Mar 26, 2024 17:07 EDT)

Clyde D. Edwards, City Administrator

For the City Council:

Approved as to Form:

William Kim
William Kim (Mar 26, 2024 10:20 EDT)

William Kim, City Attorney

Approved as to Finance:

Phillip Moore
Phillip Moore (Mar 26, 2024 13:03 EDT)

Phillip Moore, Chief Financial Officer

RESOLUTION STAFF REVIEW

Date: 3/22/2024

Agenda Item Title: RESOLUTION APPROVING REALLOCATION OF ARPA FUNDS FOR MENTAL HEALTH REFERRELS AND SERVICES SUPPORT TO FLINT INSTITUTE OF MUSIC FOR \$189,000

Prepared by: Shelly Sparks-Green

Background/Summary of Proposed Action:

Company History: Flint Institute of Music (FIM) traces its roots to the formation of the Flint Community Music Association (FCMA) under the leadership of automotive pioneer and philanthropist J. Dallas Dort. As early as 1913, with Dort's influence and financial backing the he enjoyed singing. Anyone who was interested, regardless of age, gender, race, religion, financial status or even ability was welcome and invited to participate.

As Flint grew and prospered post World War II, civic leaders demonstrated enthusiasm to upgrade all the cultural offerings in the newly forming cultural center campus. This included plans for the construction of an orchestra hall, Whiting Auditorium which would open May 1, 1967. Just as J. Dallas Dort had been instrumental in the formation of FCMA, his son David Dort would play a significant role in transiting the Flint Symphony Orchestra to the status of a professional orchestra.

In 1965, the Musical Performing Arts Association (MPAA) was formed to professionalize the Flint Symphony Orchestra and soon afterward hired its first professional conductor, William Byrd. While accomplishing the main objective the MPAA soon found itself competing with FCMA for limited community resources including the highly qualified volunteer leadership required to steward two esteemed organizations. Not long after, both organizations experiencing similar challenges, agreed to merge as the Flint Institute of Music in 1971. It was a sound move with strong community support and led to significant programmatic and creative growth, including the formation of the FIM Community Music School, later renamed Flint School of Performing Arts (1986). In 2009 FIM accepted leadership and management of the Flint Youth Theatre originally founded in 1957.

Defined Problem: Based upon the US Census Bureau definition of minority, a “population of people who are not single-race white and not Hispanic”, this project is not designed for the direct benefit of any minority population. However, under a more evolved definition set forth by the University of Chicago and American Sociological Association, “a group of people...singled out from the others in society which they live for differential and unequal treatment, and who therefore regard themselves as objects of collective discrimination...based on an individual's physical or behavioral characteristics”, yes, this project will directly benefit a minority population – youth with mental health issues.

We are all aware of the stigma attached to compromised mental health, but that awareness does not often extend to youth. Research performed by the American Music Therapy Association, published in the Journal of Music Therapy, 54(2), 2017, 133–160 highlighted that “mental health disorders

form the greatest burden of disease for young people internationally, with half of all lifetime disorders beginning by age 14”, and the CDC reports suicide as the second leading cause of death for youth ages 10-14.

Our children are not well. Because youth aged 10-14 makeup the smallest class of suicides by age group, it is often overlooked that, according to the CDC, for every suicide death, there are:
4 hospitalizations for suicide attempts
8 emergency visits related to suicide
27 self-reported suicide attempts, and
275 people who seriously consider suicide

In the wake of the COVID-19 pandemic, concern for our youth has spiked. Forced isolation, increased anxiety, and the influences of social media/popular culture, coupled with a lack of knowledge regarding adolescent mental health and a lack of sufficient resources have exacerbated an already volatile situation.

Funding Purpose: Currently utilizing group instrument play, structured music listening, lyric analysis, songwriting, and music & movement to address mental health and behavioral outcomes of participating students, FIM seeks \$208,000 to expand programming to include drama, dance, and poetry therapy.

Structured as 30 to 45-minute sessions of 3-5 youth, this program will use age-appropriate art-informed small group treatment plans to address the cognitive, physical, emotional, and social health-related needs of engaged youth by employing the performing arts within which they have the greatest interest.

Serving 375 K-12 youth with the goals of increasing emotional regulation, teaching healthy coping skills, increasing youth on-task behaviors & sustained attention skills, while improving peer-to-peer interactions amongst youth, by the close of the 3-year grant term, FIM Art-Informed Therapy will see:

- 75% of students able to identify a minimum of two de-escalation techniques for reducing frustration/anger
- 80% of students having improved their focus and on-task behavior
- 70% of students will have improved their overall peer-to-peer interactions

Present Day: Today, FIM offers a wide array of performances through its artistic division which includes the Flint Symphony Orchestra, Flint Repertory Theatre, FIM presenting series at Whiting Auditorium and Capitol Theatre and Movies at the Capitol Theatre. In addition, FIM provides extensive community education and engagement opportunities including long-standing favorites, Music Around Town and the Troubadours. FIM Flint School of Performing Arts, one of the largest community schools of the arts in the nation, provides music, dance & theater instruction, and performance opportunities for students of all ages and abilities.

FIM operates five performance venues, four situated on the Flint Cultural Center Campus— Whiting Auditorium, Elgood Theatre, Bower Theatre, MacArthur Recital Hall. Its fifth venue is the recently renovated, historic Capitol Theatre in downtown Flint. FIM venues host its own

artistic productions, hundreds of student recitals, community events, rentals, and touring presentations from all over the world and reach more than 300,000 people annually through lessons, classes, outreach programs, and performances. Our community programs delivers Summer Delights with Music Around Town, just another way FIM brings the transformative power of the performing arts to the greater Flint area. Musical ensembles of all types and sizes share their talents and entertain audiences from June through August. Watch your email or follow our Facebook pages for more information on our summer schedule.

In the past year, FIM Music Therapy Program served 213 youth and added 5 new sites. 75% of those students identified at least 2 de-escalation techniques for reducing frustration/anger; 82% improved their focus and on-task behavior; and 97% improved their overall peer-to-peer interactions.

Program Outcomes: Seeking to build upon those outcomes, FIM Art-Informed Therapy is a proposed expansion that will utilize the intellectual and artistic gifts of Board-Certified Music Therapists, Certified Behavior Specialists, and/or Board-Certified Behavior Analysts with a background/experience in dance, theatre, music, and/or poetry. These Board-Certified Professionals will utilize the performing arts to help youth develop healthy processing skills and heal in a safe space promoting mindfulness and creativity. The use of the performing arts to enhance mental health is rooted in the idea that creative expression improves overall well-being - a belief upon which the Flint Institute of Music was founded.

Account	Description	Amount
101-612.005-801.000	Flint Institute of Music/Mental Health Referrals and Services Support	\$189,000

Financial Implications:

American Rescue Plan Act funds must be fully expended by 12/31/26.

Budgeted Expenditure: Yes ___ No X **Please explain, if no:**
Pre-encumbered: Yes ___ No X **Requisition #:** N/A
Other Implications: No other implications are known at this time.
Staff Recommendation: Staff recommends approval of this resolution.

APPROVAL Shelly Sparks-Green
Shelly Sparks-Green / Mar 26, 2024 16:15 EDT
Shelly Sparks-Green, Chief Resilience Officer



240241

RESOLUTION NO.: _____

PRESENTED: 10-18-2024

ADOPTED: _____

RESOLUTION APPROVING REALLOCATION OF ARPA FUNDS TO PROCEED WITH RESOLUTION TO UTILIZE ARPA FUNDS TO RESPOND TO THE IMPACTS OF THE PANDEMIC ON HOUSING FOR FLINT HOMEOWNERS – CONTRACT WITH HABITAT OF HUMANITIES FOR HOMEOWNER EDUCATION ASSISTANCE

BY THE CITY ADMINISTRATION:

In 2022 and 2023, the City of Flint received funds pursuant to the American Rescue Plan Act of 2021 (ARPA), which could be used by the City for specific and defined purposes. In 2023, the City of Flint obligated all of the ARPA funding received, of which approximately \$40 million was obligated as “revenue replacement;”

City Administration recommends reallocating \$50,000 of ARPA funds, previously obligated for revenue replacement, to provide funding to Genesee County Habitat for Humanity (GCHFH) to serve City of Flint Residents through their HUD Certified Housing Counseling Program.

Reallocated funds will be moved from #101-287.000-963.000 as follows:

Account	Description	Amount
101-729.004-801.000	Genesee County Habitat for Humanity (GCHFH)	\$50,000

IT IS RESOLVED that the appropriate City officials are authorized to do all things necessary, including executing any necessary agreements, to appropriate funding from the funding source account #101-287.000-963.000 to Genesee County Habitat for Humanity (GCHFH) in the amount of \$50,000. Based on review and validation of the appropriate fund use by the City’s compliance firm, implementation of these funds will be consistent and compliant with US Department of Treasury requirements and previously approved authorizations.

For the City:

For the City Council:

CLYDE D EDWARDS

CLYDE D EDWARDS (Mar 26, 2024 12:20 EDT)

Clyde D. Edwards, City Administrator

Approved as to Form:

Approved as to Finance:

William Kim

William Kim (Mar 26, 2024 10:19 EDT)

William Kim, City Attorney

Phillip Moore

Phillip Moore (Mar 26, 2024 12:16 EDT)

Phillip Moore, Chief Financial Officer

RESOLUTION STAFF REVIEW

Date: March 19, 2024

Agenda Item Title:

RESOLUTION APPROVING REALLOCATION OF ARPA FUNDS TO PROCEED WITH RESOLUTION TO UTILIZE ARPA FUNDS TO RESPOND TO THE IMPACTS OF THE PANDEMIC ON HOUSING FOR FLINT HOMEOWNERS – CONTRACT WITH HABITAT OF HUMANITIES FOR HOMEOWNER EDUCATION ASSISTANCE

Prepared by:

Latrese Brown, Community Liaison

Background/Summary of Proposed Action:

Genesee County Habitat for Humanity (GCHFH): Funding request and purpose: Requesting \$50,000 for Homeowner Education;

Genesee County Habitat for Humanity (GCHFH) will continue to serve City of Flint Residents through their HUD Certified Housing Counseling Program. The focus for this funding opportunity will be low-to-moderate households participating in their in-person Fair Housing and Intro to Homebuyer Education Class. Those residents who complete the course, as well as a financial intake assessment, and purchase a home in the City of Flint through the Genesee County Land Bank Authority (GCLBA) will be eligible for \$500.00 down payment assistance. This class is required by the GCLBA and GCHFH currently offers the class twice a month. The goal will be for 120 eligible City of Flint residents to complete the course and 30 home sales in the City of Flint to utilize the down payment assistance.

GCHFH is helping to end the cycle of poverty in the City of Flint by providing education and financial tools needed to improve one's life. Financial Literacy through education can help lift people out of poverty by teaching them how to manage money and build wealth through homeownership. People benefit most from Homeowner Education when the support is appropriate to their needs and easily accessible, which is the intent of our program. We track all program data through our HUD approved client management system, CounselorMax. The client's data is collected including family composition, demographic information, and income.

History:

Founded in 1990, Genesee County Habitat for Humanity (GCHFH) is one of nearly 1,400 United States affiliates of Habitat for Humanity International. Habitat for Humanity partners with people in your community, and all over the world, to help them build or improve a place they can call home. Habitat homeowners help build their own homes alongside volunteers and pay an affordable mortgage. With your support, Habitat homeowners achieve the strength, stability, and

independence they need to build a better life for themselves and their families. Through its 2020 Strategic Plan, Habitat for Humanity will serve more people than ever before through decent and affordable housing.

Account	Description	Amount
101-729.004-801.000	Genesee County Habitat for Humanity (GCHFH)	\$50,000

Financial Implications:

American Rescue Plan Act funds must be fully expended by 12/31/26.

Budgeted Expenditure: Yes ___ No X Please explain, if no:
Pre-encumbered: Yes ___ No X Requisition #: N/A
Other Implications: No other implications are known at this time.
Staff Recommendation: Staff recommends approval of this resolution.

APPROVAL Shelly Sparks-Green
Shelly Sparks-Green (Mar 26, 2024 12:19 EDT)
Shelly Sparks-Green, Chief Resilience Officer

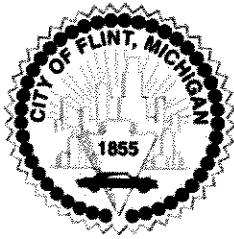

RESOLUTION NO.: 240272

PRESENTED: 7-17-2024

ADOPTED: _____

BY THE CITY ADMINISTRATOR:

RESOLUTION TO APPROVE TENTATIVE AGREEMENT BETWEEN THE CITY OF FLINT AND AFSCME COUNCIL 925, LOCAL 1799

The City of Flint and AFSCME Local 1799 negotiated a Collective Bargaining Wage Equity Reopener Agreement on September 29, 2023.

The parties have reached a Tentative Agreement regarding the Wage Equity Reopener Agreement through June 30, 2025, that includes wage increases for the (8) classifications as outlined in the attached Memorandum of Understanding.

It is the recommendation of the Human Resources and Labor Relations Director, along with the City Administrator, to ratify the Tentative Agreement.

IT IS RESOLVED that the Flint City Council **RATIFIES** the Tentative Agreement between the City of Flint and AFSCME Local 1799, and authorizes the Director, Human Resources & Labor Relation, to execute a Memorandum of Understanding so providing.

APPROVED AS TO FORM:

Signature: 
William Kim (Jul 8, 2024 16:27 EDT)
Email: wkim@cityofflint.com
William Kim, City Attorney

APPROVED AS TO FINANCE:

Signature: 
Phillip Moore (Jul 9, 2024 09:49 EDT)
Email: pmoore@cityofflint.com
Phillip Moore, Chief Financial Officer

FOR THE CITY OF FLINT:

Signature: CLYDE D EDWARDS / A0247
CLYDE D EDWARDS / A0247 (Jul 9, 2024 11:04 EDT)
Email: cedwards@cityofflint.com
Clyde Edwards, City Administrator

APPROVED BY CITY COUNCIL:



CITY OF FLINT

#A0247-RESOLUTION STAFF REVIEW FORM

TODAY'S DATE: 6/12/2024

AGENDA ITEM TITLE: Collective Bargaining Agreement between the City of Flint and AFSCME Michigan Council 925, Local 1799 Wage Reopener.

PREPARED BY: Tia Lewis, Human Resources Manager
(Please type name and Department)

VENDOR NAME: N/A

BACKGROUND/SUMMARY OF PROPOSED ACTION:

Flint City Council approved a collective bargaining agreement between the City of Flint and Local 1799 effective on September 29, 2023. The terms of the agreement allow either party to reopen the agreement for the sole purpose of negotiating wage rate adjustments for no more than eight (8) classifications as outlined in the attached Memorandum of Understanding.

Under the October 15, 2023, provision, all parties bargained and reached an agreement regarding wage rate adjustments for the following eight (8) classifications:

1. Deputy Assessor, Level 29 (1 Employee)
2. Water Plant Maintenance Supervisor, Level 26 (1 Employee)
3. Sewer Cleaning Foreman, Level 26 (1 Employee)
4. Sewer Systems Construction Foreman, Level 26 (2 Employees)
5. Street Maintenance & Construction Foreman, Level 26 (3 Employees)
6. Water Distribution Foreman, Level 26 (4 Employees)
7. Water Plant Operations Foreman, Level 26 (4 Employees)
8. Election Information & Operations Supervisor (1 Employee)

Funding is available and will be paid from the appropriate wage account numbers according to each employee's individual primary general ledger account number as assigned in the payroll system.

This agreement will extend the local 1799 AFSCME contract through June 30, 2025.



CITY OF FLINT

FINANCIAL IMPLICATIONS: \$138,736.00 additional base wage cost through the expiration of CBA (June 30, 2025). This estimate is based on current bargaining unit employees and includes an estimate for increases to the wage rate for regular hours for the eight (8) specified positions.

ACCOUNTING APPROVAL:

STAFF RECOMMENDATIONS (PLEASE SELECT): **APPROVED** **NOT APPROVED**

DEPARTMENT HEAD SIGNATURE: *Eddie L. Smith*

(Eddie Smith, Director of Human Resources and Labor Relations)

MEMORANDUM OF UNDERSTANDING
Between
City of Flint
And
AFSCME Michigan Council 925, Local 1799

Wage Equity Reopener

This **Memorandum of Understanding** is entered into on March 5, 2024, by and between the City of Flint (Employer) and AFSCME Michigan Council 925, Local 1799 (“Union”).

RECITALS

WHEREAS, the Employer and the Union are parties to a collective bargaining agreement (CBA) effective through June 30, 2025; and

WHEREAS, said CBA provided the following provision(s) regarding Wage Equity Reopeners, and is as follows:

Wage Equity Reopeners. On October 15, 2023, and on September 1, 2024, either party may reopen this Agreement, by providing thirty (30) days advance written notice to the other, for the sole purpose of negotiating wage rate adjustments for identified job classifications, informed by wage comparison data. The parties will meet promptly upon receipt of notice to identify the information needed for negotiation. A party may identify no more than eight (8) classifications for negotiation under this provision in any year; and

WHEREAS, the Employer and the Union scheduled several sessions to meet and confer (negotiate) with respect to possible adjustments to the wage/salary rates for the Unions (8) selected classifications; and

WHEREAS, the parties bargained and reached agreement regarding salary adjustments for the eight (8) Union classification(s) on March 5, 2024 i.e., pursuant to the provisions above; and

WHEREAS, the eight (8) classifications identified and reviewed for wage equity adjustments are:

- Deputy Assessor, Level 29 (1 employee)
- Water Plant Maintenance Supervisor, Level 26 (1 employees)
- Sewer Cleaning Foreman, Level 26 (1 employee)
- Sewer System Construction Foreman, Level 26 (2 employees)
- Street Maintenance & Construction Foreman, Level 26 (3 employees)
- Water Distribution Foreman, Level 26 (4 employees)
- Water Plant Operations Foreman, Level 26 (4 employees)
- Election Information & Operations Supervisor (1 employees)

NOW THEREFORE, the Employer and the Union comprehensively utilized internal & external wage data of comparable positions from local and other surrounding municipalities to determine salary adjustments and the parties agree as follows:

Deputy Assessor Level 29 to Level 37				
Incumbent Position	Step/Year on Wage Scale	Current Hourly Level	Future Hourly Level	Rate Change
Deputy Assessor	25th Year and Over	\$35,216	\$48,135	\$12,919
Water Plant Maintenance Supervisor Level 26 to Level 32				
Water Plant Maintenance Supervisor	21st thru 24th Year	31,594	\$38.15	\$6,556
DPW Foreman Level 26 to Level 29				
Sewer Cleaning Foreman	25th Year and Over	\$32,186	\$35,216	\$3,030
Sewer System Construction Foreman	25th Year and Over	\$32,186	\$35,216	\$3,030
Sewer System Construction Foreman	16th thru 20th Year	\$31,240	\$34,391	\$3,151
Street Maint & Const Foreman	25th Year and Over	\$32,186	\$35,216	\$3,030
Street Maint & Const Foreman	25th Year and Over	\$32,186	\$35,216	\$3,030
Street Maint & Const Foreman	25th Year and Over	\$32,186	\$35,216	\$3,030
Water Distribution Foreman	25th Year and Over	\$32,186	\$35,216	\$3,030
Water Distribution Foreman	25th Year and Over	\$32,186	\$35,216	\$3,030
Water Distribution Foreman	16th thru 20th Year	\$31,240	\$34,391	\$3,151
Water Distribution Foreman	16th thru 20th Year	\$31,240	\$34,391	\$3,151
Water Plant Operations Foreman	5th Year	\$30,575	\$33,641	\$3,066
Water Plant Operations Foreman	5th Year	\$30,575	\$33,641	\$3,066
Water Plant Operations Foreman	5th Year	\$30,575	\$33,641	\$3,066
Water Plant Operations Foreman	5th Year	\$30,575	\$33,641	\$3,066
Election Info & Ops Supervisor Level 22A to Level 24				
Election Info & Ops Supervisor	25th Year and Over	\$26,070	\$30,368	\$4,298

This agreement is set to be effective for the first full pay after March 17, 2024.

AFSCME Local 1799

City of Flint

240278

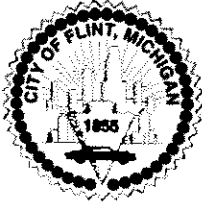

RESOLUTION NO.: _____

PRESENTED: 7-17-2024

ADOPTED: _____

RESOLUTION TO AUTHORIZE, ACCEPT AND SPEND THE FIREMAN’S CHALLENGE TOURNAMENT DONATION CHECK AND CASH RECEIVED FROM PI KAPPA ALPHA FRATERNITY, ZETA ALPHA B CHAPTER AT KETTERING UNIVERSITY FLINT, MI IN THE AMOUNT OF \$3,269.00.

BY THE CITY ADMINISTRATOR:

WHEREAS, the city of Flint Fire Department received a donation check in the amount of \$3,233.00 and cash in the amount of \$36.00 from PI KAPPA ALPHA FRATERNITY, ZETA ALPHA B CHAPTER at Kettering University. The fundraising event, Fireman’s Challenge, a philanthropic tournament, occurred May 20-25, 2024 outside of the Kettering University Campus, 1700 University Avenue Flint MI 48504.

WHEREAS, the Fireman’s Challenge Philanthropic Tournament was an event held by PI KAPPA ALPHA FRATERNITY, ZETA ALPHA B CHAPTER for fundraising for the Flint Fire Department.

Account Number & Grant Code	Account Name	Amount
296-337.999-752.000 & OPKA-FRCHDN	FIRE – SUPPLIES	\$3,269.00
	FY2025 TOTAL:	\$3,269.00

IT IS RESOLVED, that the appropriate City Officials are authorized to do all things necessary to accept the Fireman’s Challenge donation check and cash received from PI KAPPA ALPHA FRATERNITY, ZETA ALPHA B CHAPTER at Kettering University, amend the FY25 budget, appropriate funding for revenue and expenditures for the FY25 budget year in the amount of \$3,269.00 and to record the donation revenue with grant code OPKA-FRCHDN.

APPROVED AS TO FORM:

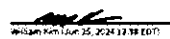
William Kim (Jun 25, 2024 12:18 EDT)

William Kim, Chief Legal Officer

APPROVED AS TO FINANCE:

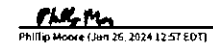
Phillip Moore (Jun 25, 2024 12:57 EDT)

Phillip Moore, Chief Financial Officer

FOR THE CITY OF FLINT:

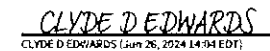
CLYDE D EDWARDS (Jun 26, 2024 14:04 EDT)

Clyde Edwards, City Administrator

APPROVED BY CITY COUNCIL:



CITY OF FLINT

STAFF REVIEW FORM

DATE: June 24, 2024

AGENDA ITEM TITLE: Resolution to authorize, accept and spend the Fireman’s Challenge Tournament donation check in the amount of \$3,233.00 and \$36.00 cash received from Pi Kappa Alpha fraternity at Kettering University for a total of \$3,269.00

PREPARED BY: Karen Shim, Flint Fire Department

BACKGROUND/SUMMARY OF PROPOSED ACTION:

The Flint Fire Department is requesting approval for the acceptance and spending of a donation check made payable to the Flint Fire Department in the amount of \$3,233.00 and \$36.00 cash from the Pi Kappa Alpha Fraternity at Kettering University, Flint, MI. Check and cash were received on June 15, 2024. The Fireman’s Challenge Philanthropic Tournament was an event held during the week of May 20 – 25, 2024 for fundraising for the Flint Fire Department. Said donation funds received are to be appropriated to the designated Fire Supplies account under grant code OPKA-FRCHDN and become available for expenditure for supplies for the Flint Fire Department in FY25.

FINANCIAL IMPLICATIONS: None.

The total amount of \$3,269.00 will be recorded under account name, Donation 296-337.999-675.100 with grant code OPKA-FRCHDN and will be added to the budget in department.

BUDGETED EXPENDITURE? YES NO **IF NO, PLEASE EXPLAIN:**

A donation check and cash were received on June 15, 2023

Dept.	Name of Account	Account Number	Grant Code	Amount
FIRE	SUPPLIES	296-337.999-752.000	OPKA-FRCHDN	\$3,269.00
FY25 GRAND TOTAL				\$3,269.00

PRE-ENCUMBERED? YES NO **REQUISITION NO:** _____

ACCOUNTING APPROVAL: Karen Shim **Date:** June 24, 2024

ACCOUNTING APPROVAL: **Date:** _____
Chay Linseman, Budget and Grants Administrator

WILL YOUR DEPARTMENT NEED A CONTRACT? YES NO
(If yes, please indicate how many years for the contract) _____ YEARS



CITY OF FLINT

WHEN APPLICABLE, IF MORE THAN ONE (1) YEAR, PLEASE ESTIMATE TOTAL AMOUNT FOR EACH BUDGET YEAR: *(This will depend on the term of the bid proposal)*

BUDGET YEAR 1

BUDGET YEAR 2

BUDGET YEAR 3

OTHER IMPLICATIONS *(i.e., collective bargaining)*:

STAFF RECOMMENDATION: *(PLEASE SELECT)*: **APPROVED** **NOT APPROVED**

DEPARTMENT HEAD SIGNATURE: Theron S. Wiggins
Theron S. Wiggins (Jun 25, 2024 09:20 EDT)
Theron S. Wiggins, Fire Chief

PI KAPPA ALPHA FRATERNITY
ZETA ALPHA B CHAPTER
1484 N LINDEN RD
FLINT, MI 48532

9-32/720

1175

DATE: 6-5-2024

PAY TO THE
ORDER OF

FLINT FIRE DEPARTMENT

\$ 3233.00

THREE - THOUSAND TWO - HUNDRED THIRTY - THREE + 00/100 DOLLARS

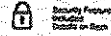

CHASE

JPMorgan Chase Bank, N.A.
www.Chase.com

MEMO FIREMAN'S CHALLENGE - 2024

On P. Poroto

⑆072000326⑆

88095026⑆⑆1175

CASH ENVELOPE

BETTER RATES, BETTER SERVICE.

- Great Loan Rates - Apply Anytime, on Any Device
- Genius High Yield Checking with Rewards
- Credit and Debit Rewards
- Convenient Mobile Banking Apps
- Over 30,000 Surcharge-Free ATMs
- 5-Star Bauer Financial Rating



Where you come first.



**INSURED
BY NCUA**

www.genisyscu.org

200

FEDERAL

JJ 70041313

J10



THIS NOTE IS LEGAL TENDER
FOR ALL DEBTS. PUBLIC AND PRIVATE

Car. Sanatate. Cia



RESOLUTION NO.: 240279

PRESENTED: 7-17-2024

ADOPTED: _____

Resolution Authorizing accepting the grant Continuing Professional Education (CPE) from the State of Michigan Commission on Law Enforcement Standards in the amount of \$49,500.00.

BY THE CITY ADMINISTRATOR:

WHEREAS, The City of Flint Police Department has been awarded funds, in the amount of \$49,500.00, from State of Michigan for the purpose of in-service training for licensed law enforcement officers employed by the City; and

WHEREAS, The Michigan Legislature recognized the importance of continuing education for law enforcement and enacted PA1 to appropriately fund the initiative; and

WHEREAS, The City of Flint Police Department will benefit from the funds to offset the cost of the new continuing professional education required by the State of Michigan commission on Law Enforcement Standards;

Account Number	Grant Code	Account Name	Amount
296-325.200-958.000	SMLES-CPE24	Education, Training & Confer	\$49,500.00

IT IS RESOLVED, that the appropriate City officials are hereby authorized to do all things necessary to accept the funds enacted by Michigan Legislature PA1, amend the FY24 and FY25 budgets, appropriate award funding for revenue and expenditures in future fiscal years as long as the funds are available from the funder, and abide by the terms and conditions of the award from the State of Michigan, in the amount of \$49,500, to grant code SMLES-CPE24.

APPROVED AS TO FORM:

William Kim
William Kim (Jul 9, 2024 17:02 EDT)

William Kim, Chief Legal Officer

APPROVED AS TO FINANCE:

Phillip Moore
Phillip Moore (Jul 10, 2024 09:21 EDT)

Phillip Moore, Chief Financial Officer

FOR THE CITY OF FLINT:

Clyde D. Edwards / A0249
CLYDE D EDWARDS / A0249 (Jul 10, 2024 09:04 EDT)

Clyde Edwards, City Administrator

APPROVED BY CITY COUNCIL:

, City Council President

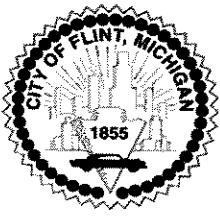

CITY OF FLINT STAFF REVIEW FORM

Revised July 2, 2024

TODAY'S DATE: 07/02/24

BID/PROPOSAL# N/A

AGENDA ITEM TITLE: Resolution Authorizing accepting the grant Continuing Professional Education (CPE) from the State of Michigan Commission on Law Enforcement Standards in the amount of \$49,500.00.

PREPARED BY: Angela Amerman

VENDOR NAME: State of Michigan

Section I: BACKGROUND/SUMMARY OF PROPOSED ACTION:

The Police Department would like to accept the \$49,500.00 from the State of Michigan Commission on Law Enforcement Standards.

Section II. PREVIOUS ALLOCATIONS (INCLUDE ALL ACCOUNTS USED FOR THIS PURPOSE)/ PROVIDE RESOLUTION OR CONTRACT INFORMATION THAT APPLIES

The Michigan Legislature recognized the importance of continuing education for law enforcement and enacted PA1 to appropriately fund this initiative.

Section III. POSSIBLE BENEFIT TO THE CITY OF FLINT (RESIDENTS AND/OR CITY OPERATIONS) INCLUDE PARTNERSHIPS AND COLLABORATIONS:

The Police department will benefit from the funds to offset the cost of new continuing professional education requirements required by the State of Michigan Commission on Law Enforcement Standards.

Section IV: FINANCIAL IMPLICATIONS:

This would increase the funds available for continuing education for licensed law enforcement officers employed by the City.

BUDGETED EXPENDITURE? YES NO **IF NO, PLEASE EXPLAIN:**



CITY OF FLINT STAFF REVIEW FORM

Revised July 2, 2024

Dept.	Name of Account	Account Number	Grant Code	Amount
Police	Education, Training, & Conference	296-326.200-958.000	SMLES-CPE24	\$49,500
			FY24/FY25 GRAND TOTAL	\$49,500

PRE-ENCUMBERED? YES NO REQUISITION NO:

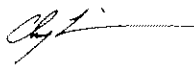
ACCOUNTING APPROVAL:  Date: _____

WILL YOUR DEPARTMENT NEED A CONTRACT? YES NO

WHEN APPLICABLE, IF MORE THAN ONE (1) YEAR, PLEASE ESTIMATE TOTAL AMOUNT FOR EACH BUDGET YEAR: *(This will depend on the term of the bid proposal)*

BUDGET YEAR 1 \$

BUDGET YEAR 2

BUDGET YEAR 3

OTHER IMPLICATIONS *(i.e., collective bargaining)*:

STAFF RECOMMENDATION: *(PLEASE SELECT)*: **APPROVED** **NOT APPROVED**

DEPARTMENT HEAD SIGNATURE: 
Terence Green (Jul 9, 2024 16:55 EDT)
(Terence Green, Police Chief)



GRETCHEN WHITMER
GOVERNOR

STATE OF MICHIGAN
MICHIGAN COMMISSION ON LAW ENFORCEMENT STANDARDS
LANSING

TIMOTHY BOURGEOIS
EXECUTIVE DIRECTOR

June 10, 2024

Dear Law Enforcement Community,

On January 31, 2023, Public Act 1 of 2023 (PA1) appropriated funds to support the implementation of required annual in-service training standards for all licensed law enforcement officers in accordance with rules promulgated under section 11(2) of the MCOLES Act (1965 PA 203, MCL 28.611). Although the Commission has always had the authority to require in-service training, the lack of funding made it unfeasible for the Commission to implement annual in-service training requirements. The Michigan Legislature recognized the importance of continuing education for law enforcement and enacted PA1 to appropriately fund this initiative. Consequently, the Commission is following the direction and intent of the Michigan Legislature and the MCOLES Act to promulgate rules with respect to mandatory in-service training.

Based on research and consistent with in-service training requirements around the country, the Commission is implementing in-service training requirements for all licensed law enforcement officers in Michigan, with a **3-year pilot program beginning in June of 2024**. Going forward, the required in-service training requirements will be referred to as Continuing Professional Education, or CPE.

CPE Pilot Program

As with many other new programs, CPE is currently in a pilot phase which allows for adjustments and modifications as needed. Since we are well into the 2024 calendar year, the Commission is implementing the CPE pilot program with a reduced number of required hours beginning in June 2024.

Accordingly, **the CPE requirement for 2024 is a total of 12 hours** as follows:

- 4 hours of Commission designated training categories; and
- 8 hours of agency selected training categories as per guidelines

The CPE requirement starting in 2025 will be a projected total of 24 hours as follows:

- 8 hours of Commission designated training categories; and
- 16 hours of agency selected training categories as per guidelines

For your convenience, the Commission has created a dedicated CPE webpage [michigan.gov/mcoles] that includes *Frequently Asked Questions* and a *Quick Reference Guide*.

Director Kimberly Koster, Chair • Sheriff Anthony Wickersham, Vice-Chair • Lt. Col. Michael Krumm representing Colonel James Grady
Deputy Matthew Hartig • Mr. Michael Wendling • Mr. David Tanay representing Attorney General Dana Nessel • Officer Linda Broden • Tpr. Nate Johnson
Mr. Arthur Weiss • Second Assistant Chief Grant Ha representing Chief James E. White • Ms. Chiante Lymon • Dr. Lisa R. Jackson • Lt. Michael Hawkins
Mr. Kenneth Grabowski • Mr. Michael Sauger • Sheriff Matthew Saxton • Mr. James Stachowski • Deputy Director Ronald Wiles • Chief Issa Shahin
Pastor Tellis J. Chapman • Pastor Jeffery A. Hawkins • Sheriff Gregory Zyburz • Mr. Anthony D. Lewis representing Mr. John E. Johnson

927 Centennial Way
Lansing, MI 48913
www.michigan.gov/mcoles
517-636-7864

CPE Program Overview

Program highlights, outlined below, will assist you in understanding the details of the CPE requirement:

- **FUNDING**
 - For 2024, agencies will receive approximately \$500 per full time equivalent (FTE). The FTE count is based on the 2024 annual registration. The annual distribution is subject to appropriation by the legislature.
 - **The CPE funds for 2024 will be released in June.**
 - The 2025 annual distribution of CPE funds will take place in January.
- **CURRICULUM**
 - CPE standards will follow nationally recognized research and development protocols with the goal of determining the most relevant training topics that align with the results of the current Job Task Analysis (JTA), best practices in law enforcement training, and will address contemporary issues in law enforcement.
- **STATUTORY REQUIREMENT**
 - The Commission's annual CPE requirement complies with statute and affects all licensed law enforcement officers in Michigan.
- **TRAINING DELIVERY**
 - Pre-approved synchronous (e.g., live, in real-time, virtual or in-person, etc.) and asynchronous (not live, recorded courses, self-paced, etc.) training sessions that are registered in MITN may satisfy CPE requirements. Only training that is pre-approved and registered with MCOLES will be recognized as qualified training to fulfill the annually required hours.

Mandatory Compliance

Compliance with the Commission's CPE requirement for all Michigan licensed law enforcement officers is a condition of maintaining one's law enforcement license (2023 PA 1, 1965 PA 203, MCL 28.611).

As always, we appreciate your cooperation as we work together to uphold the highest standards of professionalism and integrity in law enforcement. Should you have further questions or concerns, please contact the MSP-MCOLES inbox at MSP-MCOLES@michigan.gov and/or call 517-636-7864.

Best regards,



Timothy S. Bourgeois
Executive Director
Michigan Commission on Law Enforcement Standards

CPE PILOT QUICK REFERENCE GUIDE
2025

2024

2026

Twelve (12) hours of COMMISSION DESIGNATED CPE as outlined below, completed by December 31, 2024.

No less than four (4) hours shall be completed on MCOLES recognized **ETHICS IN POLICING & INTERPERSONAL RELATIONS** training.

Topics include but are not limited to:

- Ethics in Policing
- Laws Pertaining to Civil Rights and Human Relations
- Cultural Competence and Sexual Harassment
- Interpersonal Skills
- Civil Disputes
- Victim Rights
- Procedural Justice

The remaining eight (8) CPE hours shall be completed by all law enforcement officers. However, these 8 hours shall be on any agency selected topic that meets the following three requirements*:

- 1) enhances law enforcement performance, professionalism, public and officer safety, and officer decision making,
- 2) is pre-approved by the law enforcement agency head or their delegate, and
- 3) is pre-approved by MCOLES.

*Refer to the FAQ document for more information.

Suggested training categories include, but are not limited to:

- Legal Updates
- Health and Wellness
- Subject Control
- Emergency Vehicle Operations
- Investigations
- Human Trafficking
- De-escalation

PROJECTED twenty-four (24) hours of COMMISSION DESIGNATED CPE as outlined below, completed by December 31, 2025.

No less than eight (8) hours shall be completed on MCOLES recognized **MENTAL HEALTH CRISIS** training.

Topics include but are not limited to:

- Behavioral Health Emergency Partnership (20 hours)
- Autism Speaks
- Alzheimer's Awareness
- Legal Updates

The remaining sixteen (16) CPE hours shall be completed by all law enforcement officers. However, these 16 hours shall be on any agency selected topic that meets the following three requirements*:

- 1) enhances law enforcement performance, professionalism, public and officer safety, and officer decision making,
- 2) is pre-approved by the law enforcement agency head or their delegate, and
- 3) is pre-approved by MCOLES.

*Refer to the FAQ document for more information.

Suggested training categories include, but are not limited to:

- Subject Control
- Detention and Prosecutions
- Patrol Procedures
- Health and Wellness
- Special Investigations
- Patrol Operations
- Ethics in Policing

PROJECTED twenty-four (24) hours of COMMISSION DESIGNATED CPE as outlined below, completed by December 31, 2026.

No less than eight (8) hour shall be completed on MCOLES recognized **TACTICAL OPERATIONS** training.

Topics include but are not limited to:

- Investigations
- Patrol Procedures
- Legal Updates

The remaining sixteen (16) CPE hours shall be completed by all law enforcement officers. However, these 16 hours shall be on any agency selected topic that meets the following three requirements*:

- 1) enhances law enforcement performance, professionalism, public and officer safety, and officer decision making,
- 2) is pre-approved by the law enforcement agency head or their delegate, and
- 3) is pre-approved by MCOLES.

*Refer to the FAQ document for more information.

Suggested training categories include, but are not limited to:

- Emergency Preparedness/Disaster Control
- Police Skills
- EVO
- Traffic
- Special Investigations

Published DATE: 06/10/2024



SUBJECT: Continuing Professional Education (CPE) for in-service law enforcement officers

PURPOSE: Commission Information

DATE	SECTION	EXECUTIVE DIRECTOR	AUTHOR
April 24, 2024	Career Development	Timothy Bourgeois	Leon Boyer

Background

On January 31, 2023, Public Act 1 of 2023 (hereafter PA 1) appropriated funds to support the implementation of required annual in-service training standards for all licensed law enforcement officers in accordance with rules promulgated under section 11(2) of the MCOLES Act. This section states in part, “The commission may promulgate rules with respect to any of the following: (a) In-service training programs and minimum courses of study and attendance requirements for licensed law enforcement officers.” Prior to January 31, 2023, post academy law enforcement officer training was optional and for practical purposes, individual agencies determined if, and how much, in-service training was required¹. Consequently, licensed officers received differing levels of training.

Issues

PA 1 appropriated funds to support the requirement of licensed law enforcement officers to complete annual in-service training (hereafter referred to as continuing professional education, or CPE). As of this date, the CPE requirement affects approximately 18,400 licensed officers presently employed by approximately 575 Michigan law enforcement agencies. Appropriated funds are to increase Commission staff by adding 7.0 full-time equated positions to support development and implementation of the CPE and establish and implement annual CPE requirements of in-service law enforcement officers. Current staffing and expenditure estimates are outlined in below.

As of April 24, 2024, one CPE Career Development Section Human Resources Developer (HRD) and two Standards Compliance HRD Agency Representatives have onboarded.

The Career Development Section is processing applications for the second HRD. The Licensing and Administrative Services is working to fill one Fiscal Analyst and one General Office Assistant to support CPE. We anticipate filling these two vacancies is spring and summer of 2024.

¹ Exception of the active-duty in-service firearm standard, which includes an educational component as well as a course of fire.

Despite staff deficiencies, CPE planning remains ongoing, and the first distribution of funds (per licensed law enforcement officer) is planned to take place following Commission approval. Distributions will follow each calendar year hereafter.

Internal considerations:

The first and second year will be distributed on per licensed law enforcement officer. Subsequent years may model the law enforcement distribution (LED) funds program.

The Commission is working with Michigan State Police to brand an MCOLES Learning Management System on the Cornerstone platform. The LMS will be managed by the Commission's Career Development Section for CPE.

Internal restrictors:

The Commission will develop CPE policies, procedures, rules, and regulations. The Commission will communicate the CPE standards and requirements to agencies and law enforcement officers and will create an inspection process to ensure standards compliance.

Other considerations under development include the appropriate use of funds, fund reporting, disposition of unspent or misappropriated funds, and potential sanctions.

The MCOLES Information and Tracking Network (MITN) would require development for tracking of distributions and expenditures separate from 1982 PA 302 law enforcement distributions.

External opportunities:

During the initial Pilot CPE, online courses registered in MITN are available to agencies and officers. The Commission staff identified PoliceOne and Virtual Academy as two vendors who are registered in MITN and available for CPE. Additional options/vendors are being explored to help agencies and officers meet CPE requirements.

External challenges:

Commission challenges include non-compliance, whether knowingly or unknowingly, by law enforcement officers, agencies, or vendors, and potential communication roadblocks of the implementation plan.

Non-compliance and the resulting consequences for an agency or individual law enforcement officer shall be established prior to full implementation.

Educating law enforcement agencies on the distinction, reporting, eligibility of expenditures, and commingling of funds from law enforcement distributions would be required.

Recommendations

The Commission staff requests the initiation of funds to agencies begin no later than June 1, 2024, and each calendar year hereafter per licensed law enforcement officer.

The initial three-year CPE cycle will be a *pilot program* with the following guidelines:

The annual CPE requirement is a total of 24 hours. The 24-hour CPE requirement is divided into two segments.

Eight hours of the requirement is comprised of **Commission Designated** training categories and the remaining 16 hours is comprised of **Agency Selected** training categories.

NOTE: For 2024, the CPE requirement has been reduced to a total of 12 training hours (4 hours of Commission designated training categories and 8 hours of agency selected training categories). The reduced number of training hours required for 2024 is based on implementing the mandatory CPE requirements halfway through the 2024 calendar year.

2024 COMMISSION DESIGNATED CPE: No less than 4 hours of training shall be completed in Cultural Competence, to include one or more of the following training categories:

- Diversity, Equity, and Inclusion
- De-Escalation
- Human Trafficking
- Ethics in Policing

2024 AGENCY SELECTED CPE: No less than 8 hours of training shall be completed. Suggested training categories include, but are not limited to:

- Legal Update
- Health and Wellness
- Subject Control
- Emergency Vehicle Operations
- Investigations
- Local Agency Needs

Any equipment must be necessary to meet CPE requirements and will require a justification statement adhering to MCOLES guidelines, not less than 2 estimates, and be subject to audit.

Future Considerations

The in-service CPE ensures that Commission licensed law enforcement officers maintain a level of proficiency and professionalism throughout their career to appropriately serve the people of Michigan. As such, the Commission will continue to support educational requirements by developing subsequent cycles for all licensed law enforcement officers.

The CPE standards will continue following nationally recognized research and development protocols with the goal of determining the most relevant educational and training topics that align with the results of the current JTA, industry standards, and contemporary issues in law enforcement.

Individual agencies will maintain their ability to conduct their own in-house CPE² of MCOLES registered topics and courses to comply with CPE requirements. The Commission's Career Development Section will review the curriculum and courseware³ to ensure the agency CPE complies with established standards and objectives.

² All CPE mandated courses must be MCOLES registered in MITN.

³ At the Commission's discretion.



240280

PROPOSAL# 21000572

RESOLUTION NO.: _____

PRESENTED: 7-17-2024

ADOPTED: _____

BY THE CITY ADMINISTRATOR:

RESOLUTION TO SORENSEN GROSS FOR DORT PUMP REHABILITATION CHANGE ORDER #4

WHEREAS, The Division of Purchases and Supplies solicited proposals for the rehabilitation of the Dort Pump Station, a project for the Water System Infrastructure Improvements for the Nation (WIIN) and Sorensen Gross, 3407 Torrey Road, Flint, MI, was the lowest bidder from twenty (20) solicitations for said requirements

WHEREAS, Flint City Council approved Resolution #210103 to enter into a contract with Sorensen Gross on March 25, 2021, in an amount not to exceed \$3,649,397.00

WHEREAS, Flint City Council approved Resolution #210580 Change Order #1 on January 10,2022, in the amount of \$420,247.47 for a total contract amount not to exceed \$4,069,994.47

WHEREAS, Flint City Council approved Resolution #224036 Change Order #2 on August 22, 2022, in the amount of \$299,255.00 for a total contract amount not to exceed \$4,369,169.47

WHEREAS, Flint City Council approved Resolution #230302 Change Order #3 on September 23, 2022, in the amount of \$30,222.20 for a total contract amount not to exceed \$4,339,391.47

WHEREAS, The Dort Pump Rehabilitation project is complete. The Water Plant is requesting additional funding for Change Order #4 for final billing. There were additional services required which include: rewiring of unity heaters, start up and callout for pump #2 for overages from final billing, additional painting of new steel bearing supports on pumps #3 and #4, overages for PLC programming allowance on services from MAK Controls, and agreed upon coverage for additional support steel platforms for pumps #3 and #4, in an amount not to exceed \$51,880.50, for a total revised contract amount of \$4,451,271.97.

GL/ACCOUNT#	ACCOUNT NAME/GRANT CODE	AMOUNT REQUESTED
496-536-802.802.076	Dort Pump/FEPA18WIIN-1	\$51,880.50
	FY2025 TOTAL	\$51,880.50

BE IT RESOLVED, that the Proper City Officials, upon Flint City Council's approval, are hereby authorized to enter into change order #4 contract with Sorensen Gross for the Dort Pump Station Rehabilitation Project, in an amount not to exceed \$51,880.50 for FY25 (07/01/24-06/30/25) for an aggregate grand total amount not to exceed \$4,451,271.97.

APPROVED AS TO FORM:

William Kim
William Kim (Jul 3, 2024 07:48 EDT)
William Kim, Chief Legal Officer

APPROVED AS TO FINANCE:

Phillip Moore
Phillip Moore (Jul 3, 2024 07:40 EDT)
Philip Moore, Chief Financial Officer

FOR THE CITY OF FLINT:

CLYDE D EDWARDS / A0239
CLYDE D EDWARDS / A0239 (Jul 3, 2024 10:56 EDT)
Clyde Edwards, City Administrator

APPROVED AS TO PURCHASING:

Lauren Rowley
Lauren Rowley, Purchasing Manager

APPROVED BY CITY COUNCIL:

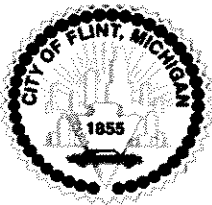

CITY OF FLINT STAFF REVIEW FORM

TODAY'S DATE: June 25, 2024

BID/PROPOSAL#

AGENDA ITEM TITLE: Resolution Authorizing Appropriate City Officials to Enter Into Change Order #4 Contract with Sorensen Gross for the Dort Pump Station Rehabilitation Project

PREPARED BY: Yolanda Gray - Department of Public Works & Utilities

VENDOR NAME: Sorensen Gross

BACKGROUND/SUMMARY OF PROPOSED ACTION:

Flint City Council approved Resolution #210103 to enter into a contract with Sorensen Gross the lowest bidder from twenty (20) solicitations, on March 25, 2021, in an amount not to exceed \$3,649,397.00 for the Dort Pump Station Rehabilitation project with funding coming from the Water System Infrastructure Improvements for the Nation (WIIN). The City of Flint Water Plant is requesting to enter into change order #4 for additional funds which will close out the completion of the rehabilitation project. The additional services include: rewiring of unity heaters, start up and callout for pump #2 for overages from final billing, additional painting of new steel bearing supports on pumps #3 and #4, overages for PLC programming allowance on services from MAK Controls, and agreed upon coverage for additional support steel platforms for pumps #3 and #4, in an amount not to exceed \$51,880.50 for a revised total contract amount of \$4,451,271.97

PREVIOUS ALLOCATIONS (INCLUDE ALL ACCOUNTS USED FOR THIS PURPOSE)/ PROVIDE RESOLUTION OR CONTRACT INFORMATION THAT APPLIES

Change Order #1 \$420,547.47 Account 496-536.802-802.076
Change Order #2 \$299,225.00 Account 496-536.802-802.076
Change Order #3 \$30,222.00 Account 496-536.802-802.076

POSSIBLE BENEFIT TO THE CITY OF FLINT (RESIDENTS AND/OR CITY OPERATIONS) INCLUDE PARTNERSHIPS AND COLLABORATIONS:

The pumps haven't been updated since 1992. The rehabilitation allows the pumps to be properly sized for energy efficiency as well as completing the required improvements as noted in the EGLE Administrative Consent Order (ACO) 3.2 Dort Reservoir and Booster Pumping Station (Pump Station 4)

FINANCIAL IMPLICATIONS:



CITY OF FLINT STAFF REVIEW FORM

Funding available from Water System Infrastructure Improvements for the Nation (WIIN)

BUDGETED EXPENDITURE? YES NO IF NO, PLEASE EXPLAIN:

Dept.	Name of Account	Account Number	Grant Code	Amount
	Sorensen Gross - Dort Pump	496-536.802-802.076	FEPA18-WIIN	\$51,880.50
FY25 GRAND TOTAL				\$51,880.50

PRE-ENCUMBERED? YES NO REQUISITION NO: 250008944

ACCOUNTING APPROVAL:

Yolanda Gray

Date:

6-28-24

WILL YOUR DEPARTMENT NEED A CONTRACT? YES NO Existing Contract

WHEN APPLICABLE, IF MORE THAN ONE (1) YEAR, PLEASE ESTIMATE TOTAL AMOUNT FOR EACH BUDGET YEAR: *(This will depend on the term of the bid proposal)*

BUDGET YEAR 1

BUDGET YEAR 2

BUDGET YEAR 3

OTHER IMPLICATIONS *(i.e., collective bargaining)*:

STAFF RECOMMENDATION: *(PLEASE SELECT)*: APPROVED NOT APPROVED

DEPARTMENT HEAD SIGNATURE:

Scott Deengee *6-28-24*
(Name, Title)



CITY OF FLINT

210103

PROPOSAL #21000572

RESOLUTION NO: _____

PRESENTED: MAR - 3 2021

ADOPTED: MAR 15 2021

BY THE CITY ADMINISTRATOR:

RESOLUTION TO SORENSEN GROSS COMPANY FOR THE DORT PUMP STATION REHABILITATION

The Finance Department - Division of Purchases and Supplies solicited proposals for the Dort Pump Station Rehabilitation, a project for the Water System Infrastructure Improvements for the Nation (WIIN); and

Sorensen Gross Company, 3407 Torrey Road, Flint, Michigan 48507, was the low bidder from twenty (20) solicitations for said requirements based on highest score and lowest price.

Funding for said services are available in the following account for FY21 (07/01/20 - 06/30/21):

Account Number	Account Name	Amount
496-552.000-801.076 FEPA18WIIN1	Dort Pumping Station	\$ 3,649,397.00
FY21 (07/01/20 - 06/30/21) Total		\$ 3,649,397.00

IT IS RESOLVED that the appropriate City officials are authorized to do all things necessary to issue a contract to Sorensen Gross Company for Dort Pump Station Rehabilitation in the amount not to exceed for FY21 (07/01/20 - 06/30/21) \$3,649,397.00.

APPROVED AS TO FORM:

Angela Wheeler, Chief Legal Officer

APPROVED AS TO FINANCE:

Amanda Trujillo, Acting Chief Financial Officer

FOR THE CITY OF FLINT:

Clyde Edwards, City Administrator

APPROVED BY CITY COUNCIL:

Kate Fields, City Council President

APPROVED AS TO PURCHASING:

Joyce A. McClane, Purchasing Manager



RESOLUTION NO.: 210580
 PRESENTED: DEC - 8 2021
 ADOPTED: JAN 10 2022

PROPOSAL# 21-572

BY THE CITY ADMINISTRATOR:

RESOLUTION TO SORENSON GROSS FOR CHANGE ORDER #1 FOR DORT PUMP STATION REHABILITATION

On March 3, 2021, Flint City Council approved Resolution #210103 to enter into an agreement with Sorenson Gross to complete rehabilitation work on the Dort Pump Station at the Water Treatment Plant in an amount not-to-exceed \$3,649,897.00.

Whereas, completion of the work at the Dort Pump Station is requiring additional services to the rehabilitation project including secondary water interconnect, isolate pumps, sandblasting and repainting, electrical materials, reinforcing steel material and masonry repairs at an additional cost of \$420,547.47.

Whereas, the Water Treatment Plant is requesting an authorization to enter into Change Order #1 with Sorenson Gross, 2407 Torrey Rd., Flint, MI., 48507 to come from the following WNN account:

Account Number	Account Name	Grant Code	Amount
496-552.000-801.076	Dort -Cedar Pump Station	FEP18WNN-1	\$420,547.47
		FY22 GRAND TOTAL	\$420,547.47

IT IS RESOLVED, that the Appropriate City Officials are to do all things necessary to enter into Change Order #1 with Sorenson Gross for the Dort Pump Station Rehabilitation project, in a Change Order amount for additional services not-to-exceed \$420,547.47, with a total contract amount not-to-exceed \$4,069,944.47 for FY22 (07/01/21-06/30/22).

APPROVED AS TO FORM:
Angela Wheeler
Angela Wheeler - Title 29, Part 53-20 (15)
 Angela Wheeler, Chief Legal Officer

APPROVED AS TO FINANCE:
Robert J.F. Widigan
Robert J.F. Widigan Title 29, 202110 40 (15)
 Robert J.F. Widigan, Chief Financial Officer

FOR THE CITY OF FLINT:
Clyde D. Edwards
Clyde D. Edwards 01/27/2021 16:24 (11)
 Clyde Edwards, City Administrator

APPROVED BY CITY COUNCIL:
Eric Mays
 Eric Mays, City Council President

APPROVED AS TO PURCHASING:
Lauren Rowley
 Lauren Rowley
 Purchasing Manager



RESOLUTION NO.: 220346
 PRESENTED: AUG 17 2022
 ADOPTED: AUG 22 2022

PROPOSAL# 21000572

BY THE CITY ADMINISTRATOR:

**RESOLUTION TO SORENSON GROSS FOR DORT PUMP STATION REHABILITATION,
 CHANGE ORDER #2**

WHEREAS, The Division of Purchases and Supplies solicited proposals for the rehabilitation of the Dort Pump Station, a project for the Water System Infrastructure Improvements for the Nation (WIIN) and Sorenson Gross, 3407 Torrey Road Flint, MI was the low bidder from (20) solicitations for said requirements based on highest score and lowest price.

WHEREAS, Flint City Council approved the issuance of the contract with Sorenson Gross for this project via Resolution #210103 on March 15, 2021 for an amount not-to-exceed \$3,649,397.00.

WHEREAS, Flint City Council approved Change Order #1 to Sorenson Gross for this Project via Resolution #210580 On January 10, 2022 for an amount not-to-exceed \$420,547.47.

WHEREAS, The Water Plant is requesting additional funding for Change Order #2, as it was discovered during additional services, a replacement of the discharged header within the northern dry well for pumps (1) and (2) is required. The total cost of this Change Order #2 is not-to-exceed \$299,225.00, for a total contract price for this project not-to-exceed \$4,369,169.47.

Funding will come from the following account(s):

Account Number	Account Name/Grant Code	Amount
496-536.802-802-076	Dort Pump Station FEPA18WIIN-1	\$ 299,225.00
	FY23 GRAND TOTAL	\$299,225.00

IT IS RESOLVED, That the Appropriate City Officials are hereby authorized to enter into Change Order #2 of the Contract with Sorenson Gross Construction for the Dort Pump Station Rehabilitation Project, in an amount not-to-exceed \$299,225.00 for FY23 (07/01/22-06/30/23), for an aggregate grand total amount not-to-exceed \$4,369,169.47.

APPROVED AS TO FORM:

William Kim
William Kim Aug 20 2022 11:17 EDT

William Kim, City Attorney

APPROVED AS TO FINANCE:

Robert J.F. Widigan
Robert J.F. Widigan Aug 19 2022 11:14 EDT

Robert J.F. Widigan, Chief Financial Officer

FOR THE CITY OF FLINT:

Clyde D. Edwards
Clyde D. Edwards Aug 20 2022 14:43 EDT

Clyde Edwards, City Administrator

APPROVED BY CITY COUNCIL:

APPROVED BY
 CITY COUNCIL

 AUG 22 2022

APPROVED AS TO PURCHASING:

Lauren Rowley

Lauren Rowley, Purchasing Manager

230302



RESOLUTION NO.: _____

PRESENTED: SEP - 6 2023

ADOPTED: SEP 25 2023

**BY THE CITY ADMINISTRATOR
RESOLUTION TO SORENSEN GROSS FOR CHANGE ORDER #3 FOR DORT PUMP
STATION REHABILITATION**

WHEREAS, The Division of Purchases and Supplies solicited proposals for the rehabilitation of the Dort Pump Station, a project for the Water System Infrastructure Improvements for the Nation (WIIN) and Sorensen Gross, 3407 Torrey Road, Flint, MI, was the lowest bidder from twenty (20) solicitations for said requirements

WHEREAS, Flint City Council approved Resolution #210103 to enter into a contract with Sorensen Gross on March 25, 2021, in an amount not to exceed \$3,649,397.00

WHEREAS, Flint City Council approved Resolution #210580 Change Order #1 on January 10, 2022, in the amount of \$420,547.47 for a total contract amount not to exceed \$4,069,944.47.

WHEREAS, Flint City Council approved Resolution #220346 Change Order #2 on August 22, 2022, in the amount of \$299,225.00 for a total contract amount not to exceed \$4,369,169.47.

WHEREAS, The Water Plant is requesting additional funding for Change Order #3, as it was discovered during inspection, vibration coming from the flow meter. The following services are required to complete the project: disconnect and reconnect electrical to roof exhaust fans, sandblast and paint existing steel lids, yellow striping at the motor base, an ultrasonic clamp on the flow meter, and survey for the flow meter. The total cost of Change Order #3 is not to exceed \$30,222.00, for a total contract price not to exceed \$4,399,391.47.

GL/ACCOUNT #	ACCOUNT NAME /GRANT CODE	AMOUNT REQUESTED
496-536.802-802.076	Dort Pump Station/FEPA18WIIN-1	\$30,222.00
	FY2024 TOTAL	\$30,222.00

IT IS RESOLVED that the Appropriate City Officials are hereby authorized to enter into Change Order #3 of the contract with Sorensen Gross for the Dort Pump Rehabilitation Project, in an amount not to exceed \$30,222.00 for FY24(07 01 23-06 30 24) for an aggregate grand total amount not to exceed \$4,399,391.47

APPROVED AS TO FORM:

William Kim, City Attorney

APPROVED AS TO FINANCE:

Jane Mager, Acting Chief Financial Officer

FOR THE CITY OF FLINT:

Clyde Edwards, City Administrator

APPROVED BY CITY COUNCIL:

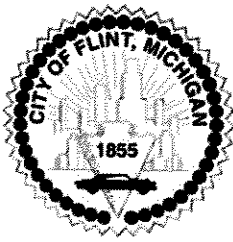

RESOLUTION NO.: 240282
 PRESENTED: 7-17-2024
 ADOPTED: _____

BY THE CITY ADMINISTRATOR:

RESOLUTION TO DEERE CREDIT, INC. FOR EQUIPMENT LEASES

WHEREAS, The Fleet Services Division leases heavy equipment as part of the fleet maintenance & replacement program; the Fleet Services Division currently has two (2) pieces of heavy equipment requiring lease payment to Deere Credit for FY25 - one being a Backhoe utilized by Water Pollution Control and one being a Front-End Loader utilized by Street Maintenance.

WHEREAS, the Fleet Services Division is recommending these annual lease payments for Deere Credit to be paid in an FY25 amount of \$76,759.25.

Funding is to come from the following account(s):

Account Number	Account Name/ Grant Code	Amount
661-229.000-940.000	RENTALS	\$76,759.25
	FY2025 TOTAL	\$76,759.25

IT IS RESOLVED, that the Division of Purchases & Supplies is hereby authorized to issue a Purchase Order to Deere Credit, Inc. for Fleet leased heavy equipment during FY25 (07/01/24 – 06/30/25) in an amount not to exceed \$76,759.25.

APPROVED AS TO FORM:

 William Kim (Jul 5, 2024 08:02 EDT)

William Kim, City Attorney

APPROVED AS TO FINANCE:

 Phillip Moore (Jul 5, 2024 07:37 EDT)

Phillip Moore, Chief Financial Officer

FOR THE CITY OF FLINT:

CLYDE D EDWARDS / A0245
 CLYDE D EDWARDS / A0245 (Jul 8, 2024 11:38 EDT)

Clyde Edwards, City Administrator

APPROVED BY CITY COUNCIL:

APPROVED AS TO PURCHASING:



Lauren Rowley, Purchasing Manager



CITY OF FLINT STAFF REVIEW FORM

TODAY'S DATE: 7/2/2024

BID/PROPOSAL#

AGENDA ITEM TITLE: *Lease Payments for Heavy Equipment*

PREPARED BY: *Christine Tagg, Fleet Services*

VENDOR NAME: *Deere Credit, Inc*

BACKGROUND/SUMMARY OF PROPOSED ACTION:

Fleet Services is requesting a purchase order be issued for FY25 in the amount of \$76,759.25 to make multiple lease payments during FY25 for two (2) pieces of heavy equipment being used by Water Pollution Control and Street Maintenance. Final payment - 5 of 5 - for Unit 6092 and final payments - 4 of 5 and 5 of 5 - for Unit 7910 (payment 4 of 5 scheduled for FY24 but not paid to due late receipt of invoice).

PREVIOUS ALLOCATIONS (INCLUDE ALL ACCOUNTS USED FOR THIS PURPOSE)/ PROVIDE RESOLUTION OR CONTRACT INFORMATION THAT APPLIES

GL 661-229.000-940.000
Resolutions 230262, 210362, 190027
Unit 6092 – 5 Lease Payments of \$18,506.41 + Property Tax
Unit 7910 – 5 Lease Payments of \$26,442.59 + Property Tax

POSSIBLE BENEFIT TO THE CITY OF FLINT (RESIDENTS AND/OR CITY OPERATIONS) INCLUDE PARTNERSHIPS AND COLLABORATIONS:

This equipment enables the Street Maintenance department to perform work on roadways, sidewalks and other areas as needed for the safety and convenience of City residents and businesses.



CITY OF FLINT STAFF REVIEW FORM

FINANCIAL IMPLICATIONS:

NTE \$76,759.25 in FY25, GL 661-229.000-940.000

BUDGETED EXPENDITURE? YES NO IF NO, PLEASE EXPLAIN:

Dept.	Name of Account	Account Number	Grant Code	Amount
3331	Rentals	661-229.000-940.000		\$76,759.25
FY25 GRAND TOTAL				\$76,759.25

PRE-ENCUMBERED? YES NO REQUISITION NO: 250008757

ACCOUNTING APPROVAL: Christine Tagg
Christine Tagg (Jul 2, 2024 05:15 EDT) Date: 7/2/2024

WILL YOUR DEPARTMENT NEED A CONTRACT? YES NO

WHEN APPLICABLE, IF MORE THAN ONE (1) YEAR, PLEASE ESTIMATE TOTAL AMOUNT FOR EACH BUDGET YEAR: *(This will depend on the term of the bid proposal)*

BUDGET YEAR 1 \$

BUDGET YEAR 2

BUDGET YEAR 3

OTHER IMPLICATIONS *(i.e., collective bargaining)*:

STAFF RECOMMENDATION: *(PLEASE SELECT)*: APPROVED NOT APPROVED

DEPARTMENT HEAD SIGNATURE: Marquita Blair
Marquita Blair (Jul 2, 2024 09:20 EDT)
(Marquita Blair, Fleet Administrator)



230262

RESOLUTION NO.: _____

AUG - 9 2023

PRESENTED: _____

AUG 14 2023

ADOPTED: _____

BY THE CITY ADMINISTRATOR:

RESOLUTION TO DEERE CREDIT, INC. FOR EQUIPMENT LEASES

WHEREAS, The Fleet Services Division leases heavy equipment as part of the fleet maintenance & replacement program; the Fleet Services Division currently has four (4) pieces of heavy equipment requiring lease payment to Deere Credit for FY24; said equipment being utilized by Water and Sewer Distribution, Water Pollution Control, and Streets Maintenance divisions.

WHEREAS, the Fleet Services Division is recommending these annual lease payments for Deere Credit to be paid in an FY24 amount of \$118,687.48.

Funding is to come from the following account(s):

Account Number	Account Name/ Grant Code	Amount
661-229.000-940.000	RENTALS	\$118,687.48
	FY2023 TOTAL	\$118,687.48

IT IS RESOLVED, that the Division of Purchases & Supplies is hereby authorized to issue a Purchase Order to Deere Credit, Inc. for Fleet leased heavy equipment during FY24 (07/01/23 – 06/30/24) in an amount not to exceed \$118,687.48.

APPROVED AS TO FORM:

William Kim (Jul 18, 2023 09:48 EDT)

William Kim, City Attorney

APPROVED AS TO FINANCE:

Jane Mager (Jul 18, 2023 10:23 EDT)

Jane Mager, Acting Chief Financial Officer

FOR THE CITY OF FLINT:



CLYDE D. EDWARDS
CLYDE D. EDWARDS (Jul 18, 2023 12:14 EDT)

Clyde Edwards, City Administrator

APPROVED BY CITY COUNCIL:

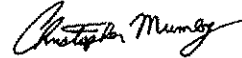

APPROVED AS TO PURCHASING:



Christopher Mumby, Interim Purchasing Manager



Customer Purchase Order for John Deere Construction and Forestry Products - USA

JOHN DEERE

PURCHASER NAME AND ADDRESS (First Signer)			
NAME (First, Middle, Last)			
City of Flint			
STREET or RR 702 W. 12th Street			
CITY Flint	STATE MI	ZIP CODE 48502	COUNTY Genesee
PHONE NUMBER		EMAIL ADDRESS	
PURCHASER NAME AND ADDRESS (Second Signer)			
NAME (First, Middle, Last)			
STREET or RR			
CITY	STATE	ZIP CODE	COUNTY
PHONE NUMBER		EMAIL ADDRESS	

DEALER NAME AND ADDRESS			
DEALER NAME AIS Construction Equipment Corp.			Dealer Account No.: 17-8022
STREET or RR 56555 Pontiac Trail			
CITY New Hudson	STATE MI	ZIP CODE 48165	Date of Order: 3/31/2020
Dealer Order No.:		TYPE OF SALE: LEASE	
PURCHASER TYPE: 5 City/Town/Village		MARKET USE CODE:	
Add purchaser to Mailing List (Check One or More)			
<input type="checkbox"/> Construction <input type="checkbox"/> Utility <input type="checkbox"/> Forestry <input checked="" type="checkbox"/> Government			
PURCHASER IS: <input checked="" type="checkbox"/> Business <input type="checkbox"/> Individual		Purchaser Acct.: 53715	
<input type="checkbox"/> SOCIAL SECURITY <input type="checkbox"/> IRS TAX ID NO <input type="checkbox"/> EIN			
NO.:			

EXTENDED WARRANTY IS: <input type="checkbox"/> Accepted <input checked="" type="checkbox"/> Rejected _____ (Initials)	LOCATION OF FIRST WORKING USE: County Genesee City Flint	STATE MI	COUNTY CODE 049
--	---	-------------	--------------------

Ultimate Uptime Package Purchased:		<input type="checkbox"/> Yes <input type="checkbox"/> No _____ Initials						
QTY	NEW	DEMO	RENT	USED	EQUIPMENT (Model, Size, Description)	Hours of Use	PIN or Serial Number	Delivered Cash Price
1	<input checked="" type="checkbox"/>	<input type="checkbox"/>	<input type="checkbox"/>	<input type="checkbox"/>	544L Wheel Loader	5	1DW544LHCLF706957	\$177,849.00
					As per quote dated 1/14/2020			
					On 5 Year Governmental Operating Lease			
					w/ 5 Annual Payments of \$26,442.59 Each			
(1) TOTAL CASH PRICE								\$177,849.00

QTY	TRADE-IN (Model, Size, Description)	Hours of Use	PIN OR SERIAL NUMBER	AMOUNT
				(2) TOTAL TRADE-IN ALLOWANCE
				(3) BALANCE (1-2) \$177,849.00
				(4) SALES TAX RATE _____ % \$0.00
				(5) ADDITIONAL FEES
				(6) SUBTOTAL (3 & 4 & 5) \$177,849.00
				(7) RENTAL APPLIED
				(8) CASH WITH ORDER
				(9) BALANCE DUE (6-(7 & 8)) \$177,849.00

ACKNOWLEDGMENTS: Purchaser offers to sell, transfer, and convey the item(s) listed as "Trade In" to the Dealer at or prior to the time of delivery of the above product(s), as a "trade-in" to be applied against the cash price. Purchaser represents that each "trade-in" item shall be free and clear of all security interests, liens, and encumbrances at the time of transfer to the Dealer except to the extent shown below. The price to be allowed for each "trade-in" item is listed on this document. The Purchaser promises to pay the balance due (line 9) shown hereon in cash, or to execute a Time Sale Agreement (Retail Installment Contract), or a Loan Agreement for the purchase price of the Product(s), plus additional charges shown thereon, or to execute a Lease Agreement, on or before delivery of the equipment ordered herein. Despite delivery of the Product(s) to the Purchaser, title shall remain with the Seller until one of the foregoing is accomplished. The Purchaser and the Dealer agree that this Purchase Order is not a security agreement and that delivery of the Product(s) to the Purchaser pursuant to this Purchase Order will not constitute possession of the Product(s) by the Purchaser, as a debtor, for the purposes of the purchase money security provisions in any statutes relating to personal property security or its equivalent. Purchaser understands that its rights in connection with this purchase are limited as set forth in this Purchase Order.

DISCLOSURE OF REGULATION APPLICABILITY: When operated in California, any off-road diesel vehicle may be subject to the California Air Resources Board In-Use Off-Road Diesel Vehicle Regulation. It therefore could be subject to retrofit or accelerated turnover requirements to reduce emissions of air pollutants. More information is available on the California Air Resources Board website at <http://www.arb.ca.gov/mapproofordiesel/ordiesel.htm>.

IMPORTANT WARRANTY NOTICE: The Standard Warranty for new John Deere construction and forestry products is set forth in a separate document provided by the dealer. Please read the Standard Warranty carefully before signing. No express warranty is made unless specified in the Warranty Statement. PURCHASER'S RIGHTS AND REMEDIES PERTAINING TO THIS PURCHASE ARE LIMITED AS INDICATED IN THE STANDARD WARRANTY AND PURCHASE ORDER. WHERE PERMITTED BY LAW, NO IMPLIED WARRANTY OF MERCHANTABILITY, CONDITIONS OR FITNESS IS MADE.

TERMS & CONDITIONS VERIFICATION STATEMENT

Use of John Deere Data Services ("Services"), if applicable, and all rights and obligations of John Deere and the Purchaser (or "Customer" as identified in the applicable agreement), are governed by the terms and conditions outlined in the Warranty Statement and the applicable John Deere Construction & Forestry Company Subscriptions & Data Services Dealer Agreement and/or Customer Data Services agreements available at www.johndeere.com/Agreements. Purchaser agrees to be bound by these terms and conditions if Purchaser activates or otherwise uses any of the Data Services. If Purchaser does not agree to these terms and conditions, Purchaser must not activate or otherwise use the Data Services.

The undersigned purchaser(s) (the "Purchaser") hereby orders the product(s) (the "Product") described above from the Dealer. The Dealer shall not be liable for failure to provide the Product or for any delay in delivery if such failure or delay is due to the Dealer's inability to obtain such Product from the manufacturer or supplier or other cause beyond the Dealer's control. The cash price shown above is subject to the Dealer receiving the Product from the manufacturer or supplier prior to any change in price by the manufacturer or supplier and is also subject to any new or increased taxes being imposed upon the sale of the Product after the date of this Purchase Order.

Purchaser's signature below acknowledges the Purchaser has received a copy of the Standard Warranty, Version _____ (Initials) _____ and understands its terms and conditions.

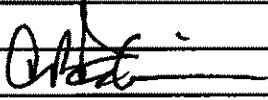
Purchaser (First Signer) City of Flint Signature _____ Date 3/31/2020
Purchaser (Second Signer) _____ Signature _____ Date _____
Dealer Representative _____ Signature  Date _____
Salesperson Chris Robinson Signature _____ Date 3/31/2020

DELIVERY ACKNOWLEDGEMENT	Delivered with Operator's Manual On: 7/7/2020	Purchaser Signature:
--------------------------	--	----------------------

STANDARD WARRANTY FOR NEW JOHN DEERE CONSTRUCTION, UTILITY, CCE AND FORESTRY PRODUCTS – US & Canada

- **Construction, Forestry & Compact Construction Equipment (CCE) Products***: 12 months Full Machine Standard Warranty
- *** Compact Construction Equipment Products** Delivered and settled on or after 01 June 2018: 24 months or 2000 hours (whichever comes first) Full Machine Standard Warranty
- **C&E Series Pull-Type Scrapers**: 6 months Full Machine Standard Warranty
- **DC & DE Series Pull-Type Scrapers**: 12 months Full Machine Standard Warranty
- **Scraper Tractors**: 24 Months or 2000 Hours (whichever occurs first) Full Machine Standard Warranty
- **Forestry Attachments**: 12 Months or 2000 Hours (whichever occurs first) Full Machine Standard Warranty
- **Frontier Equipment**: 6 months Full Machine Standard Warranty (90 days in rental applications)

The "Standard Warranty" is part of the warranty protection package available from John Deere Construction & Forestry Company (John Deere Limited in Canada) ("John Deere") to purchasers of new John Deere products ("product"):

STANDARD Warranty is John Deere's standard new product warranty, described in this document, provided at no additional charge to the purchaser.

EXTENDED Warranty is a separate repair contract made available by John Deere for purchasers who wish to complement their Standard Warranty coverage. Complete Extended Warranty details, including coverage options and limitations, are set forth in the Application for Extended Warranty, which is available from authorized John Deere dealers.

STRUCTURAL Warranty applies to certain structural components as listed below and as described in this document.

FACTORY-INSTALLED UNDERCARRIAGE Warranty applies to certain undercarriage components as listed below and as described in this document.

A. STANDARD WARRANTY - GENERAL PROVISIONS

John Deere will repair or replace, at its option, any parts (except those specified below) of a new John Deere product that, as delivered to the original retail purchaser(s), are defective in material or workmanship. Performance of this warranty will be free of charge for parts and labor/labour, except as otherwise stated below. Standard Warranty applies only to purchases from John Deere and authorized John Deere dealers and, except as otherwise provided in the next sentence and section L below, is extended only to the original retail purchaser of the product. Remaining Standard Warranty applicable to a used John Deere product is transferred to a subsequent purchaser of the product only if the subsequent purchaser requests a transfer from an authorized John Deere dealer before the product's Standard Warranty expires. Coverage begins on the date of delivery of the product to the original retail purchaser. For purposes of this warranty, a product that has been rented, used for demonstration purposes for 150 or more hours, or otherwise used prior to its original retail purchase has been "used" for the total duration of such use. Warranty statements required by law covering engine emissions-related parts and components are found on a separate written warranty certificate provided to the purchaser at the time of the original retail purchase.

B. WHAT IS COVERED BY STANDARD WARRANTY -

All parts of a new John Deere product (except those noted in Sections D and E below) are covered during the Standard Warranty period set out above.

C. EXCLUSIVE REMEDY -

The repair or replacement of covered parts or components that are defective, as provided in Sections A, B, D.2 and D.3 herein, shall be the purchaser's exclusive remedy for any defect in the product. However, if after repeated attempts such repair or replacement fails to correct the performance problem caused by the defect, the purchaser's sole remedy shall be a refund of the amount paid for the product (in exchange for a return of the product), excluding any transportation charges, license fees, taxes and insurance premiums, and less a reasonable allowance for use of the product prior to its return. In no event will the dealer, John Deere or any company affiliated with John Deere be liable for any incidental or consequential damages, including but not limited to loss of profits, rental of substitute equipment or other commercial loss. Correction of defects in the manner provided above shall constitute fulfillment of all liabilities of the Dealer, John Deere, or any company affiliated with John Deere to the purchaser or any other

person, whether based upon contract, tort, strict liability, or otherwise. This limitation does not apply to claims for personal injury.

D. ITEMS COVERED SEPARATELY -

1. Standard Warranty does not apply to batteries, radios, tires, cameras, or to Cummins, MTU or Detroit Diesel Engines installed in John Deere products, which are covered by separate written warranties.
2. Factory-Installed Undercarriage Warranty covers all non-rubberized factory-installed undercarriage wear components for 3 years or 4,000 hours from the date of delivery to the original retail purchaser, whichever occurs first (unless terminated earlier under Section F, below). For purposes of this warranty, a product that has been rented, used for demonstration purposes for 150 or more hours, or otherwise used prior to its original retail purchase has been "used" for the total duration of such use. In addition to the items listed in section E below, Factory-Installed Undercarriage Warranty does not cover: failures due to wear, machine application, maintenance practices, or improper machine configuration; removal and installation labor/labour; transportation or hauling costs; unapproved parts; non-wear items; and rubberized undercarriage components such as rubber tracks. Warranty claims will be pro-rated based upon wear of the failed component and whether track shoe width is approved by John Deere. Factory-Installed Undercarriage Warranty does not apply to Scraper Tractors.
3. StructurALL Warranty for new John Deere Products (except Compact Excavators & Loaders, Skid-Steer Loaders, Compact Track Loaders, Scraper Tractors, Pull-Type Scrapers, and Forestry Attachments, which are not eligible for StructurALL Warranty) begins at the date of delivery to the original retail purchaser and ends (unless terminated earlier under Section F, below) after three (3) years, or 10,000 hours (whichever occurs first). For purposes of this warranty, a product that has been rented, used for demonstration purposes for 150 or more hours, or otherwise used prior to its original retail purchase has been "used" for the total duration of such use. **StructurALL Warranty applies only to the following structural components listed below as installed on the product at the time of original manufacture.** If a particular component is not listed below it is not covered by StructurALL Warranty.

Arm; Articulation Joint (incl. pins & bushings); Bin Frame; Boom; Carbody; C-Frame*; Circle Frame; Coupler (John Deere built ONLY); Dipperstick; Draft Frame; Engine Frame; Equipment Frame; Grapple Arch and Grapple Boom; Loader Arm; Loader Frame; Mainframe; Moldboard Lift Arm; NeverGrease™ Pin Joints [Includes steering pin and bushing joints (standard equipment), roller elements (roller bearings) in bucket to boom joints and sliding elements (bushing) for boom and linkage joints (optional equipment)]; Rollover Protection Structure (ROPS); Side Frame; Swing Frame; Track Frame; Undercarriage Frame; X-Frame; Z-bar loader linkage (including bell crank and bucket driver link); Specialty booms and arms marketed as "heavy duty" by John Deere.

Items Covered by StructurALL for Cut-to-Length Forestry Machines: Front frame (welded assembly); Rear frame (welded assembly); Crane king post with basement; Middle joint frame; Cabin swing frame; Main Boom

StructurALL Warranty does not apply to:

1. Any product used primarily in extreme duty or severe duty applications such as but not limited to: demolition and wrecking, chemical plant (including fertilizer plants), salt mines, steel mill, land fill and transfer stations, scrap handling, scarifying and other applications that are similarly destructive or similarly heavy duty except specialty booms and arms as stated in Section D.3 above.
2. C-Frames on H-Series & J-Series Crawlers equipped with root rakes or used in forestry applications unless equipped with an "extreme duty" reinforcement package.
3. Cut-to-Length Forestry Heads and Slash Bundler Units.
4. Crawlers equipped with optional side booms.
5. Cut-to-Length Forestry, Excavator, and Log Loader swing bearings.
6. Motor Graders equipped with front- or rear-mounted snow wings.

E. ITEMS NOT COVERED -

John Deere is NOT responsible for the following:

1. Freight
2. Adjustments to compensate for wear, for periodic maintenance or adjustments that result from normal wear and tear.
3. Damage caused by unapproved adjustments (electronic or mechanical) to machine or machine components outside of published specifications including but not limited to engine, hydraulic components and relief valves.
4. Program updates, calibrations, and pressure adjustments.
5. Diagnostic Time
6. Additional Labor/Labour Time - Above SPG/Labor/Labour Rate
7. Additional Cleaning - Above SPG/Labor/Labour Rate
8. Rental Fees
9. Depreciation or damage caused by normal wear or application, lack of reasonable and proper maintenance, failure to follow operating instructions, misuse, negligence, collision or other accidents.
10. Premiums charged for Overtime Labor/Labour
11. Transportation to and from the dealership.
12. Travel time, mileage or service calls by the dealer.
13. Non-John Deere components or modifications, Rotobec grapples, and attachments installed aftermarket.
14. Shop supplies and maintenance items such as, but not limited to: filters, fuels, oil, hydraulic fluid, lubricants, coolants, conditioners, shop towels, cleaners and degreasers. Note: Reimbursement for refills of oils/coolants lost due to a warrantable failure is covered when a system failure occurs outside the boundaries of a normal oil change (within 25% of specified change interval as provided in the Operator's Manual).
15. Torn, cut, or worn hoses.
16. Wear items, such as, but not limited to: body liner, belts, blades, bulbs, lubricated joints (including pins and bushings), dry brakes, brake linings, dry clutch linings, saw blades, chains, skidder grapple shocks, color marking nozzles, and articulation bumpers.
17. Items such as cutting-edge parts, delimiting knives, bucket teeth and rubber track are not warranted for depreciation or damage caused by normal wear, lack of proper maintenance, misuse, failure to follow operating instructions, the elements or accident.
18. Any defect in a non-covered component, or damage to or failure of a covered component caused by a defect in a non-covered component.
19. Secondary damage which occurs from continued operation of a product after recognition of the occurrence of a failure.
20. Parts supplied or modifications done by third party suppliers.
21. Topping off fluids when fluid levels fall in the range between low and full
22. Parts/Kits not ordered on machine and installed aftermarket. These parts will be covered by any applicable parts warranty.
23. Attachments installed aftermarket – i.e. Winch not installed at factory.
24. Custom options installed outside the factory – i.e. G.R. Manufacturing option packages.
25. Used Products (except as otherwise provided in section L below).

F. TERMINATION OF WARRANTY-

John Deere is relieved of its obligations under Standard Warranty, StructurALL Warranty, Factory-Installed Undercarriage Warranty and/or Extended Warranty if:

1. Service (other than normal maintenance and replacement of service items) is performed by someone other than an authorized John Deere dealer; or
2. The product is modified or altered in ways not approved by John Deere; or
3. Any unapproved or improperly sized attachment is installed on the product. Approval and attachment size shall be at John Deere's sole discretion. (Consult dealer prior to installing attachments or product modification).
4. The product is moved outside the US and/or Canada.

G. PARTS REPLACED UNDER WARRANTY -

Only new or remanufactured parts or components furnished or approved by John Deere, will be used if John Deere elects to repair the product. If any such part or component is defective in material or workmanship when installed in the product, John Deere will repair or replace, as it elects, such defective part or component, provided the defect is

reported to an authorized John Deere dealer within 90 days of installation or before expiration of the applicable Standard Warranty, Factory-Installed Undercarriage Warranty and/or StructurALL Warranty whichever is later.

H. TELEMATICS

NOTICE: Products may be equipped with telematics hardware and software ("Telematics") that transmit data to John Deere/ Dealer. Purchaser may deactivate Telematics at www.idlink.com.

Notwithstanding Purchaser's right, title or interest in the Products, Purchaser agrees that John Deere and Dealer (their affiliates, successors and assigns), without further notice to Purchaser have the right to:

1. Access, use, collect and disclose any data generated by, collected by, or stored in, Products or any hardware or devices interfacing with Products ("Machine Data");
2. Access Machine Data directly through data reporting devices integrated within, or attached to, Products, including Telematics ("Data Reporting Systems"); and
3. Update the Data Reporting Systems software from time to time. Machine Data will only be used in accordance with John Deere's Machine Data Policy, located at www.JohnDeere.com/MachineDataPolicy.

I. OBTAINING WARRANTY SERVICE -

To obtain warranty service, the purchaser must request warranty service from a John Deere dealer authorized to sell the product to be serviced. When making such a request, the purchaser must present evidence of the product's delivery date, make the product available at the dealer's place of business, and inform the dealer in what way the purchaser believes the product to be defective. Standard Warranty, Factory-Installed Undercarriage Warranty and/or StructurALL Warranty repairs may be made in the field if the purchaser and servicing dealer so desire. However, John Deere will not be responsible for any charges (such as dealer travel time, mileage or extra labor/labour) that would not have been incurred had the product been repaired at the dealer's place of business.

J. NO IMPLIED WARRANTY, CONDITIONS OR OTHER REPRESENTATION -

Where permitted by law, neither John Deere nor any company affiliated with it makes any warranties, representations, conditions or promises, express or implied, as to the quality, performance, or freedom from defect of its products, other than those set forth in this document and **NO IMPLIED WARRANTY OF MERCHANTABILITY, CONDITIONS OR FITNESS IS MADE.**

K. NO DEALER WARRANTY -

The selling dealer makes no warranty of its own on any item covered by this warranty, and makes no warranty on other items unless the dealer delivers to the purchaser a separate written warranty certificate specifically warranting the item. **The dealer has no authority to make any representation or promise on behalf of John Deere, or to modify the terms or limitations of this warranty in any way.**

L. USED JOHN DEERE PRODUCTS ONLY -

John Deere will transfer remaining Standard Warranty, Factory-Installed Undercarriage Warranty and/or StructurALL Warranty to the purchaser of a used John Deere construction and/or forestry product that has been used for less than the full warranty period provided at the product's original retail purchase. This transfer is not effective until change of ownership is registered by a John Deere dealer. **ALL THE TERMS, INCLUDING LIMITATIONS AND EXCLUSIONS, OF THE JOHN DEERE STANDARD WARRANTY, FACTORY-INSTALLED UNDERCARRIAGE WARRANTY, AND/OR STRUCTURALL WARRANTY ORIGINALLY PROVIDED FOR THE PRODUCT REMAIN IN EFFECT AND APPLICABLE.**

6092



JOHN DEERE FINANCIAL

Deere Credit, Inc.
PO Box 6600
Johnston, IA 50131-6600

CITY OF FLINT
PO BOX 246
FLINT, MI 48501-0246

Co-Obligor or Guarantor:

See Contract for Details

Dear CITY OF FLINT,

Thank you for choosing John Deere Financial. We appreciate your business and the opportunity to be your trusted financial resource. We are committed to understanding your business, and providing the flexible financing solutions and customer service to accommodate your needs in good and challenging times. Please review and retain the enclosed insert filled with helpful information and too's to get the most from your John Deere Financial experience.

This letter is confirmation that your lease contract described below has been accepted by John Deere Financial and your account is setup. This is not an invoice.

The account number is 030-0063090-016

The details for this transaction include:

LEASE TERM START DATE	07 July 2020
LEASE TERM END DATE	07 July 2025
FIRST PAYMENT DUE DATE	07 July 2020
NUMBER OF PAYMENTS	5

LEASED EQUIPMENT				
QTY.	NEW/ USED	MFR.	MODEL	EQUIPMENT DESCRIPTION
1	NEW	JD	544L	544L WHEEL LOADER
PRODUCT ID NO. 1DW544LHCLF706957				

Equipment Location:
1101 S SAGINAW ST
FLINT, MI 48502-1420

You can easily manage your account or make a payment online by using MYJDFACCOUNT.COM.

If you prefer to mail a payment, please include your account number on the check and mail to:
John Deere Financial, PO Box 4450, Carol Stream, IL 60197-4450

For additional questions, please contact our Customer Service Representatives at 1-800-771-0681.

=====
=====
=====

CERTIFICATE OF COVERAGE - ULTRAGARD PHYSICAL DAMAGE INSURANCE

UltraGard: The Ultimate in Physical Damage Protection!

This certifies that the equipment with an amount shown as "INSURANCE PREMIUM" on the accompanying schedule, for which Deere & Company, Deere Credit Inc., or John Deere Construction & Forestry Company (collectively referred to as John Deere Financial) holds the borrower's, purchaser's, or lessee's (the certificate holder's) contract, with the number shown above, is insured under a policy of physical damage insurance issued by Sentry Select Insurance Company (a stock company), Stevens Point Wisconsin, insuring John Deere Financial's interest, the John Deere dealer's interest and the certificate holder's interest in covered property except as provided elsewhere in this certificate. The insurance shall begin on the earlier of the "INSURANCE EFFECTIVE DATE" in the schedule or date certificate holder takes possession of the covered property and shall terminate, without additional notice when the first of the following occur: (1) Certificate holder's indebtedness to John Deere Financial is discharged (unless certificate holder continues voluntary payments, acceptable to John Deere Financial and us outside bankruptcy) or early termination of the lease agreement; (2) John Deere Financial's security interest in covered property terminates; (3) John Deere Financial or John Deere Financial's designee repossesses covered property; (4) A judgment is entered against the certificate holder on the certificate holder's debt or lease, in favor of John Deere Financial, its assigns or successors, or (5) The "INSURANCE EXPIRATION DATE" shown in the note or lease acceptance form.

This Certificate of Coverage is not a contract of insurance, does not affirmatively or negatively amend, extend or alter the coverage provided by the policy described above and John Deere Financial is not acting as an insurer. The rights of the certificate holder are described in the Certificate of Coverage and based on the policy indicated above issued by Sentry Select Insurance Company (we, us, or our). Certificate holder may request from us, in writing, a copy of the policy on which this certificate is based or view at Deere & Company, 1 John Deere Place Moline Illinois. In the case of loss or damage to covered equipment from a covered cause of loss, the certificate holder must notify Sentry Select Insurance Company as soon as practicable by calling toll free (800) 373-6879. Certificate holder will cooperate with Sentry Select Insurance Company and comply with all Duties In The Event Of Loss Or Damage, including filing of a completed sworn Proof of Loss within 60 days of our request. Failure to do so will void coverage for the certificate holder's interest in the damaged covered property under this policy.

THE FOLLOWING POLICY TERMS DO NOT APPLY UNLESS a certificate of coverage UltraGard physical damage insurance applies and an insurance premium has been paid. This insurance does not apply to repair or overhaul loan contracts.

WARNING: Purchasing this coverage may void or limit other insurance such as a homeowners, farmowners, fire or inland marine policy covering your contents. Please read any such policies you have.

THE CERTIFICATE OF COVERAGE HOLDER HAS 15 DAYS FROM THE DATE THE CERTIFICATE OF COVERAGE IS RECEIVED TO RETURN IT AND CANCEL COVERAGE WITHOUT EARNED PREMIUM. Making a claim for loss or damage to covered property during this 15 day review period shall mean this coverage has been accepted.

The following is a brief summary of the coverages provided under the physical damage coverage provided by Sentry Select Insurance Company.

COVERAGE

Coverage is provided for the equipment, listed as SECURITY on the front of this contract, for loss or damage from a covered cause of loss. Covered causes of loss means risk of direct physical loss or damage except as excluded below.

If SECURITY INCLUDES software programs (such as AutoTrack) for Greenstar, similar GPS systems, or the control system, and you have a loss to the program due to direct physical loss or damage to the Greenstar, GPS system, receiver or control module from a covered cause of loss, and the serial number or other identification number of those systems has been lost or destroyed preventing accurate identification of the covered unit, we will pay the subscription cost to download the replacement described software.

EXCLUSIONS

1. We will not pay for loss or damage caused directly or indirectly by any of the following. Such loss or damage is excluded regardless of any other cause or event that contributed concurrently or in any sequence to the loss or damage from a single event: (a) Seizure or destruction of property by order of governmental authority. But we will pay for acts of destruction ordered by governmental authority and taken at the time of a fire to prevent its spread if the fire would be covered under this Policy. (b) Any weapon employing atomic fission or fusion; or nuclear reaction or radiation, or radioactive contamination from any other cause. But we will pay for direct loss caused by resulting fire if the fire would be covered under this Policy. (c) War, including undeclared or civil war; warlike action by a military force, including action in hindering or defending against an actual or expected attack, by any government, sovereign, or other authority using military personnel or other agents; or insurrection, rebellion, revolution, usurped power, or action taken by governmental authority in hindering or defending against any of these.
2. We will not pay for a loss or damage caused by or resulting from any one of the following: (a) Delay, loss of use, loss of market, or, except as indicated in the Coverage paragraph, any other consequential loss. (b) Unexplained disappearance (except property in the custody of carriers for hire) or shortage found upon taking inventory. (c) Wrongful conversion or other dishonest acts by the certificate holder, certificate holder's employees, or authorized representatives; anyone else with an interest in the property or their employees or authorized representatives; or anyone else to whom the property is entrusted, except carriers for hire. This exclusion applies whether or not such persons are acting alone or in collusion with other persons or such acts occur during the hours of employment. (d) Voluntary parting with any property by the certificate holder, or anyone else entrusted with the property if induced to do so by any fraudulent scheme, trick, device or false pretense. (e) Collision, upset or overturn of covered property to the extent of any loss or damage to the wheels, rims, inner tubes, tires, or rubber tracks of covered property. But, we will pay for loss or damage to wheels, rims, inner tubes, tires, or rubber tracks if the same accident causes other covered loss or damage to the same piece of covered property.
3. We shall not pay for a loss or damage caused by or resulting from any of the following. But if loss or damage by a covered cause of loss results, we will pay for that resulting loss or damage: (a) Faulty material or faulty workmanship in repairing, adjusting, servicing or maintenance operations. (b) Normal wear and tear, hidden or latent defect, gradual deterioration, depreciation, mechanical breakdown, corrosion, rust or dampness. (c) Overheating or freezing of any mechanical system except while in the custody of a carrier for hire.

DEDUCTIBLE

We will not pay for loss or damage in any one occurrence until the amount of the adjusted loss or damage exceeds the deductible. For cotton pickers, and for cotton stripper models that separate, collect, bale, or off-load cotton, the deductible for loss or damage from fire is the larger of \$5,000 or 3% of the purchase price (prior to trade in or other allowances), and \$5,000 for other covered causes of loss. For other covered property the deductible is based on use at the time of the loss and is \$500 for agricultural use or \$1,000 for commercial or industrial use. We will pay the amount of the adjusted loss in excess of the deductible up to the maximum recovery under the Valuation section of this certificate.

VALUATION

The most we will pay for loss or damage to covered property, determined at the time of loss, will be the lesser of the following amounts: (a) The actual cash value of that property. Actual cash value means the amount, at the time of loss or damage, that it would cost to repair or replace covered property with material of like kind and quality less allowance for physical deterioration and depreciation, including obsolescence. (b) The cost of reasonably restoring that property to its condition immediately before loss or damage or replacing the equipment with substantially identical equipment. (c) The original selling or lease price of covered property or the stated value of equipment used as additional collateral.

Any of the certificate holder's, John Deere Financial's, the certificate holder's John Deere dealer's or our acts in recovering, saving, and preserving the covered property shall be considered as done for the benefit of all concerned and without prejudice to the rights of any party. Any expenses for such acts shall be recoverable under this policy provided such costs are reasonable and customary.

In the event of loss or damage to any part of a pair or set, we may repair or replace any part to restore the pair or set to its value before the loss or damage or pay the difference between the value of the pair or set before and after the loss. In the case of loss or damage to any part of covered property consisting of multiple parts, we will only pay the value for the lost or damaged part.

APPRAISAL

If we and the certificate holder, John Deere Financial, or the certificate holder's John Deere dealer disagree on the value of the covered property or the amount of the loss or damage, any of the listed parties may make a written demand for an appraisal. In this event, each party will select a competent and impartial appraiser. The appraisers will then select an umpire. If they cannot agree, any of the listed parties may request that selection be made by a judge of a court having jurisdiction. The appraisers will state separately the value of the property and the amount of the loss or damage. If they fail to agree, they will submit their differences to the umpire. The decision of the umpire will be binding to all parties. Each party will pay its chosen appraiser and bear the other expenses of the appraisal and umpire equally. If there is an appraisal, we will still retain our right to deny the claim. For Nebraska certificate holders, all parties must agree to appraisal. For South Dakota certificate holders, no party may demand an appraisal, and even if performed as agreed by all parties, the outcome and result is nonbinding.

DUTIES IN THE EVENT OF LOSS OR DAMAGE

In addition to the duties outlined in the front of this Certificate of Coverage, in the event of loss or damage to covered property, the certificate holder must also: (a) Notify the police if a law may have been broken, (b) Give us a description of covered property involved as well as how, when, and where the loss or damage occurred; and (c) Permit us to inspect the property and records proving the loss or damage. (d) Send us, as soon as practicable, any legal papers or notices received concerning the loss or damage; (e) Take reasonable steps to protect covered property from further damage and if possible separate damaged property and keep in good order for examination, (f) Permit us to question certificate holder under oath about the claim, including reviewing certificate holder's books and records, as may be reasonably required. Certificate holder's answers must be signed.

CONCEALMENT, MISREPRESENTATION OR FRAUD

Coverage for the certificate holder under this Certificate of Coverage is void in the case of fraud or if the certificate holder intentionally conceals or misrepresents a material fact at any time concerning the coverage provided, covered property, holder's interest in the covered property, or a claim presented under this Certificate of Coverage. For Vermont certificate holders, we may not void coverage, however, may use as a basis to deny the claim or cancel the certificate. This condition does not apply to Nebraska certificate holders.

OTHER INSURANCE

If the certificate holder has any other insurance coverage for the property covered by this Certificate of Coverage, this coverage will apply in excess of the other collectible insurance. (Does not apply to Illinois certificate holders where we will share proportionally with the other insurance)

LEGAL ACTION AGAINST US

No one may bring a legal action against us under this policy unless there has been full compliance with the terms of this policy. The certificate holder must bring any legal action within one year, or the shortest time required by state law, from the date of the loss or damage. For Illinois certificate holders, the time in which suit may be brought is extended by the number of days between date proof of loss is filed and the date the claim is denied in whole or in part. For South Dakota certificate holders, the first sentence of this paragraph does not apply and the second sentence is revised to allow 6 years for legal action. For Vermont certificate holders, the right to bring legal action against us is not conditioned upon your compliance with the provisions of the Appraisal Condition.

LOSS PAYMENT

We will pay for or make good any loss or damage covered under the policy within 30 days (10 working days for Vermont and 15 working days for West Virginia) after (a) Agreement has been reached on the amount of loss or damage; (b) The entry of a final judgment, or (c) The filing of an appraisal award. We will not be liable for any part of a loss or damage that has been paid or is made good by others. If we are covering the certificate holder's interest in covered property, we will adjust the loss with the certificate holder. We will pay any claim for loss or damage, at John Deere Financial's option, to John Deere Financial, for the account of all parties with a covered interest in covered property, or to the certificate holder and the repair facility.

CANCELLATION

The certificate holder may cancel their Certificate of Coverage by mailing or delivering to John Deere Financial a written request to cancel the Certificate of Coverage. If approved John Deere Financial will notify us. If the Certificate of Coverage is cancelled, as soon as practicable, we will send John Deere Financial any pro rata premium refund due for the account of the certificate holder. Cancellation will be effective even if we have not made or offered a refund.

TRANSFER OF RIGHTS OF RECOVERY AGAINST OTHERS TO US

If any person or organization to or for whom we make payment under this insurance has rights to recover damages from another, those rights are transferred to us to the extent of our payment. That person or organization must do everything necessary to secure our rights and must do nothing after loss or damage to impair them.

REINSTATEMENT OF LIMITS AFTER LOSS OR DAMAGE

This coverage will not be reduced by the payment of any claim except for total loss to a piece of covered property, in which event we will refund the unearned premium on that item to John Deere Financial for the account of all interests. Total loss applies when the cost to repair or replace plus any salvage value exceeds the actual cash value, purchase or lease price, or stated value of covered property.

COVERAGE TERRITORY

Coverage only applies to covered property wherever located within or while in transit between locations in the United States of America or the Dominion of Canada.



**JOHN DEERE
FINANCIAL**

PO 20-002397

6092

ALP 7/29/20

Advance Lease Payment Invoice

Due Date:	07/07/2020
Total Due:	\$26,442.59

Billing Address:	Updated Billing Information:
CITY OF FLINT PO BOX 246 FLINT, MI 48501-0246	

Please Note: All future invoices will be sent to the billing address shown unless you update your billing information above.

Master Lease Agreement Number		0063090						
App #	Mfg.	Model #	Serial Number	Due Date	Rental/Tax Amount	Security Deposit	Origination Fee	Advance Lease Payment
217555	JD	544L	1DW544LHCLF70 6957	07/07/2020	\$26,442.59	\$0.00	\$0.00	\$26,442.59

Correspondence Only:	Remit Checks Payable To:
Deere Credit, Inc. Attn: Lease Administration PO Box 6600 Johnston, IA 50131-6600 Phone: (800) 771-0681 – select "lease" prompt Fax: (800) 254-0020 Lease issues only	Deere Credit, Inc. Attn: Acct. Dept. – ALP Processing PO Box 6600 Johnston, IA 50131-6600

TO ENSURE PROPER CREDIT, STAPLE CHECK AND RETURN THIS INVOICE WITH THE LEASE DOCUMENTS.

STAPLE ADVANCE LEASE PAYMENT CHECK HERE

Every Dishonored Check will result in a fee of \$20.00 or an amount not to exceed the highest amount permitted by law.

THIS MULTI-TONE AREA OF THE DOCUMENT CHANGES COLOR GRADUALLY AND EVENLY FROM DARK TO LIGHT WITH DARKER AREAS BOTH TOP AND BOTTOM



JP Morgan Chase
Flint, MI 48502-1650

CITY OF FLINT
COMMERCIAL ACCOUNT 74-1292/724
FLINT MI 48502

00000186244
07/31/2020

Pay This Amount \$26,442.59 ***

Void After 90 Days

TWENTY-SIX THOUSAND FOUR HUNDRED FORTY-TWO AND 59/100 DOLLARS**

Pay AIS CONSTRUCTION EQUIP&CONTRACTORS
To The OR DEERE CREDIT
Order Of PO BOX 6600
JOHNSTON IA 50131-6600

Amanda Juizillo
CITY TREASURER

⑈0186244⑈

⑆072000326⑆

937809507⑈

THIS ORIGINAL DOCUMENT HAS A REFLECTIVE WATER MARK ON THE BACK. HOLD AT AN ANGLE TO VIEW WHEN CHECKING THE AUTHENTICITY.

Vendor ID 000000003
AIS CONSTRUCTION EQUIP&CONTRACTORS
OR DEERE CREDIT
PO BOX 6600
JOHNSTON IA 50131-6600

CITY OF FLINT
1101 S SAGINAW ST
FLINT MI 48502

Check Date: 07/31/2020

Check No 00000186244

HC	Invoice Number	Invoice Dat	Voucher ID	Gross Amount	Discount Available	Paid Amount
JD	0063090 APP#217555	07/07/2020	388796	26,442.59		26,442.59

Check Number	Date	Total Amount	Late Interest	Discounts Taken	Total Paid Amount
00000186244	07/31/2020	26,442.59		0.00	26,442.59

For Accounts Payable Information: Phone (810) 766-7263



JOHN DEERE FINANCIAL

Lease Schedule

Lease Schedule No.	030-0063090-016
Master Lease Agreement No.	0063090

Lessee: (Name & Address)	CITY OF FLINT 1101 S SAGINAW ST, FLINT, MI 48502-1420
Lessor:	DEERE CREDIT, INC. 6400 NW 86 th ST, PO BOX 6600, JOHNSTON, IA 50131-6600

LEASE TERM

Lease Term Start Date	Lease Term End Date	# Of Payments	Lease Payment	*Sales/Use Tax	Total Lease Payment	Purchase Option Price
07/07/2020	07/07/2025	5	\$26,442.59	\$0.00	\$26,442.59	\$78,220.32

*If part of the regular scheduled lease payment

RENEWAL TERM

Renewal Term Start Date	Renewal Term End Date	# Of Payments	Renewal Lease Payment Amount	Sales/Use Tax	Total Renewal Lease Payment	Purchase Option Price

PAYMENT TERMS

PAYMENT DUE AT SIGNING

Due Date	1 st Payment Due Date	Discount Rate	Advance Lease Payment**	
07	07/07/2020	Internal Rate of Return minus 2 percent (2%)		\$26,442.59
Billing Period	Irregular Payments		Origination Fee	\$0.00
			Security Deposit	\$0.00
			Total Due At Signing	\$26,442.59

Monthly
 Quarterly
 Semi-Annual
 Annual
 Irregular

**Advance Lease Payment includes the first (1) and last (0) Lease Payment(s)

"Master Agreement" shall mean the above referenced Master Lease Agreement. "Schedule" shall mean this Lease Schedule. "Lease" shall mean this Schedule and the Master Agreement. All of the terms and conditions set forth in the Master Agreement and any amendment, addendum, schedule or attachment thereto or hereto including, but not limited to, the Equipment Return Provisions are hereby incorporated into and made a part of this Schedule.

Lease Payments. You agree to remit the Lease Payments (and applicable sales, use and property taxes) on the dates noted above and all other amounts when due to: DEERE CREDIT, INC., P.O. Box 4450, Carol Stream, IL 60197-4450.

Hourly Charge. You certify that the engine hour meter reading on each item of Equipment is accurate as of the date you sign this Schedule. If you use any Equipment during the Lease Term for more than the Engine Hourly Limit indicated above for that item of Equipment, you will pay to us within 10 days of the Lease Term End Date (or any earlier termination of the Lease) an amount equal to the Excess Hour Charge for that item of Equipment for each engine hour in excess of the Engine Hourly Limit. If the Lease is terminated, cancelled or extended for any reason, the Hourly Limit will be prorated by us in our sole discretion.

Purchase Option. You may purchase the Equipment on the Lease Term End Date (or the Renewal Term End Date) for the applicable Purchase Option Price (plus applicable Taxes including estimated property taxes), provided (1) you are not in default; and (2) we receive the Purchase Option Price and any other amounts you owe us on or before the Lease Term End Date (or the Renewal Term End Date). Upon receipt of the Purchase Option Price, we will transfer to you all of our right, title and interest in such item(s) of Equipment AS-IS, WHERE-IS, WITHOUT ANY WARRANTY AS TO CONDITION OR VALUE.

Renewal Term. If (1) a Renewal Term is provided for above, and (2) you notify us at least sixty (60) days prior to the end of the Lease Term that you intend to renew the Lease for the Renewal Term, the Lease shall renew for the Renewal Term. You agree to remit to us the Renewal Lease Payments indicated above (plus applicable taxes and other amounts) when due and payable each Billing Period, even if we do not send you a bill or an invoice.

Representations and Warranties. You represent and warrant to us, as of the date you signed this Schedule, that (1) the Equipment was selected by you; (2) the Equipment (including all manufacturer manuals and instructions) has been delivered to, and examined by, you; (3) the safe operation and the proper servicing of the Equipment were explained to you; (4) you received the written warranty applicable to the Equipment and understand that your rights under the written warranty may be limited; (5) the Equipment is unconditionally and irrevocably accepted by you as being suitable for its intended use; (6) the Equipment is in good condition and repair (operating and otherwise); (7) the Equipment shall be used only for the purpose indicated herein; (8) except as disclosed to us, neither you nor any person related to you will have an equity interest in the Equipment on the Lease Term Start Date; and (9) all information provided to us by you is true and correct.

You acknowledge and agree that: (1) we did not select, manufacture or supply any of the Equipment; (2) we acquired the Equipment at your direction; (3) you selected the supplier of the Equipment; (4) you are entitled to all manufacturer warranties ("Warranty Rights") and we assign all Warranty Rights to you, to the extent assignable; (5) you may request an accurate and complete statement of the Warranty Rights, including any disclaimers and limitations, directly from the manufacturer; and (6) you assign to us all your rights (but none of your obligations) under all purchase orders, purchase agreements or similar documents relating to the Equipment. You waive all rights and remedies conferred upon a lessee under Sections 508 - 522 of Article 2A of the Uniform Commercial Code.

Lease Payments may be based on the assumption that we will be entitled to certain tax benefits as the owner of the Equipment. If you take or fail to take any action that results in a loss of such tax benefits, you will pay us, on demand, the amount we calculate as the value of such lost tax benefits.

Miscellaneous. You agree that we can access any information regarding the location, maintenance, operation and condition of the Equipment, and you irrevocably authorize anyone in possession of such information to provide all of that information to us upon our request. You also agree to not disable or otherwise interfere with any information-gathering or transmission device within or attached to the Equipment. You permit us to monitor and record telephone conversations between you and us. By providing any telephone number, including a mobile phone number, to us, any of our affiliates or any debt collectors we retain, we, such affiliates and such retained debt collectors can contact you using that number, including calls using an automatic dialing and announcing device and prerecorded calls, and that such calls are not "unsolicited" under state or federal law. All of our rights under each Lease shall remain in effect after the expiration of the Lease Term or termination of the Schedule.

You acknowledge and agree that, if You execute this Lease Agreement with your electronic signature, (a) you are signifying your intent to enter into this Lease Agreement and that this Lease Agreement be legally valid and enforceable in accordance with its terms to the same extent as if you had executed this Lease Agreement using your written signature, and (b) this Lease Agreement is an electronic record executed by you using your electronic signature. You agree that unless the authoritative electronic copy of this Lease Agreement ("Authoritative Copy") is converted to paper and marked as the original by us (the "Paper Contract"), the Authoritative Copy shall at all times reside in a document management system designated by us for the storage of authoritative copies of electronic records (the "DMS"), and shall be deemed held in the ordinary course of business. In the event the Authoritative Copy is converted to a Paper Contract, you acknowledge and agree that (1) your signing of this Lease Agreement also constitutes issuance and delivery of such Paper Contract, (2) your electronic signature associated with this Lease Agreement, when affixed to the Paper Contract, constitutes your legally valid and binding signature on the Paper Contract, and (3) your obligations will be evidenced by the Paper Contract alone after such conversion.



JOHN DEERE
FINANCIAL

Physical Damage/Liability Insurance

Lease Schedule No.	030-0063090-016
Master Lease Agreement No.	0063090

Lessee: (Name & Address)	CITY OF FLINT 1101 S SAGINAW ST. FLINT, MI 48502-1420
Lessor:	DEERE CREDIT, INC. 6400 NW 86 th ST, PO BOX 6600, JOHNSTON, IA 50131-6600

LIABILITY INSURANCE on the above referenced Lease Schedule (the "Schedule") to the above referenced Master Lease Agreement will be provided by the following insurance agency:

Name of Agency: _____ Phone Number of Agency: _____

Mailing Address of Agency: _____ Fax Number of Agency: _____

PHYSICAL DAMAGE INSURANCE on the Schedule will be provided by the following agency:

Name of Agency: _____ Phone Number of Agency: _____

Mailing Address of Agency: _____ Fax Number of Agency: _____

If an insurance certificate is available, it should be provided in place of the above information

ADDITIONAL INSURED and LOSS PAYEE:
Deere Credit, Inc.
Its Successors &/or Assigns
6400 NW 86th St
Johnston, IA 50131

The undersigned agrees and understands that, pursuant to the provisions of Section 6 of the Master Lease Agreement, the undersigned must at all times (1) maintain public liability insurance, covering personal injury and property damage for not less than \$1,000,000 per occurrence, naming us (and our successors and assigns) as additional insured; and (2) keep the Equipment insured against all risks of physical damage for no less than its Termination Value (as such term is defined in Section 7 of the Master Lease Agreement), naming us (and our successors and assigns) as sole loss payee.

LESSEE
CITY OF FLINT
1101 S SAGINAW ST
FLINT, MI 48502-1420

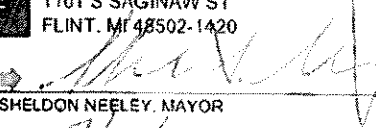
By: 
SHELDON NEELEY, MAYOR

Date: 7/17/20

Office Use Only

Contact Date(s):	Contact Name:
Liability Insurance Company Policy #:	Liability Insurance Expiration Date:
Liability Limits:	Notes:
Physical Damage Insurance Company and Policy #	Physical Damage Insurance Expiration Date:
Insured Value:	Notes:
Loss Payee Deere Credit, Inc.? <input type="checkbox"/> Yes <input type="checkbox"/> Will Be Added	Verified By:



**JOHN DEERE
FINANCIAL**

Property Tax Acknowledgment

Lease Schedule No.	030-0063090-016
Master Lease Agreement No.	0063090

Lessee: (Name & Address) **CITY OF FLINT**
1101 S SAGINAW ST, FLINT, MI 48502-1420

Lessor: **DEERE CREDIT, INC.**
6400 NW 86th ST, PO BOX 6600, JOHNSTON, IA 50131-8600

As Lessor and Owner of the equipment, Deere Credit, Inc. is responsible for filing and paying property tax to the appropriate taxing authority. Lessee should not report this equipment on their property tax return.

Lessor will bill Lessee for property taxes upon receipt of an assessment from the taxing authority. Lessee will reimburse Lessor for property taxes upon receipt of an invoice from John Deere Financial. Please refer to section 3 of the Master Lease Agreement for further information.

The equipment listed on the attached Master Lease Schedule – Equipment List will be reported to the following taxing jurisdiction(s).

1101 S SAGINAW ST Check here if OUTSIDE city limits
Street Address

FLINT MI 48502- GENESEE
City State Zip County

PLEASE VALIDATE THE ABOVE INFORMATION & MAKE APPLICABLE CHANGES BELOW:

Street Address Check here if OUTSIDE city limits

City State Zip County

Check here if Sales/Use Tax Exempt Check here if Property Tax Exempt

Equipment Usage: _____

Percentage of Time: _____

The undersigned (the "Lessee") acknowledges that they have verified the equipment location listed above; understands that the Lessor will file and pay property taxes and that the Lessee is required to reimburse Lessor upon receipt of an invoice for property taxes. Failure to reimburse Lessor for property taxes shall constitute an Event of Default as described in Section 10 of the Lease.

LESSEE **CITY OF FLINT**
1101 S SAGINAW ST
FLINT, MI 48502-1420

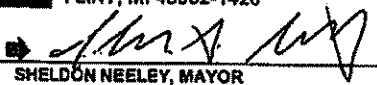
By: 
SHELDON NEELEY, MAYOR

Date: 7-17-20



JOHN DEERE FINANCIAL

Equipment Return Provisions

Lease Schedule No.	030-0063090-016
Master Lease Agreement No.	0063090

Lessee: (Name & Address)	CITY OF FLINT 1101 S SAGINAW ST, FLINT, MI 48502-1420
Lessor:	DEERE CREDIT, INC. 6400 NW 86 th ST, PO BOX 6800, JOHNSTON, IA 50131-6600

The following Equipment Return Provisions are hereby incorporated into and made a part of the above referenced Master Lease Agreement (the "Master Agreement"), and entered into between Deere Credit, Inc., as Lessor ("us", "we" or "our"), and CITY OF FLINT, as Lessee ("you" or "your"). Pursuant to Section 9 of the Master Lease Agreement, all Equipment must be returned to us in satisfactory condition. Unsatisfactory condition shall include any condition described in Sections 1 through 4 below ("Excessive Wear and Tear").

1. **Mechanical.**
 - A. Computer systems or safety and emission control equipment not in proper working order.
 - B. Mechanical components that are missing, broken or unsafe or that do not operate normally, other than normal tune-ups, given the age of the equipment.
 - C. Wear on power train assembly that exceeds manufacturer's then current standards for normal wear and tear.
 - D. Any air filters not within manufacturer's specifications.
 - E. Any gauges or fluid indicators that are damaged or do not function, the electrical system fails to operate properly, the battery fails to hold a charge or any wire harnesses that are not tied down and kept secured, dry and clean.
 - F. Any pumps, motors, valves or cylinders not in good operating condition or that fail to meet manufacturer's rated specifications or hydraulic system exceeds manufacturer's then-current contaminant standards (as shown by oil sample analysis). Equipment not serviced according to the manufacturer's operating manual.
 - G. Any lubricant, water or A/C seal leaks.
2. **Exterior.**
 - A. Dents larger than 2 inches in diameter.
 - B. Excessive number of dents or scratches.
 - C. Any scratch 8" or longer that reaches the metal skin.
 - D. Any single chip the size of a quarter or larger or multiple small chips within one square foot.
 - E. Substandard paint repairs, such as peeling, bubbling or mismatched shades that evidence poor condition in comparison with original paint and require repainting at a cost in excess of \$200.
 - F. Rust holes in the body metal or a rust spot that covers more than a 4-inch square area.
 - G. Any glass that must be replaced due to cracks or missing glass and any windshield damages greater than \$50 in amount.
 - H. All frame damage and substandard frame repairs.
 - I. Any tires or tracks that (a) have broken side walls or excessive cuts or damages, or (b) have less than 50% of the original useful life remaining, or (c) are not of the same size, type grade or equivalent quality manufacturer as were originally included on the Equipment.
3. **Cab/Operator Platform.**
 - A. Heavy interior soil or strong odors, such as manure, that cannot be removed by general cleaning.
 - B. Unclean condition of operator environment.
 - C. Holes, tears, or burns on the dash, floor covers, seats, headliners, upholstery or interior.
4. **General.**
 - A. Equipment not operated or maintained in accordance with the manufacturer's specifications or if components, fuels or fluids, on or in connection with the Equipment that do not meet manufacturer's standards were used.
 - B. Any other damage that in the aggregate costs \$250 or more to repair or that makes the Equipment unlawful or unsafe to operate.
5. **Other.**
 - A. All warranty and PIP work must be completed prior to the Lease Term End Date of the Lease Schedule relating to the Equipment.
 - B. The Equipment must be cleaned prior to its return.
 - C. The Equipment must be prepared for storage according to the operators manual, including flushing the system and use of winterization fluid.
6. **Hour Meter.** For each item of Equipment returned with a broken or missing hour meter, you shall accept an invoice from us and remit to us an amount equal to \$1,000. You agree that the hour meter included with the Equipment is conclusive of the number of hours of Equipment use.
7. **Invoices for Excess Wear And Tear.** Upon any return of the Equipment, we shall, in our sole discretion, determine the existence of any Excessive Wear and Tear. In the event any item of Equipment is returned to us with Excessive Wear and Tear, you shall, at our sole discretion, either (i) accept an invoice from us and remit to us the cost of repairing or replacing the affected component(s) which we determine necessary to return the Equipment to its required condition, and/or (ii) accept an invoice from us and remit to us an amount equal to our estimate of (1) the cost of new tires or tracks if the tires or tracks are damaged due to broken side walls or excessive cuts or damage, or (2) the cost of new tires or tracks multiplied by the difference between (A) our estimate of the percentage of the useful life of the tires and tracks then remaining, and (B) fifty percent (50%). For example, if you return Equipment with tires having 20% of their useful life remaining, you would remit to us an amount equal to 30% of the cost of new tires ((50% - 20%) multiplied by the cost of new tires). Your failure to remit the required payment to us within ten (10) days of demand shall constitute a default by you under the terms of the Lease.

LESSEE	CITY OF FLINT 1101 S SAGINAW ST FLINT, MI 48502-1420
By:	_____
	SHELDON NEELEY, MAYOR
Date:	_____

LESSOR	DEERE CREDIT, INC. 6400 NW 86 th ST, PO BOX 6800 JOHNSTON, IA 50131-6600
By: _____	_____
Date: _____	_____



**JOHN DEERE
FINANCIAL**

Delivery and Acknowledgment

Lease Schedule No.	030-0063090-016
Master Lease Agreement No.	0063090

Lessee: <small>(Name & Address)</small>	CITY OF FLINT 1101 S SAGINAW ST, FLINT, MI 48502-1420
Lessor:	DEERE CREDIT, INC. 6400 NW 86 th ST, PO BOX 6600, JOHNSTON, IA 50131-6600

Capitalized terms shall have the meanings set forth in the above referenced Master Lease Agreement.

Lessee hereby represents and warrants that: (1) all of the Equipment more fully described in the above referenced Lease Schedule was selected by Lessee; (2) all of the Equipment and the Operator's Manuals have been delivered to, and received by, Lessee; (3) all of the Equipment has been inspected by Lessee and is in good working order; (4) all of the Equipment is unconditionally and irrevocably accepted by Lessee for all purposes under the Lease; (5) the safe operation and the proper servicing of the Equipment have been explained to Lessee; (6) Lessee received the manufacturer's written warranty applicable to the Equipment and Lessee understands that its rights are subject to the limitations outlined therein; (7) no Event of Default has occurred and is continuing; and (8) no material adverse change in the financial or business condition of Lessee has occurred since the date of the last financial statement submitted to Lessor by Lessee.

Signed by Lessee's duly authorized representative on the date shown below.

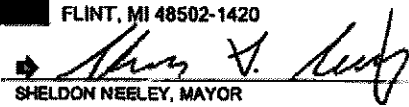
<p>LESSEE</p> <p>CITY OF FLINT 1101 S SAGINAW ST FLINT, MI 48502-1420</p> <p>By:  SHELDON NEELEY, MAYOR</p> <p>Date: <u>7-17-20</u></p>	<p>LESSOR</p> <p>DEERE CREDIT, INC. 6400 N.W.86th STREET, PO BOX 6600 JOHNSTON, IA 50131-6600</p> <p>By: _____</p> <p>Date: _____</p>
--	--

John Deere Financial Direct Pay-Recurring Enrollment

For Credit Card accounts and Installment Loans

Fax 800-826-9527

Or Mail: John Deere Financial, Attn: Payment Specialist, PO Box 5327, Madison, WI 53705

Lease

Fax to 800-254-0020

Or Mail: John Deere Financial, Attn: Lease Dept, PO Box 6600, Johnston, IA 50131-6600

Eligibility

Your account with John Deere Financial must be **current** in order to enroll for the Direct-Pay Recurring payment option. Your account with your financial institution must allow automatic withdrawals.

How to Enroll

Complete and sign the authorization form below. Please be sure to provide all information requested.

Bank & account information, whether it is a saving or checking account. For the typical checking accounts the account information is located similar to the sample business or personal checks below.

Sample Personal Check

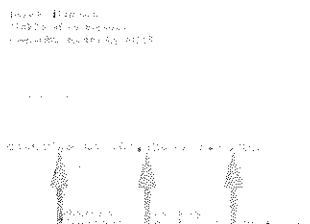

Sample Business Check

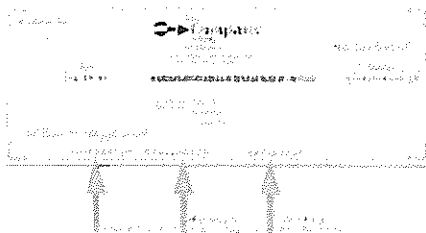

JOHN DEERE FINANCIAL DIRECT PAY-RECURRING AUTHORIZATION FORM

My signature below authorizes Deere Credit Services, Inc. and its affiliates, (the Company), to initiate debit entries to the checking/savings account below for the regularly scheduled payments or other amounts that I may owe the Company. This authorization is to remain in full force and effect until canceled by the Company, or by written notification from me, given in such time and manner as to allow the Company a reasonable opportunity to act upon it.

If your account is closed due to an Add-On transaction, consolidation or corrected loan agreement and you have Direct Pay-Recurring, your enrollment and banking information will be transferred to your new account.

Bank Name _____

John Deere Financial Account Number _____

Bank City & State _____

Name on John Deere Financial Account _____

Name on Bank Account _____

Social Security Number/Federal Tax ID _____

9 digit Bank Routing and Transit # _____

Type of Account: Checking Savings

Bank Account Number _____

I request Direct Pay Recurring to begin with my payment due ____/____/____.

I understand any payment due prior to the month I requested above, must be made in order to be eligible for Direct Pay Recurring.

Bank Account Owner Signature _____ Date _____

Bank Account Owner Phone Number _____

**Claim for Exemption of
State and Local Sales/Use Tax for
Municipal and Tribal Entities**

Seller

Name: Deere Credit Inc.

Address: 6400 NW 86th St. Johnston, IA 50131

Purchaser

Name: CITY OF FLINT

Address: 1101 S SAGINAW ST, FLINT, MI 48502

ID Number (If Applicable): _____

Exemption Number (if applicable): _____

Description of Item Being Purchased

Quantity	Year	Make	Model	Equipment Description
1	2020	JD	544L	WHEEL LOADER

By signing below, purchaser certifies that the items being purchased are exempt from state and local sales tax.

By: _____

Title: _____

Date: _____

Telephone Number: _____

Version 2 updated March 27 2018

190027

(Bid #19000015)

SUBMISSION NO.: _____

PRESENTED: 2-6-19

ADOPTED: 2-11-2019

RESOLUTION TO AIS CONSTRUCTION EQUIPMENT FOR THE LEASE OF TWO JOHN DEERE BACKHOE TRACTORS AND ONE FRONT END WHEEL LOADER

BY THE CITY ADMINISTRATOR:

RESOLUTION

The Fleet Department is requesting the issuance of a purchase order to lease two John Deere backhoe tractors and one front end wheel loader; and

AIS Construction Equipment, 5655 Pontiac Trail, New Hudson, MI was the lowest vendor to submit a price and has submitted a cost to lease said equipment through the State of Michigan MiDeal program contract #071B7700090 and based upon the best financing lease/purchase option over five years with Deere Credit, Inc.. Funding for said services will come from the following account: 661-451.100-940.000; and

IT IS RESOLVED, that the Department of Purchases and Supplies, upon City Council's approval, is hereby authorized to issue a purchase order to AIS Construction Equipment for a five year lease of two John Deere backhoes tractors and one front end wheel loader in an annual amount not to exceed \$54,483.92 and an aggregate amount of \$272,419.60. If the City decides to purchase said equipment at the end of the lease, the additional purchase cost will be \$236,239.00 for a total purchase of \$508,658.60. (Fleet/Central Garage Fund) \$54,483.92 FY19, \$54,483.92 FY20, \$54,483.92 FY21, \$54,483.92 FY22. If final purchase is made, an additional \$428,473.00 will be in FY22.

APPROVED PURCHASING DEPT:

Bryan D. Bond
Michigan Purchasing Manager

APPROVED AS TO FINANCE

Hughie Newsome
Chief Financial Officer

APPROVED AS TO FORM:

Angela Wheeler
Chief Legal Officer

Steve Branch, City Administrator

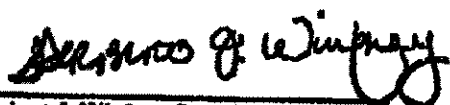
Herbert J. Winfrey, President
City Council



JOHN DEERE

Customer Purchase Order for John Deere Construction and Forestry Products - USA

PURCHASER NAME AND ADDRESS (First Signer)			
NAME (First, Middle, Last)			
City of Flint			
STREET or RR 702 W. 12th Street			
CITY Flint	STATE MI	ZIP CODE 48502	COUNTY Genesee
PHONE NUMBER		EMAIL ADDRESS	
PURCHASER NAME AND ADDRESS (Second Signer)			
NAME (First, Middle, Last)			
STREET or RR			
CITY	STATE	ZIP CODE	COUNTY
PHONE NUMBER		EMAIL ADDRESS	

DEALER NAME AND ADDRESS			
DEALER NAME AIS Construction Equipment Corp.			Dealer Account No.: 17-8022
STREET or RR 56555 Pontiac Trail			
CITY New Hudson	STATE MI	ZIP CODE 48165	Date of Order: 3/31/2020
Dealer Order No.:		TYPE OF SALE: LEASE	
PURCHASER TYPE: 5 City/Town/Village		MARKET USE CODE: 98 Undefined Government Use	
Add purchaser to Mailing List (Check One or More)			
<input type="checkbox"/> Construction <input type="checkbox"/> Utility <input type="checkbox"/> Forestry <input checked="" type="checkbox"/> Government			
PURCHASER IS:		Purchaser Acct.:	
<input type="checkbox"/> Business <input type="checkbox"/> Individual		53715	
<input type="checkbox"/> SOCIAL SECURITY <input type="checkbox"/> IRS TAX ID NO <input type="checkbox"/> EIN			
NO.:			

EXTENDED WARRANTY IS:	LOCATION OF FIRST WORKING USE:	STATE	COUNTY CODE
<input type="checkbox"/> Accepted <input checked="" type="checkbox"/> Rejected _____ (Initials)	County Genesee City Flint	MI	049

Ultimate Uptime Package Purchased:					<input type="checkbox"/> Yes <input type="checkbox"/> No	_____ Initials		
QTY	NEW	DEMO	RENT	USED	EQUIPMENT (Model, Size, Description)	Hours of Use	PIN or Serial Number	Delivered Cash Price
1	<input checked="" type="checkbox"/>	<input type="checkbox"/>	<input type="checkbox"/>	<input type="checkbox"/>	John Deere 410L Backhoe	4	1T0410LXHLF386242	\$124,178.00
					As per quote dated 1/14/2020			
					5 Year Governmental Operating Lease			
					with 5 Annual Payments of \$18,506.40 each			
					Then return or purchase for \$54,528.00			
(1) TOTAL CASH PRICE								\$124,178.00

QTY	TRADE-IN (Model, Size, Description)	Hours of Use	PIN OR SERIAL NUMBER	AMOUNT
ACKNOWLEDGMENTS: Purchaser offers to sell, transfer, and convey the item(s) listed as "Trade In" to the Dealer at or prior to the time of delivery of the above product(s), as a "trade-in" to be applied against the cash price. Purchaser represents that each "trade-in" item shall be free and clear of all security interests, liens, and encumbrances at the time of transfer to the Dealer except to the extent shown below. The price to be allowed for each "trade-in" item is listed on this document. The Purchaser promises to pay the balance due (line 9) shown hereon in cash, or to execute a Time Sale Agreement (Retail Installment Contract), or a Loan Agreement for the purchase price of the Product(s), plus additional charges shown thereon, or to execute a Lease Agreement, on or before delivery of the equipment ordered herein. Despite delivery of the Product(s) to the Purchaser, title shall remain with the Seller until one of the foregoing is accomplished. The Purchaser and the Dealer agree that this Purchase Order is not a security agreement and that delivery of the Product(s) to the Purchaser pursuant to this Purchase Order will not constitute possession of the Product(s) by the Purchaser, as a debtor, for the purposes of the purchase money security provisions in any statutes relating to personal property security or its equivalent. Purchaser understands that its rights in connection with this purchase are limited as set forth in this Purchase Order.				
(2) TOTAL TRADE-IN ALLOWANCE				
(3) BALANCE (1-2)				\$124,178.00
(4) SALES TAX RATE _____ %				\$0.00
(5) ADDITIONAL FEES				
(6) SUBTOTAL (3 & 4 & 5)				\$124,178.00
(7) RENTAL APPLIED				
(8) CASH WITH ORDER				
(9) BALANCE DUE (6-(7 & 8))				\$124,178.00

DISCLOSURE OF REGULATION APPLICABILITY: When operated in California, any off-road diesel vehicle may be subject to the California Air Resources Board In-Use Off-Road Diesel Vehicle Regulation. It therefore could be subject to retrofit or accelerated turnover requirements to reduce emissions of air pollutants. More information is available on the California Air Resources Board website at <http://www.arb.ca.gov/msprog/offroadel/ordiesel.htm>.

IMPORTANT WARRANTY NOTICE: The Standard Warranty for new John Deere construction and forestry products is set forth in a separate document provided by the dealer. Please read the Standard Warranty carefully before signing. No express warranty is made unless specified in the Warranty Statement. PURCHASER'S RIGHTS AND REMEDIES PERTAINING TO THIS PURCHASE ARE LIMITED AS INDICATED IN THE STANDARD WARRANTY AND PURCHASE ORDER. WHERE PERMITTED BY LAW, NO IMPLIED WARRANTY OF MERCHANTABILITY, CONDITIONS OR FITNESS IS MADE.

TERMS & CONDITIONS VERIFICATION STATEMENT

Use of John Deere Data Services ("Services"), if applicable, and all rights and obligations of John Deere and the Purchaser (or "Customer" as identified in the applicable agreement), are governed by the terms and conditions outlined in the Warranty Statement and the applicable John Deere Construction & Forestry Company Subscriptions & Data Services Dealer Agreement and/or Customer Data Services agreements available at www.JohnDeere.com/Agreements. Purchaser agrees to be bound by these terms and conditions if Purchaser activates or otherwise uses any of the Data Services. If Purchaser does not agree to these terms and conditions, Purchaser must not activate or otherwise use the Data Services.

The undersigned purchaser(s) (the "Purchaser") hereby orders the product(s) (the "Product") described above from the Dealer. The Dealer shall not be liable for failure to provide the Product or for any delay in delivery if such failure or delay is due to the Dealer's inability to obtain such Product from the manufacturer or supplier or other cause beyond the Dealer's control. The cash price shown above is subject to the Dealer receiving the Product from the manufacturer or supplier prior to any change in price by the manufacturer or supplier and is also subject to any new or increased taxes being imposed upon the sale of the Product after the date of this Purchase Order.

Purchaser's signature below acknowledges the Purchaser has received a copy of the Standard Warranty, Version _____ (Initials) _____ and understands its terms and conditions.

Purchaser (First Signer) _____	Signature _____	Date 3/31/2020
Purchaser (Second Signer) _____	Signature _____	Date _____
Dealer Representative _____	Signature 	Date _____
Salesperson Chris Robinson	Signature _____	Date 3/31/2020

DELIVERY ACKNOWLEDGEMENT	Delivered with Operator's Manual On: 7/28/2020	Purchaser Signature:
--------------------------	---	----------------------

STANDARD WARRANTY FOR NEW JOHN DEERE CONSTRUCTION, UTILITY, CCE AND FORESTRY PRODUCTS – US & Canada

- **Construction, Forestry & Compact Construction Equipment (CCE) Products***: 12 months Full Machine Standard Warranty
- *** Compact Construction Equipment Products** Delivered and settled on or after 01 June 2018: 24 months or 2000 hours (whichever comes first) Full Machine Standard Warranty
- **C&E Series Pull-Type Scrapers**: 6 months Full Machine Standard Warranty
- **DC & DE Series Pull-Type Scrapers**: 12 months Full Machine Standard Warranty
- **Scraper Tractors**: 24 Months or 2000 Hours (whichever occurs first) Full Machine Standard Warranty
- **Forestry Attachments**: 12 Months or 2000 Hours (whichever occurs first) Full Machine Standard Warranty
- **Frontier Equipment**: 6 months Full Machine Standard Warranty (90 days in rental applications)

The "Standard Warranty" is part of the warranty protection package available from John Deere Construction & Forestry Company (John Deere Limited in Canada) ("John Deere") to purchasers of new John Deere products ("product"):

STANDARD Warranty is John Deere's standard new product warranty, described in this document, provided at no additional charge to the purchaser.

EXTENDED Warranty is a separate repair contract made available by John Deere for purchasers who wish to complement their Standard Warranty coverage. Complete Extended Warranty details, including coverage options and limitations, are set forth in the Application for Extended Warranty, which is available from authorized John Deere dealers.

STRUCTURALL Warranty applies to certain structural components as listed below and as described in this document.

FACTORY-INSTALLED UNDERCARRIAGE Warranty applies to certain undercarriage components as listed below and as described in this document.

A. STANDARD WARRANTY - GENERAL PROVISIONS

John Deere will repair or replace, at its option, any parts (except those specified below) of a new John Deere product that, as delivered to the original retail purchaser(s), are defective in material or workmanship. Performance of this warranty will be free of charge for parts and labor/labour, except as otherwise stated below. Standard Warranty applies only to purchases from John Deere and authorized John Deere dealers and, except as otherwise provided in the next sentence and section L below, is extended only to the original retail purchaser of the product. Remaining Standard Warranty applicable to a used John Deere product is transferred to a subsequent purchaser of the product only if the subsequent purchaser requests a transfer from an authorized John Deere dealer before the product's Standard Warranty expires. Coverage begins on the date of delivery of the product to the original retail purchaser. For purposes of this warranty, a product that has been rented, used for demonstration purposes for 150 or more hours, or otherwise used prior to its original retail purchase has been "used" for the total duration of such use. Warranty statements required by law covering engine emissions-related parts and components are found on a separate written warranty certificate provided to the purchaser at the time of the original retail purchase.

B. WHAT IS COVERED BY STANDARD WARRANTY -

All parts of a new John Deere product (except those noted in Sections D and E below) are covered during the Standard Warranty period set out above.

C. EXCLUSIVE REMEDY -

The repair or replacement of covered parts or components that are defective, as provided in Sections A, B, D.2 and D.3 herein, shall be the purchaser's exclusive remedy for any defect in the product. However, if after repeated attempts such repair or replacement fails to correct the performance problem caused by the defect, the purchaser's sole remedy shall be a refund of the amount paid for the product (in exchange for a return of the product), excluding any transportation charges, license fees, taxes and insurance premiums, and less a reasonable allowance for use of the product prior to its return. In no event will the dealer, John Deere or any company affiliated with John Deere be liable for any incidental or consequential damages, including but not limited to loss of profits, rental of substitute equipment or other commercial loss. Correction of defects in the manner provided above shall constitute fulfillment of all liabilities of the Dealer, John Deere, or any company affiliated with John Deere to the purchaser or any other

person, whether based upon contract, tort, strict liability, or otherwise. This limitation does not apply to claims for personal injury.

D. ITEMS COVERED SEPARATELY -

1. **Standard Warranty** does not apply to batteries, radios, tires, cameras, or to Cummins, MTU or Detroit Diesel Engines installed in John Deere products, which are covered by separate written warranties.
2. **Factory-Installed Undercarriage Warranty** covers all non-rubberized factory-installed undercarriage wear components for 3 years or 4,000 hours from the date of delivery to the original retail purchaser, whichever occurs first (unless terminated earlier under Section F, below). For purposes of this warranty, a product that has been rented, used for demonstration purposes for 150 or more hours, or otherwise used prior to its original retail purchase has been "used" for the total duration of such use. In addition to the items listed in section E below, **Factory-Installed Undercarriage Warranty** does not cover: failures due to wear, machine application, maintenance practices, or improper machine configuration; removal and installation labor/labour; transportation or hauling costs; unapproved parts; non-wear items; and rubberized undercarriage components such as rubber tracks. **Warranty claims will be pro-rated based upon wear of the failed component and whether track shoe width is approved by John Deere. Factory-Installed Undercarriage Warranty does not apply to Scraper Tractors.**
3. **StructurALL Warranty** for new John Deere Products (except Compact Excavators & Loaders, Skid-Steer Loaders, Compact Track Loaders, Scraper Tractors, Pull-Type Scrapers, and Forestry Attachments, which are not eligible for **StructurALL Warranty**) begins at the date of delivery to the original retail purchaser and ends (unless terminated earlier under Section F, below) after three (3) years, or 10,000 hours (whichever occurs first). For purposes of this warranty, a product that has been rented, used for demonstration purposes for 150 or more hours, or otherwise used prior to its original retail purchase has been "used" for the total duration of such use. **StructurALL Warranty applies only to the following structural components listed below as installed on the product at the time of original manufacture. If a particular component is not listed below it is not covered by StructurALL Warranty.**

Arm; Articulation Joint (incl. pins & bushings); Bin Frame; Boom; Carbody; C-Frame*; Circle Frame; Coupler (John Deere built ONLY); Dipperstick; Draft Frame; Engine Frame; Equipment Frame; Grapple Arch and Grapple Boom; Loader Arm; Loader Frame; Mainframe; Moldboard Lift Arm; NeverGrease™ Pin Joints [Includes steering pin and bushing joints (standard equipment), roller elements (roller bearings) in bucket to boom joints and sliding elements (bushing) for boom and linkage joints (optional equipment)]; Rollover Protection Structure (ROPS); Side Frame; Swing Frame; Track Frame; Undercarriage Frame; X-Frame; Z-bar loader linkage (including bell crank and bucket driver link); Specialty booms and arms marketed as "heavy duty" by John Deere.

Items Covered by StructurALL for Cut-to-Length Forestry Machines: Front frame (welded assembly); Rear frame (welded assembly); Crane king post with basement; Middle joint frame; Cabin swing frame; Main Boom

StructurALL Warranty does not apply to:

1. Any product used primarily in extreme duty or severe duty applications such as but not limited to: demolition and wrecking, chemical plant (including fertilizer plants), salt mines, steel mill, land fill and transfer stations, scrap handling, scarifying and other applications that are similarly destructive or similarly heavy duty except specialty booms and arms as stated in Section D.3 above.
2. C-Frames on H-Series & J-Series Crawlers equipped with root rakes or used in forestry applications unless equipped with an "extreme duty" reinforcement package.
3. Cut-to-Length Forestry Heads and Slash Bundler Units.
4. Crawlers equipped with optional side booms.
5. Cut-to-Length Forestry, Excavator, and Log Loader swing bearings.
6. Motor Graders equipped with front- or rear-mounted snow wings.

E. ITEMS NOT COVERED -

John Deere is NOT responsible for the following:

1. Freight
2. Adjustments to compensate for wear, for periodic maintenance or adjustments that result from normal wear and tear.
3. Damage caused by unapproved adjustments (electronic or mechanical) to machine or machine components outside of published specifications including but not limited to engine, hydraulic components and relief valves.
4. Program updates, calibrations, and pressure adjustments.
5. Diagnostic Time
6. Additional Labor/Labour Time - Above SPG/Labor/Labour Rate
7. Additional Cleaning - Above SPG/Labor/Labour Rate
8. Rental Fees
9. Depreciation or damage caused by normal wear or application, lack of reasonable and proper maintenance, failure to follow operating instructions, misuse, negligence, collision or other accidents.
10. Premiums charged for Overtime Labor/Labour
11. Transportation to and from the dealership.
12. Travel time, mileage or service calls by the dealer.
13. Non-John Deere components or modifications, Rotobec grapples, and attachments installed aftermarket.
14. Shop supplies and maintenance items such as, but not limited to: filters, fuels, oil, hydraulic fluid, lubricants, coolants, conditioners, shop towels, cleaners and degreasers. Note: Reimbursement for refills of oils/coolants lost due to a warrantable failure is covered when a system failure occurs outside the boundaries of a normal oil change (within 25% of specified change interval as provided in the Operator's Manual).
15. Torn, cut, or worn hoses.
16. Wear items, such as, but not limited to: body liner, belts, blades, bulbs, lubricated joints (including pins and bushings), dry brakes, brake linings, dry clutch linings, saw blades, chains, skidder grapple shocks, color marking nozzles, and articulation bumpers.
17. Items such as cutting-edge parts, delimiting knives, bucket teeth and rubber track are not warranted for depreciation or damage caused by normal wear, lack of proper maintenance, misuse, failure to follow operating instructions, the elements or accident.
18. Any defect in a non-covered component, or damage to or failure of a covered component caused by a defect in a non-covered component.
19. Secondary damage which occurs from continued operation of a product after recognition of the occurrence of a failure.
20. Parts supplied or modifications done by third party suppliers.
21. Topping off fluids when fluid levels fall in the range between low and full
22. Parts/Kits not ordered on machine and installed aftermarket. These parts will be covered by any applicable parts warranty.
23. Attachments installed aftermarket – i.e. Winch not installed at factory.
24. Custom options installed outside the factory – i.e. G.R. Manufacturing option packages.
25. Used Products (except as otherwise provided in section L below).

F. TERMINATION OF WARRANTY-

John Deere is relieved of its obligations under Standard Warranty, StructurALL Warranty, Factory-Installed Undercarriage Warranty and/or Extended Warranty if:

1. Service (other than normal maintenance and replacement of service items) is performed by someone other than an authorized John Deere dealer; or
2. The product is modified or altered in ways not approved by John Deere; or
3. Any unapproved or improperly sized attachment is installed on the product. Approval and attachment size shall be at John Deere's sole discretion. (Consult dealer prior to installing attachments or product modification).
4. The product is moved outside the US and/or Canada.

G. PARTS REPLACED UNDER WARRANTY -

Only new or remanufactured parts or components furnished or approved by John Deere, will be used if John Deere elects to repair the product. If any such part or component is defective in material or workmanship when installed in the product, John Deere will repair or replace, as it elects, such defective part or component, provided the defect is

reported to an authorized John Deere dealer within 90 days of installation or before expiration of the applicable Standard Warranty, Factory-Installed Undercarriage Warranty and/or StructurALL Warranty whichever is later.

H. TELEMATICS

NOTICE: Products may be equipped with telematics hardware and software ("Telematics") that transmit data to John Deere/ Dealer. Purchaser may deactivate Telematics at www.jdlink.com.

Notwithstanding Purchaser's right, title or interest in the Products, Purchaser agrees that John Deere and Dealer (their affiliates, successors and assigns), without further notice to Purchaser have the right to:

1. Access, use, collect and disclose any data generated by, collected by, or stored in, Products or any hardware or devices interfacing with Products ("Machine Data");
2. Access Machine Data directly through data reporting devices integrated within, or attached to, Products, including Telematics ("Data Reporting Systems"); and
3. Update the Data Reporting Systems software from time to time. Machine Data will only be used in accordance with John Deere's Machine Data Policy, located at www.JohnDeere.com/MachineDataPolicy.

I. OBTAINING WARRANTY SERVICE -

To obtain warranty service, the purchaser must request warranty service from a John Deere dealer authorized to sell the product to be serviced. When making such a request, the purchaser must present evidence of the product's delivery date, make the product available at the dealer's place of business, and inform the dealer in what way the purchaser believes the product to be defective. Standard Warranty, Factory-Installed Undercarriage Warranty and/or StructurALL Warranty repairs may be made in the field if the purchaser and servicing dealer so desire. However, John Deere will not be responsible for any charges (such as dealer travel time, mileage or extra labor/labour) that would not have been incurred had the product been repaired at the dealer's place of business.

J. NO IMPLIED WARRANTY, CONDITIONS OR OTHER REPRESENTATION -

Where permitted by law, neither John Deere nor any company affiliated with it makes any warranties, representations, conditions or promises, express or implied, as to the quality, performance, or freedom from defect of its products, other than those set forth in this document and **NO IMPLIED WARRANTY OF MERCHANTABILITY, CONDITIONS OR FITNESS IS MADE.**

K. NO DEALER WARRANTY -

The selling dealer makes no warranty of its own on any item covered by this warranty, and makes no warranty on other items unless the dealer delivers to the purchaser a separate written warranty certificate specifically warranting the item. **The dealer has no authority to make any representation or promise on behalf of John Deere, or to modify the terms or limitations of this warranty in any way.**

L. USED JOHN DEERE PRODUCTS ONLY -

John Deere will transfer remaining Standard Warranty, Factory-Installed Undercarriage Warranty and/or StructurALL Warranty to the purchaser of a used John Deere construction and/or forestry product that has been used for less than the full warranty period provided at the product's original retail purchase. This transfer is not effective until change of ownership is registered by a John Deere dealer. **ALL THE TERMS, INCLUDING LIMITATIONS AND EXCLUSIONS, OF THE JOHN DEERE STANDARD WARRANTY, FACTORY-INSTALLED UNDERCARRIAGE WARRANTY, AND/OR STRUCTURALL WARRANTY ORIGINALLY PROVIDED FOR THE PRODUCT REMAIN IN EFFECT AND APPLICABLE.**



APR 7-29-20

7910

PO 20-002397

Advance Lease Payment Invoice

Due Date:	07/28/2020
Total Due:	\$18,506.41

Billing Address:	Updated Billing Information:
CITY OF FLINT PO BOX 246 FLINT, MI 48501-0246	

Please Note: All future invoices will be sent to the billing address shown unless you update your billing information above.

Master Lease Agreement Number	0063090
-------------------------------	---------

App #	Mfg.	Model #	Serial Number	Due Date	Rental/Tax Amount	Security Deposit	Origination Fee	Advance Lease Payment
218240	JD	410L	1T0410LXHFL386 242	07/28/2020	\$18,506.41	\$0.00	\$0.00	\$18,506.41

Correspondence Only:	Remit Checks Payable To:
Deere Credit, Inc. Attn: Lease Administration PO Box 6600 Johnston, IA 50131-6600 Phone: (800) 771-0681 – select "lease" prompt Fax: (800) 254-0020 Lease issues only	Deere Credit, Inc. Attn: Acct. Dept. – ALP Processing PO Box 6600 Johnston, IA 50131-6600

TO ENSURE PROPER CREDIT, STAPLE CHECK AND RETURN THIS INVOICE WITH THE LEASE DOCUMENTS.

STAPLE ADVANCE LEASE PAYMENT CHECK HERE

Every Dishonored Check will result in a fee of \$20.00 or an amount not to exceed the highest amount permitted by law.

THIS MULTITONE AREA OF THE DOCUMENT CHANGES COLOR GRADUALLY AND EVENLY FROM DARK TO LIGHT WITH DARKER AREAS BOTH TOP AND BOTTOM



JP Morgan Chase
Flint, MI 48502-1650

CITY OF FLINT
COMMERCIAL ACCOUNT 74-1292/724
FLINT MI 48502

00000186245
07/31/2020

Pay This Amount \$18,506.40 ***

Void After 90 Days

EIGHTEEN THOUSAND FIVE HUNDRED SIX AND 40/100 DOLLARS**

Pay AIS CONSTRUCTION EQUIP&CONTRACTORS
To The OR DEERE CREDIT
Order Of PO BOX 6600
JOHNSTON IA 50131-6600

Amanda Trujillo
CITY TREASURER

⑈0186245⑈

⑆072000326⑆

937809507⑈

THE ORIGINAL DOCUMENT HAS A REFLECTIVE WATERMARK ON THE BACK. HOLD AT AN ANGLE TO VIEW WHEN CHECKING THE ENDORSEMENT.

Vendor ID 000000003
AIS CONSTRUCTION EQUIP&CONTRACTORS
OR DEERE CREDIT
PO BOX 6600
JOHNSTON IA 50131-6600

CITY OF FLINT
1101 S SAGINAW ST
FLINT MI 48502

Check Date: 07/31/2020

Check No 00000186245

HC	Invoice Number	Invoice Dat	Voucher ID	Gross Amount	Discount Available	Paid Amount
JD	0063090 APP#218240	07/28/2020	388817	18,506.40		18,506.40

Check Numbe	Date	Total Amount	Late Interest	Discounts Taken	Total Paid Amount
00000186245	07/31/2020	18,506.40		0.00	18,506.40

For Accounts Payable Information: Phone (810) 766-7263



JOHN DEERE FINANCIAL

Lease Schedule

Lease Schedule No.	030-0063090-017
Master Lease Agreement No.	0063090

Lessee: (Name & Address)	CITY OF FLINT 1101 S SAGINAW ST, FLINT, MI 48502-1420
Lessor:	DEERE CREDIT, INC. 6400 NW 86 th ST, PO BOX 6600, JOHNSTON, IA 50131-6600

LEASE TERM

Lease Term Start Date	Lease Term End Date	# Of Payments	Lease Payment	*Sales/Use Tax	Total Lease Payment	Purchase Option Price
07/28/2020	07/28/2025	5	\$18,506.41	\$0.00	\$18,506.41	\$54,526.00

*If part of the regular scheduled lease payment

RENEWAL TERM

Renewal Term Start Date	Renewal Term End Date	# Of Payments	Renewal Lease Payment Amount	Sales/Use Tax	Total Renewal Lease Payment	Purchase Option Price

PAYMENT TERMS

PAYMENT DUE AT SIGNING

Due Date	1 st Payment Due Date	Discount Rate	Advance Lease Payment**	\$18,506.41
28	07/28/2020	Internal Rate of Return minus 2 percent (2%)	Origination Fee	\$0.00
Billing Period	Irregular Payments		Security Deposit	\$0.00
<input type="checkbox"/> Monthly <input type="checkbox"/> Quarterly <input type="checkbox"/> Semi-Annual <input checked="" type="checkbox"/> Annual <input type="checkbox"/> Irregular			Total Due At Signing	\$18,506.41
**Advance Lease Payment includes the first (1) and last (0) Lease Payment(s)				

"Master Agreement" shall mean the above referenced Master Lease Agreement. "Schedule" shall mean this Lease Schedule. "Lease" shall mean this Schedule and the Master Agreement. All of the terms and conditions set forth in the Master Agreement and any amendment, addendum, schedule or attachment thereto or hereto including, but not limited to, the Equipment Return Provisions are hereby incorporated into and made a part of this Schedule.

Lease Payments. You agree to remit the Lease Payments (and applicable sales, use and property taxes) on the dates noted above and all other amounts when due to: DEERE CREDIT, INC., P.O. Box 4450, Carol Stream, IL 60197-4450.

Hourly Charges. You certify that the engine hour meter reading on each item of Equipment is accurate as of the date you sign this Schedule. If you use any Equipment during the Lease Term for more than the Engine Hourly Limit indicated above for that item of Equipment, you will pay to us within 10 days of the Lease Term End Date (or any earlier termination of the Lease) an amount equal to the Excess Hour Charge for that item of Equipment for each engine hour in excess of the Engine Hourly Limit. If the Lease is terminated, cancelled or extended for any reason, the Hourly Limit will be prorated by us in our sole discretion.

Purchase Option. You may purchase the Equipment on the Lease Term End Date (or the Renewal Term End Date) for the applicable Purchase Option Price (plus applicable Taxes including estimated property taxes), provided (1) you are not in default; and (2) we receive the Purchase Option Price and any other amounts you owe us on or before the Lease Term End Date (or the Renewal Term End Date). Upon receipt of the Purchase Option Price, we will transfer to you all of our right, title and interest in such item(s) of Equipment AS-IS, WHERE-IS, WITHOUT ANY WARRANTY AS TO CONDITION OR VALUE.

Renewal Term. If (1) a Renewal Term is provided for above, and (2) you notify us at least sixty (60) days prior to the end of the Lease Term that you intend to renew the Lease for the Renewal Term, the Lease shall renew for the Renewal Term. You agree to remit to us the Renewal Lease Payments indicated above (plus applicable taxes and other amounts) when due and payable each Billing Period, even if we do not send you a bill or an invoice.

Representations and Warranties. You represent and warrant to us, as of the date you signed this Schedule, that (1) the Equipment was selected by you; (2) the Equipment (including all manufacturer manuals and instructions) has been delivered to, and examined by, you; (3) the safe operation and the proper servicing of the Equipment were explained to you; (4) you received the written warranty applicable to the Equipment and understand that your rights under the written warranty may be limited; (5) the Equipment is unconditionally and irrevocably accepted by you as being suitable for its intended use; (6) the Equipment is in good condition and repair (operating and otherwise); (7) the Equipment shall be used only for the purpose indicated herein; (8) except as disclosed to us, neither you nor any person related to you will have an equity interest in the Equipment on the Lease Term Start Date; and (9) all information provided to us by you is true and correct.

You acknowledge and agree that: (1) we did not select, manufacture or supply any of the Equipment; (2) we acquired the Equipment at your direction; (3) you selected the supplier of the Equipment; (4) you are entitled to all manufacturer warranties ("Warranty Rights") and we assign all Warranty Rights to you, to the extent assignable; (5) you may request an accurate and complete statement of the Warranty Rights, including any disclaimers and limitations, directly from the manufacturer; and (6) you assign to us all your rights (but none of your obligations) under all purchase orders, purchase agreements or similar documents relating to the Equipment. You waive all rights and remedies conferred upon a lessee under Sections 506 - 522 of Article 2A of the Uniform Commercial Code.

Lease Payments may be based on the assumption that we will be entitled to certain tax benefits as the owner of the Equipment. If you take or fail to take any action that results in a loss of such tax benefits, you will pay us, on demand, the amount we calculate as the value of such lost tax benefits.

Miscellaneous. You agree that we can access any information regarding the location, maintenance, operation and condition of the Equipment, and you irrevocably authorize anyone in possession of such information to provide all of that information to us upon our request. You also agree to not disable or otherwise interfere with any information-gathering or transmission device within or attached to the Equipment. You permit us to monitor and record telephone conversations between you and us. By providing any telephone number, including a mobile phone number, to us, any of our affiliates or any debt collectors we retain, we, such affiliates and such retained debt collectors can contact you using that number, including calls using an automatic dialing and announcing device and prerecorded calls, and that such calls are not "unsolicited" under state or federal law. All of our rights under each Lease shall remain in effect after the expiration of the Lease Term or termination of the Schedule.

You acknowledge and agree that, if You execute this Lease Agreement with your electronic signature, (a) you are signifying your intent to enter into this Lease Agreement and that this Lease Agreement be legally valid and enforceable in accordance with its terms to the same extent as if you had executed this Lease Agreement using your written signature, and (b) this Lease Agreement is an electronic record executed by you using your electronic signature. You agree that unless the authoritative electronic copy of this Lease Agreement ("Authoritative Copy") is converted to paper and marked as the original by us (the "Paper Contract"), the Authoritative Copy shall at all times reside in a document management system designated by us for the storage of authoritative copies of electronic records (the "DMS"), and shall be deemed held in the ordinary course of business. In the event the Authoritative Copy is converted to a Paper Contract, you acknowledge and agree that (1) your signing of this Lease Agreement also constitutes issuance and delivery of such Paper Contract, (2) your electronic signature associated with this Lease Agreement, when affixed to the Paper Contract, constitutes your legally valid and binding signature on the Paper Contract, and (3) your obligations will be evidenced by the Paper Contract alone after such conversion.

Lease Schedule – Equipment List

Supplier <small>(Name & Address)</small>	AIS CONSTRUCTION EQUIPMENT 600 44TH STREET SW, GRAND RAPIDS, MI 49548
--	---

EQUIPMENT INFORMATION

Year	Make	Equipment Description	Serial Number	Engine Hour Meter	Engine Hour Limit	Excess Hour Charge	Payment	Purchase Option
2020	JD	410L BACKHOE LOADER	1T0410LXHLF386242	1	1000/YR	\$25.00/HR	\$18,506.41	\$54,528.00

Equipment Location	1101 S SAGINAW ST, FLINT, MI, 48502-1420	OUTSIDE city limits: <input type="checkbox"/>	GENESEE COUNTY
---------------------------	--	---	----------------

BY SIGNING THIS SCHEDULE, YOU AGREE TO ALL OF THE TERMS AND CONDITIONS OF THIS SCHEDULE AND THE MASTER AGREEMENT.

LESSEE
CITY OF FLINT
 1101 S SAGINAW ST
 FLINT, MI 48502-1420

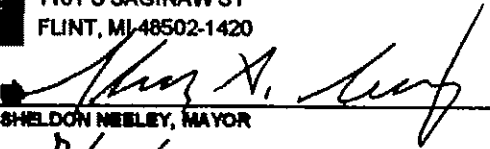
By: 
 SHELDON NEELEY, MAYOR

Date: 7/30/20

LESSOR
DEERE CREDIT, INC.
 6400 NW 86th ST, PO BOX 6600
 JOHNSTON, IA 50131-6600

By: _____

Date: _____



Equipment Return Provisions

Lease Schedule No.	030-0063090-017
Master Lease Agreement No.	0063090

Lessee: (Name & Address)	CITY OF FLINT 1101 S SAGINAW ST, FLINT, MI 48502-1420
Lessor:	DEERE CREDIT, INC. 6400 NW 86 th ST, PO BOX 6600, JOHNSTON, IA 50131-6600

The following Equipment Return Provisions are hereby incorporated into and made a part of the above referenced Master Lease Agreement (the "Master Agreement"), and entered into between Deere Credit, Inc., as Lessor ("us", "we" or "our"), and CITY OF FLINT, as Lessee ("you" or "your"). Pursuant to Section 9 of the Master Lease Agreement, all Equipment must be returned to us in satisfactory condition. Unsatisfactory condition shall include any condition described in Sections 1 through 4 below ("Excessive Wear and Tear").

1. **Mechanical.**
 - A. Computer systems or safety and emission control equipment not in proper working order.
 - B. Mechanical components that are missing, broken or unsafe or that do not operate normally, other than normal tune-ups, given the age of the equipment.
 - C. Wear on power train assembly that exceeds manufacturer's then current standards for normal wear and tear.
 - D. Any air filters not within manufacturer's specifications.
 - E. Any gauges or fluid indicators that are damaged or do not function, the electrical system fails to operate properly, the battery fails to hold a charge or any wire harnesses that are not tied down and kept secured, dry and clean.
 - F. Any pumps, motors, valves or cylinders not in good operating condition or that fail to meet manufacturer's rated specifications or hydraulic system exceeds manufacturer's then-current contaminant standards (as shown by oil sample analysis). Equipment not serviced according to the manufacturer's operating manual.
 - G. Any lubricant, water or A/C seal leaks.
2. **Exterior.**
 - A. Dents larger than 2 inches in diameter.
 - B. Excessive number of dents or scratches.
 - C. Any scratch 8" or longer that reaches the metal skin.
 - D. Any single chip the size of a quarter or larger or multiple small chips within one square foot.
 - E. Substandard paint repairs, such as peeling, bubbling or mismatched shades that evidence poor condition in comparison with original paint and require repainting at a cost in excess of \$200.
 - F. Rust holes in the body metal or a rust spot that covers more than a 4-inch square area.
 - G. Any glass that must be replaced due to cracks or missing glass and any windshield damages greater than \$50 in amount.
 - H. All frame damage and substandard frame repairs.
 - I. Any tires or tracks that (a) have broken side walls or excessive cuts or damages, or (b) have less than 50% of the original useful life remaining, or (c) are not of the same size, type grade or equivalent quality manufacturer as were originally included on the Equipment.
3. **Cab/Operator Platform.**
 - A. Heavy interior soil or strong odors, such as manure, that cannot be removed by general cleaning.
 - B. Unclean condition of operator environment.
 - C. Holes, tears, or burns on the dash, floor covers, seats, headliners, upholstery or interior.
4. **General.**
 - A. Equipment not operated or maintained in accordance with the manufacturer's specifications or if components, fuels or fluids, on or in connection with the Equipment that do not meet manufacturer's standards were used.
 - B. Any other damage that in the aggregate costs \$250 or more to repair or that makes the Equipment unlawful or unsafe to operate.
5. **Other.**
 - A. All warranty and PIP work must be completed prior to the Lease Term End Date of the Lease Schedule relating to the Equipment.
 - B. The Equipment must be cleaned prior to its return.
 - C. The Equipment must be prepared for storage according to the operators manual, including flushing the system and use of winterization fluid.
6. **Hour Meter.** For each item of Equipment returned with a broken or missing hour meter, you shall accept an invoice from us and remit to us an amount equal to \$1,000. You agree that the hour meter included with the Equipment is conclusive of the number of hours of Equipment use.
7. **Invoices for Excess Wear And Tear.** Upon any return of the Equipment, we shall, in our sole discretion, determine the existence of any Excessive Wear and Tear. In the event any item of Equipment is returned to us with Excessive Wear and Tear, you shall, at our sole discretion, either (I) accept an invoice from us and remit to us the cost of repairing or replacing the affected component(s) which we determine necessary to return the Equipment to its required condition, and/or (II) accept an invoice from us and remit to us an amount equal to our estimate of (1) the cost of new tires or tracks if the tires or tracks are damaged due to broken side walls or excessive cuts or damage, or (2) the cost of new tires or tracks multiplied by the difference between (A) our estimate of the percentage of the useful life of the tires and tracks then remaining, and (B) fifty percent (50%). For example, if you return Equipment with tires having 20% of their useful life remaining, you would remit to us an amount equal to 30% of the cost of new tires ((50% - 20%) multiplied by the cost of new tires). Your failure to remit the required payment to us within ten (10) days of demand shall constitute a default by you under the terms of the Lease.

LESSEE	CITY OF FLINT 1101 S SAGINAW ST FLINT, MI 48502-1420
By:	_____
	SHELDON NEELEY, MAYOR
Date:	_____

LESSOR	DEERE CREDIT, INC. 6400 NW 86 th ST, PO BOX 6600 JOHNSTON, IA 50131-6600
By: _____	_____
Date: _____	_____



Delivery and Acknowledgment

Lease Schedule No.	030-0063090-017
Master Lease Agreement No.	0063090

Lessee: <small>(Name & Address)</small>	CITY OF FLINT 1101 S SAGINAW ST, FLINT, MI 48502-1420
Lessor:	DEERE CREDIT, INC. 6400 NW 86 th ST, PO BOX 6600, JOHNSTON, IA 50131-6600

Capitalized terms shall have the meanings set forth in the above referenced Master Lease Agreement.

Lessee hereby represents and warrants that: (1) all of the Equipment more fully described in the above referenced Lease Schedule was selected by Lessee; (2) all of the Equipment and the Operator's Manuals have been delivered to, and received by, Lessee; (3) all of the Equipment has been inspected by Lessee and is in good working order; (4) all of the Equipment is unconditionally and irrevocably accepted by Lessee for all purposes under the Lease; (5) the safe operation and the proper servicing of the Equipment have been explained to Lessee; (6) Lessee received the manufacturer's written warranty applicable to the Equipment and Lessee understands that its rights are subject to the limitations outlined therein; (7) no Event of Default has occurred and is continuing; and (8) no material adverse change in the financial or business condition of Lessee has occurred since the date of the last financial statement submitted to Lessor by Lessee.

Signed by Lessee's duly authorized representative on the date shown below.

LESSEE	CITY OF FLINT 1101 S SAGINAW ST FLINT, MI 48502-1420
By:	_____
	SHELDON NEELEY, MAYOR
Date:	_____
	7/30/00

LESSOR	DEERE CREDIT, INC. 6400 N.W.86 th STREET, PO BOX 6600 JOHNSTON, IA 50131-6600
By: _____	
Date: _____	



Property Tax Acknowledgment

Lease Schedule No.	030-0063090-017
Master Lease Agreement No.	0063090

Lessee: (Name & Address)	CITY OF FLINT 1101 S SAGINAW ST, FLINT, MI 48502-1420
Lessor:	DEERE CREDIT, INC. 6400 NW 86 th ST, PO BOX 6600, JOHNSTON, IA 50131-6600

As Lessor and Owner of the equipment, Deere Credit, Inc. is responsible for filing and paying property tax to the appropriate taxing authority. Lessee should not report this equipment on their property tax return.

Lessor will bill Lessee for property taxes upon receipt of an assessment from the taxing authority. Lessee will reimburse Lessor for property taxes upon receipt of an invoice from John Deere Financial. Please refer to section 3 of the Master Lease Agreement for further information.

The equipment listed on the attached Master Lease Schedule – Equipment List will be reported to the following taxing jurisdiction(s).

1101 S SAGINAW ST Check here if OUTSIDE city limits
 Street Address
 FLINT MI 48502-1420 GENESEE
 City State Zip County

PLEASE VALIDATE THE ABOVE INFORMATION & MAKE APPLICABLE CHANGES BELOW:

Street Address Check here if OUTSIDE city limits
 City State Zip County

Check here if Sales/Use Tax Exempt Check here if Property Tax Exempt

Equipment Usage:	
Percentage of Time:	

The undersigned (the "Lessee") acknowledges that they have verified the equipment location listed above; understands that the Lessor will file and pay property taxes and that the Lessee is required to reimburse Lessor upon receipt of an invoice for property taxes. Failure to reimburse Lessor for property taxes shall constitute an Event of Default as described in Section 10 of the Lease.

LESSEE CITY OF FLINT
 1101 S SAGINAW ST
 FLINT, MI 48502-1420

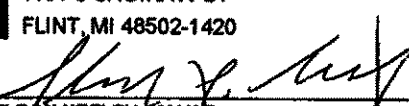
By: 
 SHELDON NEELEY, MAYOR

Date: 7/30/20



**JOHN DEERE
FINANCIAL**

Physical Damage/Liability Insurance

Lease Schedule No.	030-0063090-017
Master Lease Agreement No.	0063090

Lessee: (Name & Address)	CITY OF FLINT 1101 S SAGINAW ST, FLINT, MI 48502-1420
Lessor:	DEERE CREDIT, INC. 6400 NW 86 th ST, PO BOX 6600, JOHNSTON, IA 50131-6600

LIABILITY INSURANCE on the above referenced Lease Schedule (the "Schedule") to the above referenced Master Lease Agreement will be provided by the following insurance agency:

Name of Agency:	Phone Number of Agency:
Mailing Address of Agency	Fax Number of Agency

PHYSICAL DAMAGE INSURANCE on the Schedule will be provided by the following agency:

Name of Agency:	Phone Number of Agency:
Mailing Address of Agency	Fax Number of Agency

If an insurance certificate is available, it should be provided in place of the above information

ADDITIONAL INSURED and LOSS PAYEE:

Deere Credit, Inc.
Its Successors &/or Assigns
6400 NW 86th St
Johnston, IA 50131

The undersigned agrees and understands that, pursuant to the provisions of Section 6 of the Master Lease Agreement, the undersigned must at all times (1) maintain public liability insurance, covering personal injury and property damage for not less than \$1,000,000 per occurrence, naming us (and our successors and assigns) as additional insured; and (2) keep the Equipment insured against all risks of physical damage for no less than its Termination Value (as such term is defined in Section 7 of the Master Lease Agreement), naming us (and our successors and assigns) as sole loss payee.

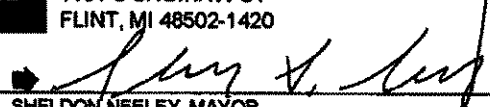
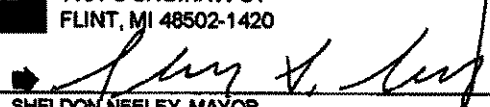
LESSEE	CITY OF FLINT 1101 S SAGINAW ST FLINT, MI 48502-1420
By: 	
Date: 	

Office Use Only

Contact Date(s):	Contact Name:
Liability Insurance Company Policy #:	Liability Insurance Expiration Date
Liability Limits:	Notes:
Physical Damage Insurance Company and Policy #	Physical Damage Insurance Expiration Date
Insured Value:	Notes:
Loss Payee Deere Credit, Inc.? <input type="checkbox"/> Yes <input type="checkbox"/> W/M Be Added	Verified By:



Advance Lease Payment Invoice

Due Date:	07/28/2020
Total Due:	\$18,506.41

Billing Address:	Updated Billing Information:
CITY OF FLINT PO BOX 246 FLINT, MI 48501-0246	

Please Note: All future invoices will be sent to the billing address shown unless you update your billing information above.

Master Lease Agreement Number		0063090						
App #	Mfg.	Model #	Serial Number	Due Date	Rental/Tax Amount	Security Deposit	Origination Fee	Advance Lease Payment
218240	JD	410L	1T0410LXHLF386 242	07/28/2020	\$18,506.41	\$0.00	\$0.00	\$18,506.41

Correspondence Only:	Remit Checks Payable To:
Deere Credit, Inc. Attn: Lease Administration PO Box 6600 Johnston, IA 50131-6600 Phone: (800) 771-0681 – select "lease" prompt Fax: (800) 254-0020 Lease issues only	Deere Credit, Inc. Attn: Acct. Dept. – ALP Processing PO Box 6600 Johnston, IA 50131-6600

TO ENSURE PROPER CREDIT, STAPLE CHECK AND RETURN THIS INVOICE WITH THE LEASE DOCUMENTS.

STAPLE ADVANCE LEASE PAYMENT CHECK HERE

Every Dishonored Check will result in a fee of \$20.00 or an amount not to exceed the highest amount permitted by law.

John Deere Financial Direct Pay-Recurring Enrollment

For Credit Card accounts and Installment Loans

Fax 800-826-9527

Or Mail: John Deere Financial, Attn: Payment Specialist, PO Box 5327, Madison, WI 53705

Lease

Fax to 800-254-0020

Or Mail: John Deere Financial, Attn: Lease Dept, PO Box 6600, Johnston, IA 50131-6600

Eligibility

Your account with John Deere Financial must be **current** in order to enroll for the Direct-Pay Recurring payment option. Your account with your financial institution must allow automatic withdrawals.

How to Enroll

Complete and sign the authorization form below. Please be sure to provide all information requested.

Bank & account information, whether it is a saving or checking account. For the typical checking accounts, the account information is located similar to the sample business or personal checks below:

Sample Personal Check

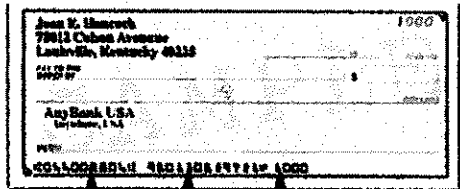

↑ Routing & Transit Number ↑ Checking Acct Number ↑ Check Number

Sample Business Check

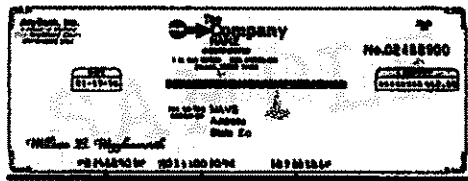

↑ Check Number ↑ Routing & Transit Number ↑ Checking Acct Number

JOHN DEERE FINANCIAL DIRECT PAY-RECURRING AUTHORIZATION FORM

My signature below authorizes Deere Credit Services, Inc. and its affiliates, (the Company), to initiate debit entries to the checking/savings account below for the regularly scheduled payments or other amounts that I may owe the Company. This authorization is to remain in full force and effect until canceled by the Company, or by written notification from me, given in such time and manner as to allow the Company a reasonable opportunity to act upon it.

If your account is closed due to an Add-On transaction, consolidation or corrected loan agreement and you have Direct Pay-Recurring, your enrollment and banking information will be transferred to your new account.

Bank Name

John Deere Financial Account Number

Bank City & State

Name on John Deere Financial Account

Name on Bank Account

Social Security Number/Federal Tax ID

9 digit Bank Routing and Transit #

Type of Account: Checking Savings

Bank Account Number

I request Direct Pay Recurring to begin with my payment due ____ / ____ / ____

I understand any payment due prior to the month I requested above, must be made in order to be eligible for Direct Pay Recurring.

Bank Account Owner Signature Date

Bank Account Owner Phone Number

Claim for Exemption of State and Local Sales/Use Tax for Municipal and Tribal Entities

Seller

Name: Deere Credit Inc.

Address: 6400 NW 86th St. Johnston, IA 50131

Purchaser

Name: CITY OF FLINT

Address: 1101 S SAGINAW ST, FLINT, MI 48502-1420

ID Number (If Applicable): _____

Exemption Number (if applicable): _____

Description of Item Being Purchased

Quantity	Year	Make	Model	Equipment Description
1	2020	JD	410L	BACKHOE LOADER

By signing below, purchaser certifies that the items being purchased are exempt from state and local sales tax.

By: _____

Title: _____

Date: _____

Telephone Number: _____

Version 2 updated March 27 2018



JOHN DEERE FINANCIAL

Master Lease Agreement

Agreement No. 0063090

Lessee:	CITY OF FLINT 1101 S SAGINAW ST., FLINT, MI 48502-1420
Lessor:	DEERE CREDIT, INC. 6400 NW 86 TH ST, PO BOX 6600, JOHNSTON, IA 50131-6600
This Master Lease Agreement ("Master Agreement") is entered into between Deere Credit, Inc., as Lessor ("we", "us" or "our"), and the Lessee and any Co-Lessee identified below ("you" or "your"). "Schedule" shall mean any Lease Schedule signed by you and us, which incorporates the terms of this Master Agreement. "Lease" shall mean this Master Agreement and any Schedule.	

TERMS AND CONDITIONS

- Lease Term; Payments.** You agree to lease from us the property ("Equipment") described in each Schedule for the Lease Term. The Lease Term will begin on the Lease Term Start Date and end on the Lease Term End Date. All attachments and accessories itemized on the Schedule and all replacements, parts and repairs to the Equipment shall form part of the Equipment. A Schedule is not accepted by us until we sign it, even if you have made a payment to us. You agree to remit to us the Lease Payments indicated in the Schedule and all other amounts when due and payable each Billing Period, even if we do not send you a bill or an invoice. **YOUR PAYMENT OBLIGATIONS ARE ABSOLUTE AND UNCONDITIONAL, AND ARE NOT SUBJECT TO CANCELLATION, REDUCTION OR SETOFF FOR ANY REASON WHATSOEVER.** For any payment which is not received by its due date, you agree to pay a late charge equal to 5% of the past due amount (not to exceed the maximum amount permitted by law) as reasonable collection costs, plus interest from the due date until paid at a rate of 1.5% per month, but in no event more than the maximum lawful rate. Restrictive endorsements on checks you send us will not change or reduce your obligations to us. If a payment is returned to us by the bank for any reason, you agree to pay us a fee of \$25.00, or the maximum amount permitted by law, whichever is less. Lease Payments and other payments may be applied, at our discretion, to any obligation you may have to us or any of our affiliates. If the total of all payments made during the Lease Term (and any Renewal Term), exceeds the total of all amounts due under the Lease by less than \$25.00, we may retain such excess.
- Security Deposit.** If the Schedule provides for a Security Deposit, the Security Deposit will be held by us in a non-interest bearing account, commingled with other funds. We may apply the Security Deposit to any amounts due under the Lease and, if we do so, you agree to promptly remit to us the amount necessary to restore the Security Deposit to the original amount. The Security Deposit will be returned to you within thirty days of termination of a Schedule and final inspection by us, provided you are not in default.
- Taxes.** Although you may be exempt from the payment of Certain Taxes, you agree to pay us when invoiced (a) all sales, use, rental, gross receipts and all other taxes which may be imposed on the Equipment or its use, and (b) all taxes and governmental charges associated with the ownership, use or possession of the Equipment including, but not limited to, personal property and ad valorem taxes ("Taxes"). Taxes do not include those measured by our net income. If applicable law requires tax returns or reports to be filed by you, you agree to promptly file such tax return and reports and deliver copies to us. You agree to keep and make available to us all tax returns and reports for Taxes paid by you.
- Security Interest; Missing Information.** We are the owner of the Equipment and you have the right to use the Equipment under the terms of the Lease. If a Schedule is deemed to be a secured transaction and not a lease, you (a) grant us and our affiliates a security interest in the Equipment (and all proceeds) to secure all of your obligations under the Lease and any other obligations, which you may have, to us or any of our affiliates, and (b) authorize us to file financing statements naming you as debtor. You agree to keep the Equipment free and clear of liens and encumbrances, except those in our favor, and promptly notify us if a lien or encumbrance is placed or threatened against the Equipment. You irrevocably authorize us, at any time, to (a) insert or correct information on the Lease, including your correct legal name, serial numbers and Equipment descriptions; (b) submit notices and proofs of loss for any required insurance; and (c) endorse your name on remittances for insurance and Equipment sale or lease proceeds. Notwithstanding any other election you make, you agree that (1) we can access any information regarding the location, maintenance, operation and condition of the Equipment, (2) you irrevocably authorize anyone in possession of that information to provide all of that information to us upon our request; (3) you will not disable or otherwise interfere with any information gathering or transmission device within or attached to the Equipment; and (4) we may reactivate any such device.
- Equipment Maintenance, Operation and Use.** You agree to (a) USE THE EQUIPMENT ONLY FOR AGRICULTURAL, BUSINESS OR COMMERCIAL PURPOSES AND NOT FOR PERSONAL, FAMILY OR HOUSEHOLD PURPOSES; (b) not move the Equipment to another county or state without notifying us within 30 days; (c) operate and maintain the Equipment in accordance with all (1) laws, ordinances and regulations, (2) manuals and other instructions issued by the manufacturer(s) and supplier(s), and (3) insurance policy terms and requirements; (d) perform (at your own expense) all maintenance and repairs necessary to keep the Equipment in as good a condition as when delivered to you, reasonable wear excepted; (e) not install any accessory or device on the Equipment which affects the value, useful life or the originally intended function or use of the Equipment in any way, unless it can be removed without damaging the Equipment; (f) allow us and our agent(s) to inspect the Equipment and all of your records related to its use, maintenance and repair, at any reasonable time; (g) keep any metering device installed on the Equipment connected and in good working condition at all times; (h) affix and maintain, in a prominent place on the Equipment, any labels, plates or other markings we may provide to you; and (i) not permit the Equipment to be used by, or to be in the possession of, anyone other than you or your employees.
- Insurance.** You agree, at your cost, to (a) keep the Equipment insured against all risks of physical damage for no less than its Termination Value (as such term is defined in Section 7 below), naming us (and our successors and assigns) as sole loss payee; and (b) maintain public liability insurance, covering personal injury and property damage for not less than \$1,000,000 per occurrence, naming us (and our successors and assigns) as additional insured. All insurance must be with companies and policies acceptable to us. Your obligation to insure the Equipment continues until you return the Equipment to us and we accept it. Each insurance policy must provide that (a) our interest in the policy will not be invalidated by any act, omission, breach or neglect of anyone other than us; and (b) the insurer will give us at least 30 days' prior written notice before any cancellation of, or material change to, the policy.
Unless you provide us with evidence of the required insurance coverages, we may purchase insurance, at your expense, to protect our interests in the Equipment. This insurance may not (1) protect your interests; or (2) pay any claim that you make or any claim that is made against you in connection with the Equipment. You may later cancel any insurance purchased by us, but only after providing us with evidence that you have obtained the insurance required by the Lease. The cost of the insurance may be more than the cost of insurance you may be able to obtain on your own.
- Loss or Damage.** Until the Equipment is returned to us in satisfactory condition, you are responsible for all risk of loss, damage, theft, destruction or seizure of the Equipment (an "Event of Loss"). You must promptly notify us of any Event of Loss. If the Equipment can be repaired or replaced, you agree to promptly repair or replace the Equipment, at your cost, and the terms of the Lease will continue to apply. If the Equipment cannot be repaired or replaced, you agree to pay us, within 10 days of the Event of Loss, its Termination Value as of the day before such Event of Loss occurred. Upon receipt of the Termination Value, we will transfer to you (or the insurance company) all of our right, title and interest in such item(s) of Equipment (each, an "Item") AS-IS, WHERE-IS, WITHOUT ANY WARRANTY AS TO CONDITION OR VALUE. All insurance proceeds must be paid directly to us, and we may apply any excess insurance proceeds to any other amounts you owe us or any of our affiliates. "Termination Value" for any Item shall be the net book value calculated as the sum of (1) all Lease Payments and any other amounts then due and payable to us; plus (2) the present value of all remaining Lease Payments and other amounts, discounted at the Internal Rate of Return or, if a discount rate is set forth in the applicable Schedule, such discount rate (the "Discount Rate"); plus (3) the cost to repair and refurbish the Item so that it is in satisfactory condition in accordance with Section 9; plus (4) the present value of the Purchase Option Price (or, if there is no Purchase Option Price, the residual value that we assumed in calculating Lease Payments), discounted at the Discount Rate. "Internal Rate of Return" shall be calculated using standard finance techniques with the Equipment Cost, Lease Payments, Lease Term and Purchase Option Price (or residual value assumption) as the variables.

ADDITIONAL TERMS AND CONDITIONS OF MASTER LEASE AGREEMENT

8. **Early Payoff/Purchase.** In the event you desire to purchase an item of Equipment, are not in default, and request a termination of a Schedule before the expiration of its Lease Term, you agree to pay us the Termination Value for each item of Equipment. Upon receipt of the Termination Value, we will transfer to you all of our right, title and interest in such item of Equipment.
9. **Return of Equipment.** If a Schedule is terminated for any reason and you do not (a) return the Equipment to us, (b) exercise any Purchase Option, or (c) exercise any Renewal Option, you agree to remit to us, until such time as the Equipment is returned to us in accordance with the provisions of this Section, lease payments each month equal to the higher of (i) the monthly fair market rental value of the Equipment, as determined by us in our sole discretion, or (ii) the monthly Lease Payment set forth in the Schedule (or the monthly lease payment equivalent if the Lease Payments are other than monthly (e.g., for annual Lease Payments, the monthly lease payment equivalent would be calculated by dividing the annual Lease Payment by 12)). All Equipment must be returned to the nearest John Deere dealer that sells equipment substantially similar to the Equipment, at your expense and in satisfactory condition, along with all use, maintenance and repair records. Equipment is in satisfactory condition if it is in as good a condition as when the Equipment was delivered to you, reasonable wear excepted, and conforms to the standards of any Equipment Return Provisions incorporated into the Lease.
10. **Default.** You will be in default if: (a) you fail to remit to us any Lease Payment or other payment when due; (b) you breach any other provision of the Lease and fail to cure such breach within 10 days; (c) you remove any Equipment from the United States; (d) a petition is filed by or against you or any guarantor under any bankruptcy or insolvency law; (e) a default occurs under any other agreement between you (or any of your affiliates) and us (or any of our affiliates); (f) you or any guarantor is acquired by, merges with or consolidates into another entity, sells substantially all its assets, dissolves or terminates its existence, or (if an individual) dies; or (g) you fail to maintain the insurance required by Section 6. Time is of the essence under the Lease.
11. **Remedies.** If a default occurs, we may, to extent permitted by applicable law, do one or more of the following: (a) require you to return the Equipment in the manner outlined in Section 9, or take possession of the Equipment; (b) recover from you, AS LIQUIDATED DAMAGES FOR LOSS OF BARGAIN AND NOT AS A PENALTY (i) if the Equipment is returned and the Lease is deemed to be a lease and not a secured transaction in our sole discretion, the sum of (1) all Lease Payments and any other amounts then due and payable to us; (2) the present value of all remaining Lease Payments and other amounts, discounted at the Discount Rate; (3) the cost to repair and refurbish the item of Equipment so that it is in satisfactory condition in accordance with Section 9 and (4) unamortized amount of our initial direct costs of originating and administering the applicable Schedule (ii) if the Equipment is returned to us and the Lease is deemed to be a secured transaction and not a lease in our sole discretion, the difference between (1) the Termination Value as of the date of such default; and (2) the net proceeds we receive from any sale, lease or other disposition of the Equipment (after deducting all of our costs and expenses) or (iii) if the Equipment is not returned to us, the Termination Value as of the date of such default; (c) declare any other agreements between you and us (or any of our affiliates) in default; (d) terminate any of your rights (but none of your obligations) under any Lease and any other agreement between you and us (or any of our affiliates); (e) charge you for the expenses incurred in connection with the enforcement of our remedies including, without limitation, repossession, repair and collection costs, attorneys' fees and court costs; (f) exercise any other remedy available at law or in equity; and (g) take on your behalf (at your expense) any action required by the Lease which you fail to take. These remedies are cumulative, are in addition to any other remedies provided by law, and may be exercised concurrently or separately. Any failure or delay by us to exercise any right shall not operate as a waiver of any other right or future right.
12. **Assignment.** You will not assign, pledge or otherwise transfer any of your rights or interests in the Lease or any Equipment without our prior written consent. Any assignment without our consent will be void. The Lease shall be binding upon any successor or permitted assignee. We may assign the Lease or our interest in the Equipment at any time without notice to you and without your consent. We may provide information about you to any prospective assignee or participant. You agree not to assert against our assignee any claims, offsets or defenses which you may have against us.
13. **Indemnity.** You are responsible for all losses, damage, claims, injuries to or the death of an individual, and attorneys' fees and costs ("Claims"), incurred or asserted by any person, in any manner related to the Equipment or the lease thereof, including its use, condition or possession. You agree to defend and indemnify us, and hold us harmless, against all Claims, although we reserve the right to control the defense and to select or approve defense counsel. You will promptly notify us of all Claims made. Your liability under this Section is not limited to the amounts of insurance required under the Lease. This indemnity continues beyond the termination of a Schedule, for acts or omissions, which occurred during the Lease Term.
14. **Representations and Warranties.** You represent and warrant to us, as of the date of this Master Agreement and of each Schedule, and covenant to us so long as the Lease is in effect, that: (a) you are a State, or a political subdivision thereof, for purposes of Section 103 of the Internal Revenue Code of 1986, as amended (the "Code"); (b) any documents required to be delivered in connection with the Lease (collectively, the "Documents") have been duly authorized by you in accordance with all applicable laws, rules, ordinances, and regulations; (c) the Documents are valid, legal, binding agreements, enforceable in accordance with their terms and the person(s) signing the Documents have the authority to do so, are acting with the full authorization of your governing body, and hold the offices indicated below their signatures; (d) the Equipment is essential to the immediate performance of a governmental or proprietary function by you within the scope of your authority and shall be used during the Lease Term only by you and only to perform such function; (e) you intend to use the Equipment for the entire Lease Term and shall take all necessary action to include in your annual budget any funds required to fulfill your obligations each fiscal period during the Lease Term; (f) you have complied fully with all applicable law governing open meetings, public bidding and appropriations, required in connection with the Lease and the debt under applicable state law; (g) your obligations to remit Lease Payments and other amounts due and to become due under the Lease constitute a current expense and not a debt under applicable state law; (h) all financial information you have provided is true and a reasonable representation of your financial condition; (i) you shall not do or cause to be done any act which shall cause, or by omission of any act allow the interest portion of any Lease Payment to become includible in our gross income for Federal income taxation purposes under the Code; (j) you shall maintain a complete and accurate account of all assignments of the Lease in the form sufficient to comply with book entry requirements of Section 149(a) of the Code and the regulations prescribed thereunder from time to time; and (k) you shall comply with the information reporting requirements of Section 149(e) of the Code. Such compliance shall include, but not be limited to, the execution of 8038-G or 8038-GC Information Returns.
15. **Governing Law; Jurisdiction; Venue.** EACH LEASE WILL BE GOVERNED BY, AND CONSTRUED IN ACCORDANCE WITH THE LAWS OF IOWA, WHERE THIS MASTER AGREEMENT IS ACCEPTED AND ENTERED INTO, except for its conflict of laws provisions. You irrevocably submit to the non-exclusive jurisdiction and venue of federal and state courts located in Des Moines, Iowa and will not claim it is an inconvenient forum for legal action. YOU AND WE IRREVOCABLY WAIVE ANY RIGHT YOU AND WE MAY HAVE TO A JURY TRIAL.
16. **Miscellaneous.** WE HAVE NOT MADE, AND DO NOT MAKE, ANY REPRESENTATION OR WARRANTY, EXPRESS OR IMPLIED, AS TO THE EQUIPMENT'S MERCHANTABILITY, FITNESS FOR A PARTICULAR PURPOSE, SUITABILITY, OR OTHERWISE. WE ARE NOT LIABLE FOR CONSEQUENTIAL OR SPECIAL DAMAGES. You acknowledge that no supplier or dealer of the Equipment is an agent of ours, or authorized to act for or bind us. You agree not to withhold any amount you owe us if you believe you have a claim against us, or any Equipment supplier(s) or manufacturer(s), but to pursue that claim independently. Any claim you have against us must be made within two years after the event that caused it. All notices must be in writing and will be deemed given 5 days after mailing to the intended recipient at its address indicated above, unless changed by a notice given in accordance with this Section. Each Lease supersedes and replaces all prior understandings and communications (oral or written) concerning the subject matter thereof. Except as otherwise provided in Section 11(d), no part of any Lease can be amended, waived or terminated except by a writing signed by both you and us. Any part of this Master Agreement may be signed in separate counterparts that, together, will constitute one document. If a court finds any part of this Master Agreement to be invalid or unenforceable, the remainder of this Master Agreement will remain in effect. You permit us to monitor and record telephone conversations between you and us.

ADDITIONAL TERMS AND CONDITIONS OF MASTER LEASE AGREEMENT

By providing any telephone number, including a mobile phone number, to us, any of our affiliates or any debt collectors we retain, we, such affiliates and such retained debt collectors can contact you using that number, including calls using an automatic dialing and announcing device and prerecorded calls, and that such calls are not "unsolicited" under state or federal law. All of our rights under each Lease shall remain in effect after the expiration of the Lease Term or termination of the Schedule.

17. **Non-Appropriation of Funds.** You intend to remit to us all Lease Payments and other payments for the full Lease Term if funds are legally available. In the event you are not granted an appropriation of funds at any time during the Lease Term for the Equipment or for equipment which is functionally similar to the Equipment and operating funds are not otherwise available to you to remit Lease Payments and other payments due and to become due under the Lease, and there is no other legal procedure or available funds by or with which payment can be made to us, and the non-appropriation did not result from an act or omission by you, you shall have the right to return the Equipment in accordance with Section 9 of this Master Agreement and terminate the Lease on the last day of the fiscal period for which appropriations were received without penalty or expense to you, except as to the portion of the Lease Payments for which funds shall have been appropriated and budgeted. At least thirty (30) days prior to the end of your fiscal period, your chief executive officer (or legal counsel) shall certify in writing that (a) funds have not been appropriated for the fiscal period, (b) such non-appropriation did not result from any act or failure to act by you, and (c) you have exhausted all funds legally available to pay Lease Payments. If you terminate the Lease because of a non-appropriation of funds, you may not, to the extent permitted by applicable law, purchase, lease, or rent, during the subsequent fiscal period, equipment performing the same functions as, or functions taking the place of, those performed by the Equipment. This Section 17 shall not permit you to terminate the Lease in order to acquire any other equipment or to allocate funds directly or indirectly to perform essentially the application for which the Equipment is intended.

If you terminate the Lease because of a non-appropriation of funds, the provisions of Section 8 shall not apply.

<p>THE TERMS OF THIS MASTER AGREEMENT SHOULD BE READ CAREFULLY BEFORE SIGNING BECAUSE ONLY THESE WRITTEN TERMS ARE ENFORCEABLE NO OTHER TERMS OR ORAL PROMISES MAY BE LEGALLY ENFORCED. BY SIGNING THIS MASTER AGREEMENT, YOU AGREE TO ALL OF THE TERMS AND CONDITIONS SET FORT IN THIS MASTER AGREEMENT. THIS MASTER AGREEMENT IS THE COMPLETE AND EXCLUSIVE STATEMENT OF THE AGREEMENT BETWEEN YOU AND US, EXCEPT AS WE MAY LATER AGREE IN WRITING TO MODIFY IT.</p>	
<p>LESSEE CITY OF FLINT 1101 S SAGINAW ST FLINT, MI 48502-1420</p>	<p>LESSOR DEERE CREDIT, INC. 6400 NW 86th ST, PO BOX 6600 JOHNSTON, IA 50131-6600</p>
<p>By:  KAREN W WEAVER, MAYOR</p>	<p>By: _____</p>
<p>Date: <u>11/9/2017</u></p>	<p>Date: _____</p>

Approval as to Form:

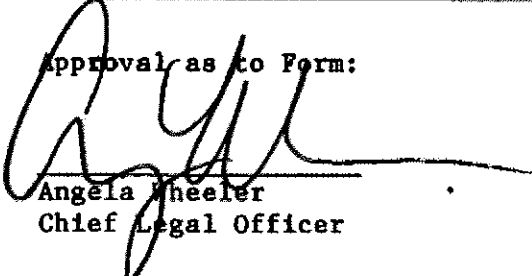
 Angela Wheeler
 Chief Legal Officer



AMENDMENT TO MASTER LEASE AGREEMENT

This Amendment to Master Lease Agreement (this "Amendment") amends and supplements that certain Master Lease Agreement No. 0063090 dated as of the ____ day of _____, 20__ (the "Lease") by and between **Deere Credit, Inc.** ("Lessor", "we", "us" or "our") and **City of Flint** ("Lessee", "you" or "your").

RECITALS

WHEREAS, Lessee and Lessor desire to amend the terms and conditions of the Lease to further clarify certain provisions set forth therein;

NOW, THEREFORE, in consideration of the mutual covenants contained in this Amendment and for other good and valuable consideration, the receipt and sufficiency of which is expressly acknowledged, the parties agree as follows:

1. Capitalized terms not defined in this Amendment shall have the meaning given to them in the Lease.
2. Section 6 of the Lease is hereby deleted in its entirety and replaced with the following:

"6. Insurance.

6.1 Lessee, at its own expense, will either (a) carry public liability insurance having an endorsement for contractual liability on the Equipment with minimum liability limits in the amounts of \$1,000,000 per occurrence for bodily injury, including death, and in the minimum amount of \$250,000 per occurrence for property damage, or (b) self-insure against any and all losses, claims, liabilities, demands and expenses whatsoever in connection with (i) any death or personal injury caused by the Equipment, and/or (ii) any property damage caused by the Equipment. Nothing contained herein shall be construed to require Lessee to indemnify or defend Lessor against any third-party claims against Lessor.

6.2 Lessee, at its own expense, shall either (a) self-insure against all risks of physical loss or damage to the Equipment for its actual cash value, or (b) keep the Equipment insured against all risk of physical loss or damage for no less than its actual cash value. Such insurance shall include a loss payable clause made out in favor of Lessor.

6.3 Lessee shall deliver to Lessor certificates or other evidence satisfactory to Lessor that insurance is maintained as required under Sections 6.1 and 6.2. If Lessee fails to deliver such certificates or other evidence of insurance to Lessor upon request, Lessor shall assume that Lessee has elected to self-insure against such risks and indemnify Lessor pursuant to the provisions of Section 6.1 and 6.2.

6.4 All of the foregoing obligations shall survive the expiration or termination of this Lease and shall be payable by Lessee within thirty (30) days of receipt of Lessor's invoice."

3. Section 13 of the Lease is hereby deleted in its entirety and replaced with the following:

"13. Claims. To the extent permitted by law, you are responsible for all losses, damage, claims, injuries to or the death of an individual, and attorneys' fees and costs ("Claims"),

incurred or asserted by any person, in any manner related to your lease, use or possession of the Equipment. You will promptly notify us of all Claims you become aware of. You agree to not bring any action for Claims against us as lessor of the Equipment. Nothing herein is intended to or shall be construed as a waiver of any rights or claims you may have against the manufacturer or distributor of the Equipment. This provision shall continue beyond the termination of a Schedule for acts or omissions which occurred during the Lease Term."

4. Except as expressly amended by this Amendment, the terms and conditions of the Lease shall remain in full force and effect. This Amendment constitutes the complete understanding of the parties hereto and supersedes all prior understandings of the parties relating to the matters discussed herein. This Amendment may only be amended or modified by the terms of a written instrument signed by all parties hereto. This Amendment may be executed in any number of counterparts, each of which shall be an original and all of which, when taken together shall constitute one and the same document. This Amendment shall be governed by and construed in accordance with the laws of the State of Iowa.

IN WITNESS WHEREOF, the parties have caused this Amendment to be executed by their duly authorized representatives as of this ____ day of _____, 20__.

DEERE CREDIT, INC.

CITY OF FLINT

By: _____

By: Karen W. Weaver

Name: _____

Name: Karen W. Weaver

Title: _____

Title: Mayor

Approval as to Form:

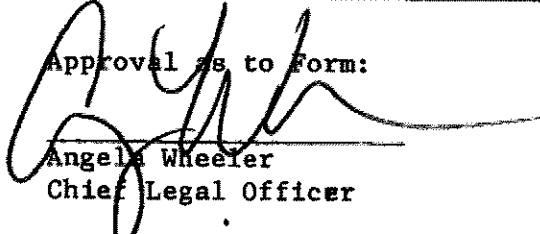

Angela Wheeler
Chief Legal Officer



RESOLUTION NO.: 240283

PRESENTED: 7-17-2024

ADOPTED: _____

Resolution Authorizing the Maintenance Renewal of Police Management System Tyler Technologies New World Systems for FY25

BY THE CITY ADMINISTRATOR:

WHEREAS, The City of Flint Police Department is requesting the maintenance renewal of Tyler Technologies New World Systems Software; and

WHEREAS, The City of Flint Police Department utilizes Tyler Technologies New World Systems software for CAD, Law Enforcement Records, Fire Records, Public Safety Interface, Photo Imaging, Mobile Management server, and Mobile Client Laptop.

Account Number	Account Name	Amount
101-301.000-931.000	Maintenance	\$82,710.55

IT IS RESOLVED, That the proper City Officials, upon the City Council approval, are hereby authorized to enter into an agreement for standard software maintenance with Tyler Technologies New World System for the period July 1, 2024 through June 30, 2025, not to exceed \$82,710.55.

APPROVED AS TO FORM:

Will Kim
William Kim (Jun 25, 2024 09:03 EDT)

Will Kim, Chief Legal Officer

APPROVED AS TO FINANCE:

Phillip Moore
Phillip Moore (Jun 25, 2024 12:35 EDT)

Phillip Moore, Chief Financial Officer

FOR THE CITY OF FLINT:

Clyde D. Edwards
CLYDE D EDWARDS / A0235 (Jun 25, 2024 12:51 EDT)

Clyde Edwards, City Administrator

APPROVED BY CITY COUNCIL:

City Council President

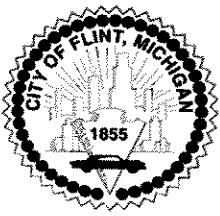

CITY OF FLINT STAFF REVIEW FORM

TODAY'S DATE: 6/20/24

BID/PROPOSAL#

AGENDA ITEM TITLE: Resolution Authorizing the Maintenance Renewal of Police Management System Tyler Technologies New World Systems for FY25

PREPARED BY: Angela Amerman

VENDOR NAME: Tyler Technologies

BACKGROUND/SUMMARY OF PROPOSED ACTION:

The Police Department is requesting the approval of the Tyler Technologies requisition in the amount of \$82,710.55. This requisition is the maintenance agreement renewal of the Police records management system.

PREVIOUS ALLOCATIONS (INCLUDE ALL ACCOUNTS USED FOR THIS PURPOSE)/ PROVIDE RESOLUTION OR CONTRACT INFORMATION THAT APPLIES

The Police Department has been using this records management system since 07/01/2015.

POSSIBLE BENEFIT TO THE CITY OF FLINT (RESIDENTS AND/OR CITY OPERATIONS) INCLUDE PARTNERSHIPS AND COLLABORATIONS:

This benefits the Police Department with its operations.

FINANCIAL IMPLICATIONS:

This is an FY25 budgeted expense.

BUDGETED EXPENDITURE? YES NO IF NO, PLEASE EXPLAIN:

Dept.	Name of Account	Account Number	Grant Code	Amount
Police	Maintenance Agreements	101-301.000-931.000		\$82,710.55
FY25 GRAND TOTAL				\$82,710.55



CITY OF FLINT STAFF REVIEW FORM

PRE-ENCUMBERED? YES NO REQUISITION NO:

ACCOUNTING APPROVAL: Angela Amerman
Angela Amerman (Jun 24, 2024 12:28 EDT) Date: _____

WILL YOUR DEPARTMENT NEED A CONTRACT? YES NO

WHEN APPLICABLE, IF MORE THAN ONE (1) YEAR, PLEASE ESTIMATE TOTAL AMOUNT FOR EACH BUDGET YEAR: *(This will depend on the term of the bid proposal)*

BUDGET YEAR 1 \$82,710.55

OTHER IMPLICATIONS *(i.e., collective bargaining)*:

STAFF RECOMMENDATION: *(PLEASE SELECT)*: APPROVED NOT APPROVED

DEPARTMENT HEAD SIGNATURE: Terence Green
Terence Green (Jun 25, 2024 06:09 EDT)
(Terence Green, Police Chief)

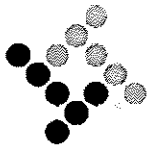

tyler
technologies

Remittance:
Tyler Technologies, Inc
(FEIN 75-2303920)
P.O. Box 203556
Dallas, TX 75320-3556

Invoice

Invoice No	Date	Page
130-146747	06/01/2024	1 of 3

Questions:
Tyler Technologies- Public Safety
Phone: 1-800-772-2260 Press 2, then 5
Email: ar@tylertech.com

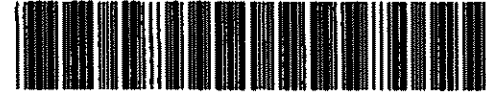

Bill To FLINT, MI POLICE DEPARTMENT
PO BOX 246
FLINT, MI 48501-0246

Ship To FLINT, MI POLICE DEPARTMENT
PO BOX 246
FLINT, MI 48501-0246

Cust No.-BillTo-ShipTo	Ord No	PO Number	Currency	Terms	Due Date
49941 - MAIN - MAIN	31577		USD	NET30	07/01/2024

Contract Date	Description	Units	Rate	Extended Price
Contract No.: Flint, MI Police Departm				
01/Jul/2020	New World Fire Mobile Unit Standard Maintenance - Mobile Upload of Field Reports Cycle: Start: 01/Jul/2024, End: 30/Jun/2025	80	44.41	3,552.80
01/Jul/2020	Briefing Notes - Maintenance Cycle: Start: 01/Jul/2024, End: 30/Jun/2025	1	1,604.03	1,604.03
01/Jul/2020	Bookings - Maintenance Cycle: Start: 01/Jul/2024, End: 30/Jun/2025	1	2,220.87	2,220.87
01/Jul/2020	Case Management - Maintenance Cycle: Start: 01/Jul/2024, End: 30/Jun/2025	1	1,480.15	1,480.15
01/Jul/2020	Data Analysis/Crime Mapping/Management Reporting (LERMS) - Maintenance Cycle: Start: 01/Jul/2024, End: 30/Jun/2025	1	4,441.74	4,441.74
01/Jul/2020	Field Investigations - Maintenance Cycle: Start: 01/Jul/2024, End: 30/Jun/2025	1	1,480.15	1,480.15
01/Jul/2020	Gang Tracking - Maintenance Cycle: Start: 01/Jul/2024, End: 30/Jun/2025	1	2,467.34	2,467.34
01/Jul/2020	Gun Permits and Registrations - Maintenance Cycle: Start: 01/Jul/2024, End: 30/Jun/2025	1	1,480.15	1,480.15
01/Jul/2020	New World Standard Maintenance - Identix Interface MSP Cycle: Start: 01/Jul/2024, End: 30/Jun/2025	1	1,480.15	1,480.15
01/Jul/2020	Federal UCR/IBR - Maintenance Cycle: Start: 01/Jul/2024, End: 30/Jun/2025	1	1,480.15	1,480.15
01/Jul/2020	New World MSP Single Jurisdiction Law Enforcement CAD - Maintenance Cycle: Start: 01/Jul/2024, End: 30/Jun/2025	80	129.54	10,363.20
01/Jul/2020	Narcotics Management - Maintenance Cycle: Start: 01/Jul/2024, End: 30/Jun/2025	1	1,850.51	1,850.51
01/Jul/2020	Property Room Bar Coding - LERMS - Maintenance Cycle: Start: 01/Jul/2024, End: 30/Jun/2025	1	1,480.15	1,480.15
01/Jul/2020	Equipment Tracking and Maintenance - Maintenance Cycle: Start: 01/Jul/2024, End: 30/Jun/2025	1	0.00	0.00
01/Jul/2020	NFIRS 5.0 Electronic Reporting - Maintenance Cycle: Start: 01/Jul/2024, End: 30/Jun/2025	1	1,604.03	1,604.03
01/Jul/2020	Citizen Reporting Interface - Maintenance Cycle: Start: 01/Jul/2024, End: 30/Jun/2025	1	2,837.70	2,837.70
01/Jul/2020	On-Line Impounds Interface to State/NCIC - Maintenance Cycle: Start: 01/Jul/2024, End: 30/Jun/2025	1	1,357.55	1,357.55
01/Jul/2020	New World Fire Records Standard Maintenance Base Package	18	452.37	8,142.66

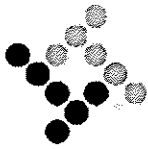

tyler
technologies

Remittance:
Tyler Technologies, Inc
(FEIN 75-2303920)
P.O. Box 203556
Dallas, TX 75320-3556

Invoice

Invoice No	Date	Page
130-146747	06/01/2024	2 of 3

Questions:
Tyler Technologies- Public Safety
Phone: 1-800-772-2260 Press 2, then 5
Email: ar@tylertech.com

Bill To: FLINT, MI POLICE DEPARTMENT
PO BOX 246
FLINT, MI 48501-0246

Ship To: FLINT, MI POLICE DEPARTMENT
PO BOX 246
FLINT, MI 48501-0246

Cust No.-BillTo-ShipTo	Ord No	PO Number	Currency	Terms	Due Date
49941 - MAIN - MAIN	31577		USD	NET30	07/01/2024

Contract Date	Description	Units	Rate	Extended Price
	Cycle: Start: 01/Jul/2024, End: 30/Jun/2025			
01/Jul/2020	New World Third Party Maintenance - ArcGIS Advanced Enterprise Server Integration Cycle: Start: 01/Jul/2024, End: 30/Jun/2025	1	2,662.01	2,662.01
01/Jul/2020	Law Enforcement Management Data Mart (*CAD, RMS) Standard Maintenance - Includes 2 users Cycle: Start: 01/Jul/2024, End: 30/Jun/2025	2	370.36	740.72
01/Jul/2020	Web Query - Maintenance Cycle: Start: 01/Jul/2024, End: 30/Jun/2025	1	2,467.34	2,467.34
01/Jul/2020	New World Field Reporting Server Standard Maintenance Cycle: Start: 01/Jul/2024, End: 30/Jun/2025	30	28.78	863.40
01/Jul/2020	New World Decision Support Base Datamart Standard Maintenance Cycle: Start: 01/Jul/2024, End: 30/Jun/2025	1	0.00	0.00
01/Jul/2020	New World Mobile on MSP Server Integration Standard Maintenance - Mobile Upload Software (16-30 units) Cycle: Start: 01/Jul/2024, End: 30/Jun/2025	30	65.83	1,974.90
01/Jul/2020	Mugshot Image Download - Maintenance Cycle: Start: 01/Jul/2024, End: 30/Jun/2025	20	104.86	2,097.20
01/Jul/2020	Field Investigation Field Reporting (1 form) - Maintenance Cycle: Start: 01/Jul/2024, End: 30/Jun/2025	80	27.76	2,220.80
01/Jul/2020	Public Safety Lineups/Mug Shots (LERMS) - Maintenance Cycle: Start: 01/Jul/2024, End: 30/Jun/2025	1	4,934.71	4,934.71
01/Jul/2020	New World State/NCIC Interface - Maintenance Cycle: Start: 01/Jul/2024, End: 30/Jun/2025	1	2,713.84	2,713.84
01/Jul/2020	New World Data Merge to Aegis/MSP LE Records Standard Maintenance Cycle: Start: 01/Jul/2024, End: 30/Jun/2025	30	7.41	222.30
01/Jul/2020	New World Law Enforcement Mobile Unit Standard Maintenance - Field-Based Reporting - LE Field Reporting Compliance Cycle: Start: 01/Jul/2024, End: 30/Jun/2025	80	14.81	1,184.80
01/Jul/2020	New World Law Enforcement Mobile Unit Standard Maintenance - Mobile Message - LE State/NCIC via Switch Cycle: Start: 01/Jul/2024, End: 30/Jun/2025	50	80.48	4,024.00
01/Jul/2020	LE Field Reporting (Federal Standard) - Maintenance Cycle: Start: 01/Jul/2024, End: 30/Jun/2025	80	74.04	5,923.20
01/Jul/2020	New World Mobile on MSP Server Integration Standard Maintenance - MDT/MCT Base CAD/RMS Interface (51-100 units) Cycle: Start: 01/Jul/2024, End: 30/Jun/2025	100	13.58	1,358.00

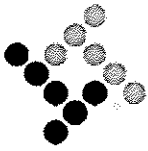

tyler
technologies

Remittance:
Tyler Technologies, Inc
(FEIN 75-2303920)
P.O. Box 203556
Dallas, TX 75320-3556

Invoice

Invoice No	Date	Page
130-146747	06/01/2024	3 of 3

Questions:
Tyler Technologies- Public Safety
Phone: 1-800-772-2260 Press 2, then 5
Email: ar@tylertech.com

Bill To: FLINT, MI POLICE DEPARTMENT
PO BOX 246
FLINT, MI 48501-0246

Ship To: FLINT, MI POLICE DEPARTMENT
PO BOX 246
FLINT, MI 48501-0246

Cust No.-BillTo-ShipTo	Ord No	PO Number	Currency	Terms	Due Date
49941 - MAIN - MAIN	31577		USD	NET30	07/01/2024

Contract Date	Description	Units	Rate	Extended Price
---------------	-------------	-------	------	----------------

****ATTENTION****

Order your checks and forms from
Tyler Business Forms at 877-749-2090 or
tylerbusinessforms.com to guarantee
100% compliance with your software.

Subtotal 82,710.55

Sales Tax \$0.00

Invoice Total 82,710.55



RESOLUTION NO.: 230216
 PRESENTED: JUL 19 2023
 ADOPTED: JUL 31 2023

Resolution Authorizing the Maintenance Renewal of Police Management System Tyler Technologies New World Systems for FY24

BY THE CITY ADMINISTRATOR:

WHEREAS, the City of Flint Police Department is requesting the maintenance renewal of Tyler Technologies New World Systems Software; and

WHEREAS, the City of Flint Police Department utilize Tyler Technologies New World Systems software for CAD, Law Enforcement Records, Fire Records, Public Safety Interface, Photo Imaging, Mobile Management server, and Mobile Client Laptop; and

Account Number	Account Name	Amount
101-303.200-931.000	Maintenance Agreements	\$78,028.72

IT IS RESOLVED, that the proper City Officials, upon the City Council approval, are hereby authorized to enter into an agreement for standard software maintenance with Tyler Technologies New World System for the period July 1, 2023 through June 30, 2024, not to exceed \$78,028.72.

APPROVED AS TO FORM:

Will Kim (Jul 7, 2023 15:50 EDT)

Will Kim, Chief Legal Officer

APPROVED AS TO FINANCE:

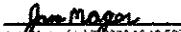
Jane Mager (Jul 19, 2023 16:10 EDT)

Jane Mager, Acting Chief Financial Officer

FOR THE CITY OF FLINT:

CLYDE D EDWARDS (Jul 13, 2023 11:43 EDT)

Clyde Edwards, City Administrator

APPROVED BY CITY COUNCIL:



City Council President



CITY OF FLINT

RESOLUTION STAFF REVIEW FORM

TODAY'S DATE: 6/20/23

BID/PROPOSAL#

AGENDA ITEM TITLE: Resolution Authorizing the Maintenance Renewal of Police Management System Tyler Technologies New World Systems for FY24

PREPARED BY Angela Amerman Finance/Police

(Please type name and Department)

VENDOR NAME: Tyler Technologies

BACKGROUND/SUMMARY OF PROPOSED ACTION: The Police Department is requesting the approval of the Tyler Technologies in the amount of \$78,028.72. This is the maintenance agreement renewal of the Police records management system.

FINANCIAL IMPLICATIONS:

BUDGETED EXPENDITURE? YES [X] NO [] IF NO, PLEASE EXPLAIN:

Table with 5 columns: Dept., Name of Account, Account Number, Grant Code, Amount. Row 1: Police, Maintenance Agreements, 10-303.200-931.000, \$78,082.72. Row 2: FY23/24 GRAND TOTAL, \$78,082.72

PRE-ENCUMBERED? YES [] NO [] REQUISITION NO:

ACCOUNTING APPROVAL: Angela Amerman Date: 6/20/23



CITY OF FLINT

WILL YOUR DEPARTMENT NEED A CONTRACT? YES NO
(If yes, please indicate how many years for the contract) YEARS

WHEN APPLICABLE, IF MORE THAN ONE (1) YEAR, PLEASE ESTIMATE TOTAL AMOUNT FOR EACH BUDGET YEAR: *(This will depend on the term of the bid proposal)*

BUDGET YEAR 1

BUDGET YEAR 2

BUDGET YEAR 3

OTHER IMPLICATIONS *(i.e., collective bargaining)*:

STAFF RECOMMENDATION: *(PLEASE SELECT)*: **APPROVED** **NOT APPROVED**

DEPARTMENT HEAD SIGNATURE: _____
(PLEASE TYPE NAME, TITLE)



Remittance:
 Tyler Technologies, Inc
 (FEIN 75-2303920)
 P.O. Box 203556
 Dallas, TX 75320-3556

Invoice

Invoice No	Date	Page
130-136766	06/01/2023	1 of 3

Questions:
 Tyler Technologies- Public Safety
 Phone: 1-800-772-2260 Press 2, then 5
 Email: ar@tylertech.com



Bill To: FLINT, MI POLICE DEPARTMENT
 PO BOX 246
 FLINT, MI 48501-0246

Ship To: FLINT, MI POLICE DEPARTMENT
 PO BOX 246
 FLINT, MI 48501-0246

Cust No.-BillTo-ShipTo	Ord No	PO Number	Currency	Terms	Due Date
49941 - MAIN - MAIN	25233		USD	NET30	07/01/2023

Date	Description	Units	Rate	Extended Price
Contract No.: Flint, MI Police Departm				
	New World Fire Mobile Unit Standard Maintenance - Mobile Upload of Field Reports	80	41.90	3,352.00
	Maintenance: Start: 01/Jul/2023, End: 30/Jun/2024			
	Briefing Notes - Maintenance	1	1,513.24	1,513.24
	Maintenance: Start: 01/Jul/2023, End: 30/Jun/2024			
	Bookings - Maintenance	1	2,095.16	2,095.16
	Maintenance: Start: 01/Jul/2023, End: 30/Jun/2024			
	Case Management - Maintenance	1	1,396.37	1,396.37
	Maintenance: Start: 01/Jul/2023, End: 30/Jun/2024			
	Data Analysis/Crime Mapping/Management Reporting (LERMS) - Maintenance	1	4,190.32	4,190.32
	Maintenance: Start: 01/Jul/2023, End: 30/Jun/2024			
	Field Investigations - Maintenance	1	1,396.37	1,396.37
	Maintenance: Start: 01/Jul/2023, End: 30/Jun/2024			
	Gang Tracking - Maintenance	1	2,327.68	2,327.68
	Maintenance: Start: 01/Jul/2023, End: 30/Jun/2024			
	Gun Permits and Registrations - Maintenance	1	1,396.37	1,396.37
	Maintenance: Start: 01/Jul/2023, End: 30/Jun/2024			
	New World Standard Maintenance - Identix Interface MSP	1	1,396.37	1,396.37
	Maintenance: Start: 01/Jul/2023, End: 30/Jun/2024			
	Federal UCR/IBR - Maintenance	1	1,396.37	1,396.37
	Maintenance: Start: 01/Jul/2023, End: 30/Jun/2024			
	New World MSP Single Jurisdiction Law Enforcement CAD - Maintenance	80	122.21	9,776.80
	Maintenance: Start: 01/Jul/2023, End: 30/Jun/2024			
	Narcotics Management - Maintenance	1	1,745.76	1,745.76
	Maintenance: Start: 01/Jul/2023, End: 30/Jun/2024			
	Property Room Bar Coding - LERMS - Maintenance	1	1,396.37	1,396.37
	Maintenance: Start: 01/Jul/2023, End: 30/Jun/2024			
	Equipment Tracking and Maintenance - Maintenance	1	0.00	0.00
	Maintenance: Start: 01/Jul/2023, End: 30/Jun/2024			
	NFIRS 5.0 Electronic Reporting - Maintenance	1	1,513.24	1,513.24
	Maintenance: Start: 01/Jul/2023, End: 30/Jun/2024			
	Citizen Reporting Interface - Maintenance	1	2,677.08	2,677.08
	Maintenance: Start: 01/Jul/2023, End: 30/Jun/2024			
	On-Line Impounds Interface to State/NCIC - Maintenance	1	1,280.71	1,280.71
	Maintenance: Start: 01/Jul/2023, End: 30/Jun/2024			
	New World Fire Records Standard Maintenance Base Package	18	426.76	7,681.68
	Maintenance: Start: 01/Jul/2023, End: 30/Jun/2024			



Remittance:
 Tyler Technologies, Inc
 (FEIN 75-2303920)
 P.O. Box 203556
 Dallas, TX 75320-3556

Invoice

Invoice No	Date	Page
130-136766	06/01/2023	2 of 3

Questions:
 Tyler Technologies- Public Safety
 Phone: 1-800-772-2260 Press 2, then 5
 Email: ar@tylertech.com

Bill To: FLINT, MI POLICE DEPARTMENT
 PO BOX 246
 FLINT, MI 48501-0246

Ship To: FLINT, MI POLICE DEPARTMENT
 PO BOX 246
 FLINT, MI 48501-0246

Cust No.-BillTo-ShipTo	Ord No	PO Number	Currency	Terms	Due Date
49941 - MAIN - MAIN	25233		USD	NET30	07/01/2023

Date	Description	Units	Rate	Extended Price
	New World Third Party Maintenance - ArcGIS Advanced Enterprise Server Integration Maintenance: Start: 01/Jul/2023, End: 30/Jun/2024	1	2,511.33	2,511.33
	Law Enforcement Management Data Mart (^CAD, RMS) Standard Maintenance - Includes 2 users Maintenance: Start: 01/Jul/2023, End: 30/Jun/2024	2	349.40	698.80
	Web Query - Maintenance Maintenance: Start: 01/Jul/2023, End: 30/Jun/2024	1	2,327.68	2,327.68
	New World Field Reporting Server Standard Maintenance Maintenance: Start: 01/Jul/2023, End: 30/Jun/2024	30	27.15	814.50
	New World Decision Support Base Datamart Standard Maintenance Maintenance: Start: 01/Jul/2023, End: 30/Jun/2024	1	0.00	0.00
	New World Mobile on MSP Server Integration Standard Maintenance - Mobile Upload Software (16-30 units) Maintenance: Start: 01/Jul/2023, End: 30/Jun/2024	30	62.10	1,863.00
	Mugshot Image Download - Maintenance Maintenance: Start: 01/Jul/2023, End: 30/Jun/2024	20	98.92	1,978.40
	Field Investigation Field Reporting (1 form) - Maintenance Maintenance: Start: 01/Jul/2023, End: 30/Jun/2024	80	26.19	2,095.20
	Public Safety Lineups/Mug Shots (LERMS) - Maintenance Maintenance: Start: 01/Jul/2023, End: 30/Jun/2024	1	4,655.39	4,655.39
	New World State/NCIC Interface - Maintenance Maintenance: Start: 01/Jul/2023, End: 30/Jun/2024	1	2,560.23	2,560.23
	New World Data Merge to Aegis/MSP LE Records Standard Maintenance Maintenance: Start: 01/Jul/2023, End: 30/Jun/2024	30	6.99	209.70
	New World Law Enforcement Mobile Unit Standard Maintenance - Field-Based Reporting - LE Field Reporting Compliance Maintenance: Start: 01/Jul/2023, End: 30/Jun/2024	80	13.97	1,117.60
	New World Law Enforcement Mobile Unit Standard Maintenance - Mobile Message - LE State/NCIC via Switch Maintenance: Start: 01/Jul/2023, End: 30/Jun/2024	50	75.92	3,796.00
	LE Field Reporting (Federal Standard) - Maintenance Maintenance: Start: 01/Jul/2023, End: 30/Jun/2024	80	69.85	5,588.00
	New World Mobile on MSP Server Integration Standard Maintenance - MDT/MCT Base CAD/RMS Interface (51-100 units) Maintenance: Start: 01/Jul/2023, End: 30/Jun/2024	100	12.81	1,281.00

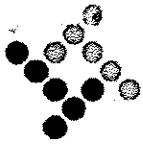

tyler
technologies

Remittance:
Tyler Technologies, Inc
(FEIN 75-2303920)
P.O. Box 203556
Dallas, TX 75320-3556

Invoice

Invoice No	Date	Page
130-136766	06/01/2023	3 of 3

Questions:
Tyler Technologies- Public Safety
Phone: 1-800-772-2260 Press 2, then 5
Email: ar@tylertech.com

Bill To: FLINT, MI POLICE DEPARTMENT
PO BOX 246
FLINT, MI 48501-0246

Ship To: FLINT, MI POLICE DEPARTMENT
PO BOX 246
FLINT, MI 48501-0246

Cust No.-BillTo-ShipTo	Ord No	PO Number	Currency	Terms	Due Date
49941 - MAIN - MAIN	25233		USD	NET30	07/01/2023

Date	Description	Units	Rate	Extended Price
------	-------------	-------	------	----------------

****ATTENTION****

Order your checks and forms from
Tyler Business Forms at 877-749-2090 or
tylerbusinessforms.com to guarantee
100% compliance with your software.

Subtotal	78,028.72
Sales Tax	0.00
Invoice Total	78,028.72



240284

RESOLUTION NO.: _____

PRESENTED: 7-17-2024

ADOPTED: _____

BY THE CITY ADMINISTRATOR:

RESOLUTION APPROVING REALLOCATION OF ARPA FUNDS AND OPIOID FUNDS TO AWARD GRANTS FOR EMERGENCY WATER RELIEF FUNDS

In 2022 and 2023, the City of Flint received funds pursuant to the American Rescue Plan Act of 2021 (ARPA), which could be used by the City for specific and defined purposes. In 2022, the City of Flint obligated all of the ARPA funding received, of which approximately \$40 million was obligated as “revenue replacement” of December 20, 2023; and

In 2023 and 2024, the City of Flint received funds from the National Opioid Settlement of which 30% can be used for any lawful public purpose; and,

The City Administration recommends reallocating \$50,000 of ARPA funds previously obligated to revenue replacement, and \$50,000 of unallocated Opioid Funds to provide emergency water payment assistance. The total transfer of \$100,000 is recommended to go to Emergency Water/Sewer Relief to provide water bill relief to tenants.

Fund/Account Name	Account Number	Use	Source of Funds
General Fund – ARPA Revenue Replacement	101-000.000-385.287		\$50,000.00
Opioid Fund (Unallocated)	288-266.210-963.000		\$50,000.00
General Fund - Water Emergency Relief	TBA	\$100,000.00	
	Total	\$100,000.00	\$100,000.00

IT IS RESOLVED, that the appropriate City officials are authorized to transfer \$50,000 from ARPA Revenue Replacement (General Fund 101 account 101-000.000-385.287) and \$50,000 from the Opioid Fund Balance (Opioid Fund 288 account #288-266.210-963.000) to Water/Sewer Emergency Relief for emergency water/sewer payment assistance.

APPROVED AS TO FORM:

APPROVED AS TO FINANCE:

William Kim (Jul 10, 2024 15:29 EDT)

William Kim, City Attorney
CLYDE D EDWARDS / A0252
CLYDE D EDWARDS / A0252 (Jul 10, 2024 15:36 EDT)

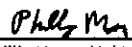
Phillip Moore (Jul 10, 2024 15:02 EDT)

Phillip Moore, Chief Financial Officer

Clyde Edwards, City Administrator

City Council

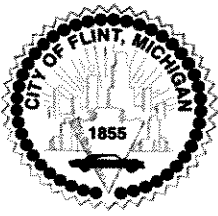

CITY OF FLINT STAFF REVIEW FORM

Revised July 2, 2024

TODAY'S DATE: July 9, 2024

AGENDA ITEM TITLE: Additional Emergency Water/Sewer Relief Fund

PREPARED BY: Phillip Moore

Section I: BACKGROUND/SUMMARY OF PROPOSED ACTION:

The City Administration recommends reallocating \$50,000 of Opioid Funds and \$50,000 of ARPA funds, previously obligated for revenue replacement, to provide funding to the City of Flint for emergency water/sewer relief funds for the residents. A water bill relief credit for emergency water relief only will provide immediate financial relief to residents, many of whom are disproportionately minorities and are low to moderate-income earners. This program will be targeted at tenants since resolution 240182 targeted homeowners.

Section II. PREVIOUS ALLOCATIONS (INCLUDE ALL ACCOUNTS USED FOR THIS PURPOSE)/ PROVIDE RESOLUTION OR CONTRACT INFORMATION THAT APPLIES

The administration allotted up to \$8,600,000 towards water bill relief in the amount of a \$300 credit per residential account, the equivalent of three months of the average water bill. Funding for this project shall come from the American Rescue Plan Act fund (287). The water relief credit was applied on June 30, 2022. The remaining balance is \$174,594.63, with revenue replacement at \$30,000 and a \$25,000 contingency fund, and from the administration budget, 20,405.37 will be used for this resolution. This is a companion resolution to resolution #240182 for \$250,000 sent to the council and has yet to be approved.

Section III. POSSIBLE BENEFIT TO THE CITY OF FLINT (RESIDENTS AND/OR CITY OPERATIONS) INCLUDE PARTNERSHIPS AND COLLABORATIONS:

The designated purpose of ARPA funding is to replace lost revenue. The City of Flint is owed \$10 million in unpaid water bills, much of this dating to the pandemic when the administration placed moratoriums on water shutoffs to stop the spread of COVID-19. Flint residents continue to face hardship in paying their water bills, and no assistance programs are currently available. To recover lost revenue to stabilize the water system's finances and support residents unable to pay their bills, the City of Flint proposes to use \$50,000 in ARPA funds and \$50,000 in Opioid Funds for emergency water/sewer bill assistance for tenant residents.

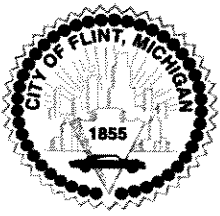

CITY OF FLINT STAFF REVIEW FORM

Revised July 2, 2024

Section IV: FINANCIAL IMPLICATIONS:

In 2022 and 2023, the City of Flint received funds pursuant to the American Rescue Plan Act of 2021 (ARPA), which could be used by the City for specific and defined purposes. In 2023, the City of Flint obligated all the ARPA funding received, of which approximately \$40 million was obligated as “revenue replacement;” City Administration recommends reallocating \$50,000 of ARPA funds, previously obligated for revenue replacement, to provide funding to the City of Flint Water/Sewer Emergency Relief Funds. In addition, \$50,000 of Opioid Funds will be provided to the City of Flint Water/Sewer Emergency Relief Funds.

After a thorough analysis from the E&Y consulting team, the proposed program complies with relevant CDE/ authorized administration version Treasury rules and aligns with the Flint ARPA Plan.

BUDGETED EXPENDITURE? YES NO IF NO, PLEASE EXPLAIN:

Dept.	Name of Account	Account Number	Grant Code	Amount
Mayor's Office	Water Emergency Relief Funds	101-000.000-385.287	Contingency	\$50,000
	Opioid Fund	288-266.210-963.000		\$50,000
FY25 GRAND TOTAL				\$100,000

PRE-ENCUMBERED? YES NO REQUISITION NO:

ACCOUNTING APPROVAL: 

Chay Linseman, Budget & Grants Admin.

WILL YOUR DEPARTMENT NEED A CONTRACT? YES NO

WHEN APPLICABLE, IF MORE THAN ONE (1) YEAR, PLEASE ESTIMATE TOTAL AMOUNT FOR EACH BUDGET YEAR: (This will depend on the term of the bid proposal) N/A

OTHER IMPLICATIONS (i.e., collective bargaining):

STAFF RECOMMENDATION: (PLEASE SELECT): APPROVED NOT APPROVED

DEPARTMENT HEAD SIGNATURE: 

Phillip Moore (Jul 10, 2024 15:02 EDT)

Phillip Moore, Chief Financial Officer

240285



RESOLUTION NO.: _____

PRESENTED: 7-17-2024

ADOPTED: _____

BY THE CITY ADMINISTRATOR:

RESOLUTION AWARDING A CONTRACT TO GENESEE CONSERVATION DISTRICT FOR INSPECTING TREES IMPACTING SIDEWALKS THROUGHOUT THE CITY OF FLINT

On October 24, 2022, the Flint City Council allocated funding of American Rescue Plan Act (ARPA) funds for tree replacements, via Resolution 220464.1.

To implement that resolution, the City of Flint, Division of Purchases & Supplies, solicited proposals for tree services in the right-of-way as requested by the Department of Public Works, Transportation Division. The City of Flint Urban Forestry Management Plan requires City owned trees to be inspected by a professional.

Staff recommend awarding a contract to Genesee Conservation District (Genesee Soil & Water Conservation), 1525 N. Elms Rd., Flint, MI 48532 as they inspect City of Flint trees through a Memorandum of Understanding.

Reallocated funds will be moved from fund: 101-287.000-963.000 as follows:

Account Number	Account Name	Amount
101-449.217.801.000	Tree Maintenance – ARPA (RR)	\$ 200,000.00
	FY24/FY25/FY26 GRAND TOTAL	\$ 200,000.00

IT IS RESOLVED, that the appropriate City Officials are authorized to do all things necessary, including executing any necessary agreements, to appropriate funding from the funding source account 101-287.000-963.000 to Genesee Conservation District (Genesee Soil & Water Conservation) for the cost of providing professional services needed to evaluate trees that are impacting sidewalks in the City of Flint in an amount not to exceed \$200,000.00. Based on review and validation of the appropriate fund use by the City’s compliance firm, implementation of these funds will be consistent and compliant with US Department of Treasury requirements and previously approved authorizations.

FOR THE CITY OF FLINT:

CLYDE D EDWARDS / A0230
CLYDE D EDWARDS / A0230 (Jun 24, 2024 10:28 EDT)
Clyde Edwards, City Administrator

APPROVED BY CITY COUNCIL:

APPROVED AS TO FORM:

William Kim
William Kim (Jun 24, 2024 09:40 EDT)
William Kim
City Attorney

APPROVED AS TO FINANCE:

Phillip Moore
Phillip Moore (Jun 24, 2024 08:48 EDT)
Phillip Moore
Chief Finance Officer

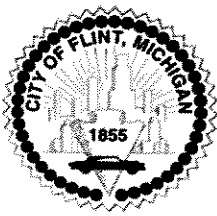

CITY OF FLINT STAFF REVIEW FORM

TODAY'S DATE: June 21, 2024

BID/PROPOSAL#

AGENDA ITEM TITLE: Inspecting trees impacting city sidewalks

PREPARED BY: Kathryn Neumann, Administrative Support Technician

VENDOR NAME: Genesee Conservation District (Genesee Soil & Water Conservation)

BACKGROUND/SUMMARY OF PROPOSED ACTION:

In 2012, the City outsourced the Forestry Division and created a partnership for management of trees with Genesee Conservation District (GCD) through an Memorandum of Understanding. ARPA funding has been allocated to address the city trees impacting sidewalks. The GCD forester/arborist will inspect the trees before damaged sidewalks are replaced. If any tree service is prescribed, the work will commence as required before the sidewalk is replaced.

PREVIOUS ALLOCATIONS (INCLUDE ALL ACCOUNTS USED FOR THIS PURPOSE)/ PROVIDE RESOLUTION OR CONTRACT INFORMATION THAT APPLIES

The City of Flint has allocated \$50,000 each year since 2012 to Genesee Conservation District for the management of trees. Account 202 and 203-449.215-801.000 are both used.

POSSIBLE BENEFIT TO THE CITY OF FLINT (RESIDENTS AND/OR CITY OPERATIONS) INCLUDE PARTNERSHIPS AND COLLABORATIONS:

These inspections and management of trees will mean safer trees and safer sidewalks for the citizens of Flint. The City of Flint has collaborated with Genesee Conservation District for over a decade.

FINANCIAL IMPLICATIONS:

ARPA funding has been allocated for the trees that are severely impacting sidewalks.

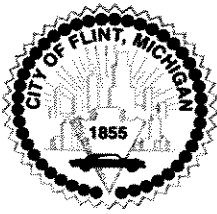

CITY OF FLINT STAFF REVIEW FORM

BUDGETED EXPENDITURE? YES NO IF NO, PLEASE EXPLAIN:

Dept.	Name of Account	Account Number	Grant Code	Amount
DPW	Professional Services	101-449.217-801.000		\$200,000.00
FY25/26 GRAND TOTAL				\$ 200,000.00

PRE-ENCUMBERED? YES NO REQUISITION NO: 240008681

ACCOUNTING APPROVAL: Kathryn Neumann
Kathryn Neumann (Jun 21, 2024 07:01 EDT) Date: _____

WILL YOUR DEPARTMENT NEED A CONTRACT? YES NO

WHEN APPLICABLE, IF MORE THAN ONE (1) YEAR, PLEASE ESTIMATE TOTAL AMOUNT FOR EACH BUDGET YEAR: *(This will depend on the term of the bid proposal)*

BUDGET YEAR 1 \$200,000.00

BUDGET YEAR 2

BUDGET YEAR 3

OTHER IMPLICATIONS *(i.e., collective bargaining)*:

STAFF RECOMMENDATION: *(PLEASE SELECT)*: **APPROVED** **NOT APPROVED**

DEPARTMENT HEAD SIGNATURE: _____
Rodney McGaha
Rodney McGaha (Jun 21, 2024 07:11 EDT)
(Rodney McGaha, Director of Transportation)

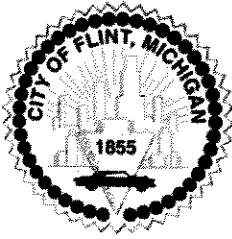

RESOLUTION NO.: 240286

PRESENTED: 7-17-2024

ADOPTED: _____

BY THE CITY ADMINISTRATOR:

RESOLUTION TO NATIONAL COOPERATIVE LEASING FOR EQUIPMENT LEASES

WHEREAS, The Fleet Services Division leases vehicles as part of the fleet maintenance & replacement program; the Fleet Services Division currently has a lease-purchase agreement with Lease Servicing Center, Inc. dba National Cooperative Leasing (NCL) for seven (7) 2019 International tandem axle plow trucks.

WHEREAS, the Fleet Services Division recommends the FY2025 annual lease payment to Lease Servicing Center, Inc. dba NCL for \$272,943.79.

Funding is to come from the following account(s):

Account Number	Account Name/ Grant Code	Amount
661-229.000-940.000	RENTALS	\$272,943.79
	FY2024 TOTAL	\$272,943.79

IT IS RESOLVED, that the Division of Purchases & Supplies is hereby authorized to issue a Purchase Order to Lease Servicing Center, Inc. dba NCL to provide seven (7) leased 2019 International plow trucks for FY25 (07/01/24-06/30/25) in an amount not-to-exceed \$272,943.79

APPROVED AS TO FORM:

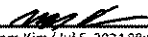
William Kim (Jul 5, 2024 08:02 EDT)

William Kim, City Attorney

APPROVED AS TO FINANCE:

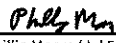
Phillip Moore (Jul 5, 2024 07:35 EDT)

Phillip Moore, Chief Financial Officer

FOR THE CITY OF FLINT:

CLYDE D EDWARDS / A0246
CLYDE D EDWARDS / A0246 (Jul 8, 2024 11:38 EDT)

Clyde Edwards, City Administrator

APPROVED BY CITY COUNCIL:

APPROVED AS TO PURCHASING:



Lauren Rowley, Purchasing Manager

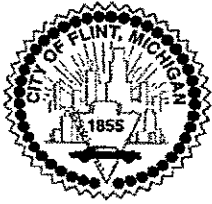

CITY OF FLINT STAFF REVIEW FORM

TODAY'S DATE: 6/25/2024

BID/PROPOSAL#

AGENDA ITEM TITLE: *Lease Payment for Seven (7) Plow Trucks*

PREPARED BY: *Christine Tagg, Fleet Services*

VENDOR NAME: *Lease Servicing Center*

BACKGROUND/SUMMARY OF PROPOSED ACTION:

Fleet Services is requesting a purchase order be issued for FY25 in the amount of \$272,943.79 for the sixth (6th) lease payment of the 6-year lease on seven (7) International HV607 plow trucks originally purchased through the MIDeal vendor/dealer Tri County International Trucks, Inc.

PREVIOUS ALLOCATIONS (INCLUDE ALL ACCOUNTS USED FOR THIS PURPOSE)/ PROVIDE RESOLUTION OR CONTRACT INFORMATION THAT APPLIES

\$278,436.65 in FY20, \$272,943.79 in FY21, \$272,943.79 in FY22, \$272,943.79 in FY23, \$272,943.79 in FY24
Fleet GL 661-229.000-940.000 - Rentals
Original Council Resolution #190417
National Cooperative Leasing Sourcewell Contract #032615-NCL

POSSIBLE BENEFIT TO THE CITY OF FLINT (RESIDENTS AND/OR CITY OPERATIONS) INCLUDE PARTNERSHIPS AND COLLABORATIONS:

Continued maintenance of City roadways for the safety and convenience of Residents and Businesses



CITY OF FLINT STAFF REVIEW FORM

FINANCIAL IMPLICATIONS:

\$272,943.79 in FY25
This is the final lease payment (6 of 6).

BUDGETED EXPENDITURE? YES NO IF NO, PLEASE EXPLAIN:

Dept.	Name of Account	Account Number	Grant Code	Amount
3331	Rentals	661-229.000-940.000		\$272,943.79
FY25 GRAND TOTAL				\$272,943.79

PRE-ENCUMBERED? YES NO REQUISITION NO: 250008772

ACCOUNTING APPROVAL: Christine Tagg
Christine Tagg (Jun 25, 2024 12:13 EDT) Date: June 25, 2024

WILL YOUR DEPARTMENT NEED A CONTRACT? YES NO

WHEN APPLICABLE, IF MORE THAN ONE (1) YEAR, PLEASE ESTIMATE TOTAL AMOUNT FOR EACH BUDGET YEAR: *(This will depend on the term of the bid proposal)*

BUDGET YEAR 1 \$272,943.79

BUDGET YEAR 2

BUDGET YEAR 3

OTHER IMPLICATIONS *(i.e., collective bargaining)*:

STAFF RECOMMENDATION: (PLEASE SELECT): APPROVED NOT APPROVED

DEPARTMENT HEAD SIGNATURE: Marquita Blair
Marquita Blair (Jun 25, 2024 12:30 EDT)
(Marquita Blair, Fleet Administrator)



230267

RESOLUTION NO.: _____

PRESENTED: AUG - 9 2023

ADOPTED: AUG 14 2023

BY THE CITY ADMINISTRATOR:

RESOLUTION TO NATIONAL COOPERATIVE LEASING FOR EQUIPMENT LEASES

WHEREAS, The Fleet Services Division leases vehicles as part of the fleet maintenance & replacement program; the Fleet Services Division currently has a lease-purchase agreement with Lease Servicing Center, Inc. dba National Cooperative Leasing (NCL) for seven (7) 2019 International tandem axle plow trucks.

WHEREAS, the Fleet Services Division recommends the FY2024 annual lease payment to Lease Servicing Center, Inc. dba NCL for \$272,943.79.

Funding is to come from the following account(s):

Account Number	Account Name/ Grant Code	Amount
661-229.000-940.000	RENTALS	\$272,943.79
	FY2024 TOTAL	\$272,943.79

IT IS RESOLVED, that the Division of Purchases & Supplies is hereby authorized to issue a Purchase Order to Lease Servicing Center, Inc. dba NCL to provide seven (7) leased 2019 International plow trucks for FY24 (07/01/23-06/30/24) in an amount not-to-exceed \$272,943.79

APPROVED AS TO FORM:

William Kim (Jul 17, 2023 17:06 EDT)

William Kim, City Attorney

APPROVED AS TO FINANCE:

Jane Mager (Jul 18, 2023 08:49 EDT)

Jane Mager, Acting Chief Financial Officer

FOR THE CITY OF FLINT:

CLYDE D EDWARDS (Jul 18, 2023 11:24 EDT)

Clyde Edwards, City Administrator

APPROVED BY CITY COUNCIL:



APPROVED AS TO PURCHASING:



Christopher Mumby, Interim Purchasing Manager



June 19, 2019

City of Flint, MI

Re: Municipal Lease/Purchase Financing Proposal

Dear Sir or Madam:

Lease Servicing Center, Inc. dba National Cooperative Leasing ("NCL") is pleased to propose to the City of Flint, MI the following tax-exempt Lease/purchase transaction as outlined below. Under this transaction, the City of Flint, MI would enter into a municipal Lease/purchase agreement with NCL for the purpose of acquiring a 2020 HV607. This transaction is subject to formal review and approval by both the Lessor and Lessee.

LESSEE:	City of Flint, MI
LESSOR:	Lease Servicing Center, Inc. dba National Cooperative Leasing & it's assigns
EQUIPMENT:	2020 HV607
EQUIPMENT COST:	\$213,115.00
DOWN-PAYMENT:	\$0
AMOUNT FINANCED:	<u>\$213,115.00</u>
TERM:	<u>6 Years</u>
ANNUAL LEASE PAYMENTS:	\$ 39,740.95
FIRST PAYMENT DUE:	At Lease Commencement
PURCHASE OPTION:	\$1.00
PRICING:	The Rates and Payments outlined above are locked, provided this proposal is accepted by the Lessee by June 30, 2019 and the transaction closes/funds prior to July 31, 2019. After these days, the final Rate and Payments shall be adjusted commensurately with market rates in effect at the time of funding and shall be fixed for the entire lease term.
DOCUMENTATION FEE:	\$250 paid to Lessor at closing

DOCUMENTATION:

Lessor shall provide all of the documentation necessary to close this transaction. This documentation shall be governed by the laws of the State of lessee.

TITLE / INSURANCE:

Lessee shall retain title to the equipment during the lease term. Lessor shall be granted a perfected security interest in the equipment and the Lessee shall keep the equipment free from any/all liens or encumbrances during the term. Lessee shall provide adequate loss and liability insurance coverage, naming Lessor as additional insured and loss-payee.

TAX STATUS:

Interest under the Financing will be tax-exempt and shall be designated by Lessee as a Qualified Tax Exempt Obligation pursuant to Section 265(b)(3) of the IRS Code.

**SOURCEWELL CONTRACT:
#032615-NCL**

NCL has been competitively bid and awarded a contract through Sourcewell (Formerly NJPA). NCL's Sourcewell Contract # is 032615-NCL.

We appreciate this opportunity to offer an NCL Financing Solution. Please do not hesitate to contact me if you have any questions at (866) 763-7600. Acceptance of this proposal is required prior to credit underwriting by NCL. Upon acceptance of this proposal, please scan and e-mail to my attention. Thank you again.

Sincerely,

Jake Ost -(866) 763-7600

jost@lscfinancial.com

ACCEPTANCE

As a duly authorized agent of the City of Flint, MI, I hereby accept the terms of this proposal as outlined above and intend to close this financing with NCL, subject to final approval.

ACCEPTED: _____ DATE: _____

NAME: _____ TITLE: _____

PHONE: _____

WE ARE PROVIDING THE INFORMATION CONTAINED HEREIN FOR INFORMATIONAL PURPOSES ONLY IN CONNECTION WITH POTENTIAL ARMS-LENGTH COMMERCIAL BANKING TRANSACTIONS. IN PROVIDING THIS INFORMATION, WE ARE ACTING FOR OUR OWN INTEREST AND HAVE FINANCIAL AND OTHER INTERESTS THAT DIFFER FROM YOURS. WE ARE NOT ACTING AS A MUNICIPAL ADVISOR OR FINANCIAL ADVISOR TO YOU, AND HAVE NO FIDUCIARY DUTY TO YOU OR ANY OTHER PERSON PURSUANT TO SECTION 15B OF THE SECURITIES EXCHANGE ACT OF 1934. THE INFORMATION CONTAINED IN THIS DOCUMENT IS NOT INTENDED TO BE AND SHOULD NOT BE CONSTRUED AS "ADVICE" WITHIN THE MEANING OF SECTION 15B OF THE SECURITIES EXCHANGE ACT OF 1934 AND THE MUNICIPAL ADVISOR RULES OF THE SEC. WE ARE NOT RECOMMENDING THAT YOU TAKE AN ACTION WITH RESPECT TO THE INFORMATION CONTAINED HEREIN. BEFORE ACTING ON THIS INFORMATION, YOU SHOULD DISCUSS IT WITH YOUR OWN FINANCIAL AND/OR MUNICIPAL, LEGAL, ACCOUNTING, TAX AND OTHER ADVISORS AS YOU DEEM APPROPRIATE. IF YOU WOULD LIKE A MUNICIPAL ADVISOR THAT HAS LEGAL FIDUCIARY DUTIES TO YOU, THEN YOU ARE FREE TO ENGAGE A MUNICIPAL ADVISOR TO SERVE IN THAT CAPACITY.

\$ 213,115

June 03, 2019

INTERNATIONAL*

9' WING, PRE-WET

Prepared For:
CITY OF FLINT
Mike Rule
DEPARTMENT OF PURCH.
FLINT, MI 48502-
(810)766 - 7499
Reference ID: Body Options1&2

Presented By:
TRI COUNTY INTL TRUCKS
Jeremy Kast
3001 E HIGH ST
JACKSON MI 49203
(517)783-2721

Tri County International Trucks, Inc./State of Michigan DTMB Contract 071B6600122, Specification #3958 0173D for a new 2019 MY International HV607 Truck Chassis per this proposal. Pricing includes all user specified option equipment costs and available discounts in effect as of date listed. Please note that the afforded pricing includes a 1% fee paid to the state of Michigan as required under this contract. Additional surcharge requirements as issued by the manufacturer may be applicable in the future

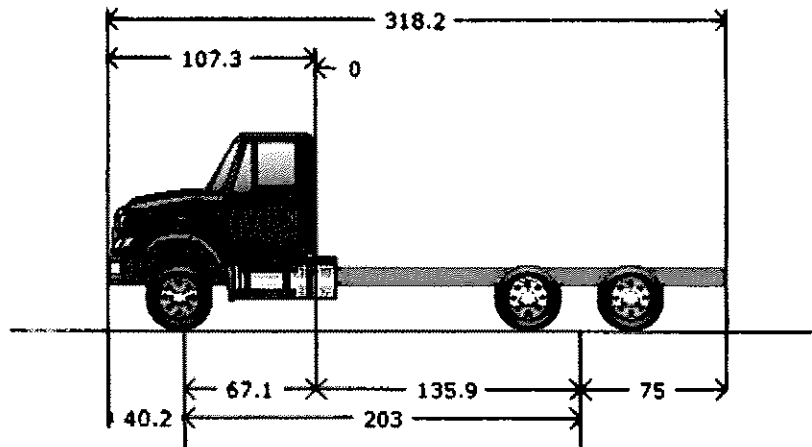

Streets

**Model Profile
2020 HV607 SBA (HV607)**

- AXLE CONFIG:** 6X4
- APPLICATION:** Construction Dump
- MISSION:** Requested GVWR: 52000. Calc. GVWR: 56000
Calc. Start / Grade Ability: 31.42% / 2.01% @ 55 MPH
Calc. Geared Speed: 70.6 MPH
- DIMENSION:** Wheelbase: 203.00, CA: 135.90, Axle to Frame: 75.00
- ENGINE, DIESEL:** {Cummins L9 330} EPA 2017, 330HP @ 2000 RPM, 1000 lb-ft Torque @ 1400 RPM, 2200 RPM Governed Speed, 330 Peak HP (Max)
- TRANSMISSION, AUTOMATIC:** {Allison 3500 RDS} 5th Generation Controls, Wide Ratio, 6-Speed with Double Overdrive, with PTO Provision, Less Retarder, Includes Oil Level Sensor, with 80,000-lb GVW and GCW Max, On/Off Highway
- CLUTCH:** Omit Item (Clutch & Control)
- AXLE, FRONT NON-DRIVING:** {Meritor MFS-16-143A} Wide Track, I-Beam Type, 16,000-lb Capacity
- AXLE, REAR, TANDEM:** {Meritor MT-40-14X-4DCR} Single Reduction, 40,000-lb Capacity, w/.433"(11mm) Wall Housing Thickness, Driver Controlled Locking Differential in Forward-Rear and Rear-Rear Axle, R Wheel Ends Gear Ratio: 5.86
- CAB:** Conventional, Day Cab
- TIRE, FRONT:** (2) 315/80R22.5 Load Range L HSC1 (CONTINENTAL), 484 rev/mile, 68 MPH, All-Position
- TIRE, REAR:** (8) 11R22.5 Load Range H HDR2 (CONTINENTAL), 491 rev/mile, 75 MPH, Drive
- SUSPENSION, REAR, TANDEM:** {Hendrickson HMX-400-52} Walking Beam, 40,000-lb Capacity, 52" Axle Spacing, Rubber Springs, with Transverse Torque Rods, Rubber End Bushings
- FRAME REINFORCEMENT:** Outer "C" Channel, Heat Treated Alloy Steel (120,000 PSI Yield); 10.813" x 3.892" x 0.312"; (274.6mm x 98.9mm x 8.0mm); 480.0" (12192mm) Maximum OAL

INTERNATIONAL®

June 03, 2019

PAINT:

Cab schematic 100WL
Location 1: 2303, Red (Std)
Chassis schematic N/A

<u>Code</u>	<u>Description</u>	<u>F/R Wt</u> (lbs)	<u>Tot Wt</u> (lbs)
HV60700	Base Chassis, Model HV607 SBA with 203.00 Wheelbase, 135.90 CA, and 75.00 Axle to Frame.	6413/3469	9882
1570	TOW HOOK, FRONT (2) Frame Mounted	8/0	8
1572	TOW HOOK, REAR (2)	0/10	10
1AND	AXLE CONFIGURATION {Navistar} 6x4	0/0	0
	<u>Notes</u> : Pricing may change if axle configuration is changed.		
1CBU	FRAME RAILS Heat Treated Alloy Steel (120,000 PSI Yield); 10.125" x 3.580" x 0.312" (257.2mm x 90.9mm x 8.0mm); 480.0" (12192) Maximum OAL	46/250	296
1GBP	FRAME REINFORCEMENT Outer "C" Channel, Heat Treated Alloy Steel (120,000 PSI Yield); 10.813" x 3.892" x 0.312"; (274.6mm x 98.9mm x 8.0mm); 480.0" (12192mm) Maximum OAL	414/592	1006
1LLK	BUMPER, FRONT Omit Item	-83/13	-70
1WDT	FRAME EXTENSION, FRONT Integral; 20" In Front of Grille, with Outer "C" Channel Reinforcement	161/-15	146
1WGX	WHEELBASE RANGE 169" (430cm) Through and Including 219" (555cm)	0/0	0
2ARU	AXLE, FRONT NON-DRIVING {Meritor MFS-16-143A} Wide Track, I-Beam Type, 16,000-lb Capacity	148/0	148
3ADE	SUSPENSION, FRONT, SPRING Parabolic Taper Leaf, Shackle Type, 16,000-lb Capacity, with Shock Absorbers	44/0	44
4091	BRAKE SYSTEM, AIR Dual System for Straight Truck Applications	0/0	0
	<u>Includes</u> : BRAKE LINES Color and Size Coded Nylon : DRAIN VALVE Twist-Type : GAUGE, AIR PRESSURE (2) Air 1 and Air 2 Gauges; Located in Instrument Cluster : PARKING BRAKE CONTROL Yellow Knob, Located on Instrument Panel : QUICK RELEASE VALVE On Rear Axle for Spring Brake Release: 1 for 4x2, 2 for 6x4 : SLACK ADJUSTERS, FRONT Automatic (with Air Cam Brakes) : SLACK ADJUSTERS, REAR Automatic (with Air Cam Brakes) : SPRING BRAKE MODULATOR VALVE R-7 for 4x2, SR-7 with relay valve for 6x4/8x6		
4193	BRAKES, FRONT, AIR CAM 16.5" x 6", Includes 24 SqIn Long Stroke Brake Chambers	26/0	26
4619	TRAILER CONNECTIONS Four-Wheel, with Hand Control Valve and Tractor Protection Valve, for Straight Truck	2/0	2
	<u>Notes</u> : When electronic stability control is ordered with trailer connections on a 4x2 truck, please check the operator manual for trailer weight restrictions.		
4677	TRAILER HOSES Glad Hands for Four-Wheel Connections, Temporarily Mounted with Bulkhead Connectors on End of Frame, Includes Additional Hosing and Dummy Glad Hands	1/15	16

Code	Description	F/R Wt	Tot Wt
		(lbs)	(lbs)
4732	DRAIN VALVE {Berg} with Pull Chain, for Air Tank	0/0	0
4AZA	AIR BRAKE ABS {Bendix AntiLock Brake System} Full Vehicle Wheel Control System (4-Channel)	0/0	0
4EBD	AIR DRYER {Wabco System Saver 1200} with Heater	8/3	11
4EXU	BRAKE CHAMBERS, REAR AXLE {Bendix EverSure} 30/30 Spring Brake	0/78	78
4EXV	BRAKE CHAMBERS, FRONT AXLE {Bendix} 24 SqIn	18/0	18
4LAA	SLACK ADJUSTERS, FRONT {Haldex} Automatic	0/0	0
4LGA	SLACK ADJUSTERS, REAR {Haldex} Automatic	0/0	0
4LGR	BRAKE ATTACHMENT Stainless Steel Slack Adjuster Pins/Cotter Pins on Front and Rear	0/0	0
4NDB	BRAKES, REAR, AIR CAM S-Cam; 16.5" x 7.0"; Includes 30/30 Sq.In. Long Stroke Brake Chamber and Spring Actuated Parking Brake	0/52	52
4SPA	AIR COMPRESSOR {Cummins} 18.7 CFM	0/0	0
4VHZ	AIR TANK LOCATION (2) Mounted Under Cab, Outside Left Rail, on Step Bracket, with Ground Clearance	0/0	0
4VKC	AIR DRYER LOCATION Mounted Inside Left Rail, Back of Cab	15/6	21
5710	STEERING COLUMN Tilting and Telescoping	17/2	19
5CAW	STEERING WHEEL 4-Spoke; 18" Dia., Black	0/0	0
5PTB	STEERING GEAR (2) {Sheppard M100/M80} Dual Power	59/-4	55
7BEU	AFTERTREATMENT COVER Aluminum	9/2	11
7BLG	EXHAUST SYSTEM Single, Horizontal Aftertreatment Device, Frame Mounted Right Side Under Cab, Includes Single Vertical Tail Pipe, Frame Mounted Right Side Back of Cab, for Improved Ground Clearance	134/31	165
7WAZ	TAIL PIPE (1) Turnback Type	0/0	0
7WCM	EXHAUST HEIGHT 8' 10"	1/0	1
7WDN	MUFFLER/TAIL PIPE GUARD (1) Aluminum	0/0	0
8000	ELECTRICAL SYSTEM 12-Volt, Standard Equipment	0/0	0

Includes

- : DATA LINK CONNECTOR For Vehicle Programming and Diagnostics In Cab
- : HAZARD SWITCH Push On/Push Off, Located on Instrument Panel to Right of Steering Wheel
- : HEADLIGHT DIMMER SWITCH Integral with Turn Signal Lever
- : PARKING LIGHT Integral with Front Turn Signal and Rear Tail Light
- : STARTER SWITCH Electric, Key Operated
- : STOP, TURN, TAIL & B/U LIGHTS Dual, Rear, Combination with Reflector
- : TURN SIGNAL SWITCH Self-Cancelling for Trucks, Manual Cancelling for Tractors, with Lane Change Feature
- : WINDSHIELD WIPER SWITCH 2-Speed with Wash and Intermittent Feature (5 Pre-Set Delays), Integral with Turn Signal Lever
- : WINDSHIELD WIPERS Single Motor, Electric, Cowl Mounted
- : WIRING, CHASSIS Color Coded and Continuously Numbered

<u>Code</u>	<u>Description</u>	<u>F/R Wt Tot Wt</u>	
		<u>(lbs)</u>	<u>(lbs)</u>
8518	CIGAR LIGHTER Includes Ash Cup	1/0	1
8541	HORN, ELECTRIC (2) Disc Style	1/0	1
8GXD	ALTERNATOR {Leece-Neville AVI160P2013} Brush Type; 12 Volt 160 Amp. Capacity, Pad Mount, with Remote Sense	0/0	0
8HAB	BODY BUILDER WIRING Back of Day Cab at Left Frame or Under Sleeper, Extended or Crew Cab at Left Frame; Includes Sealed Connectors for Tail/Amber Turn/Marker/ Backup/Accessory Power/Ground and Sealed Connector for Stop/Turn	2/0	2
8HAH	ELECTRIC TRAILER BRAKE/LIGHTS Accommodation Package to Rear of Frame; for Combined Trailer Stop, Tail, Turn, Marker Light Circuits; Includes Electric Trailer Brake Accommodation Package with Cab Connections for Mounting Customer Installed Electric Brake Unit, Less Trailer Socket	0/2	2
8MSH	BATTERY SYSTEM {Fleetrite} Maintenance-Free, (4) 12-Volt 2640CCA Total, Top Threaded Stud	59/47	106
8RMP	RADIO AM/FM/WB/Clock/3.5MM Auxiliary Input	4/0	4
8RMV	SPEAKERS (2) 6.5" Dual Cone Mounted in Doors	0/0	0
8THJ	AUXILIARY HARNESS 3.0' for Auxiliary Front Head Lights and Turn Signals for Front Plow Applications	2/0	2
8TKK	TRAILER AUXILIARY FEED CIRCUIT for Electric Trailer Brake Accommodation/Air Trailer ABS; with 30 Amp Fuse and Relay, Controlled by Ignition Switch	1/0	1
8VUJ	BATTERY BOX Steel, with Plastic Cover, 18" Wide, 2-4 Battery Capacity, Mounted Right Side Back of Cab	-34/11	-23
8WBW	JUMP START STUD Remote Mounted	2/0	2
8WGL	WINDSHIELD WIPER SPD CONTROL Force Wipers to Slowest Intermittent Speed When Park Brake Set and Wipers Left on for a Predetermined Time	0/0	0
8WPH	CLEARANCE/MARKER LIGHTS (5) {Truck Lite} Amber LED Lights, Flush Mounted on Cab or Sunshade	0/0	0
8WPZ	TEST EXTERIOR LIGHTS Pre-Trip Inspection will Cycle all Exterior Lamps Except Back-up Lights	0/0	0
8WRB	HEADLIGHTS ON W/WIPERS Headlights Will Automatically Turn on if Windshield Wipers are turned on	0/0	0
8WWJ	INDICATOR, LOW COOLANT LEVEL with Audible Alarm	0/0	0
8WXB	HEADLIGHT WARNING BUZZER Sounds When Head Light Switch is on and Ignition Switch is in "Off" Position	0/0	0
8WXG	STARTING MOTOR {Mitsubishi Electric Automotive America 105P} 12-Volt, with Soft-Start	10/0	10
8XAH	CIRCUIT BREAKERS Manual-Reset (Main Panel) SAE Type III with Trip Indicators, Replaces All Fuses	0/0	0
8XGT	TURN SIGNALS, FRONT Includes LED Side Turn Lights Mounted on Fender	0/0	0

<u>Code</u>	<u>Description</u>	<u>F/R Wt Tot Wt</u>	
		(lbs)	(lbs)
8XHN	HORN, AIR Black, Single Trumpet, with Lanyard Pull Cord	0/0	0
9AAB	LOGOS EXTERIOR Model Badges	0/0	0
9AAE	LOGOS EXTERIOR, ENGINE Badges	0/0	0
9HAN	INSULATION, UNDER HOOD for Sound Abatement	10/0	10
9HBM	GRILLE Stationary, Chrome	0/0	0
9HBN	INSULATION, SPLASH PANELS for Sound Abatement	2/0	2
9WAC	BUG SCREEN Mounted Behind Grille	5/0	5
9WBC	FRONT END Tilting, Fiberglass, with Three Piece Construction, for WorkStar/HV	0/0	0
10022	CHASSIS COATING Corrosion Resistant E-Coat Primer Coating for Reinforced Frame Rails	0/0	0
10060	PAINT SCHEMATIC, PT-1 Single Color, Design 100	0/0	0
	<u>Includes</u> : PAINT SCHEMATIC ID LETTERS "WL"		
10761	PAINT TYPE Base Coat/Clear Coat, 1-2 Tone	0/0	0
10BAE	LABEL, DEF "DEF ONLY"	0/0	0
10SLV	PROMOTIONAL PACKAGE Government Silver Package	0/0	0
10WCY	SAFETY TRIANGLES	6/0	6
11001	CLUTCH Omit Item (Clutch & Control)	-56/-7	-63
12703	ANTI-FREEZE Red, Extended Life Coolant; To -40 Degrees F/ -40 Degrees C, Freeze Protection	0/0	0
12849	BLOCK HEATER, ENGINE 120V/1000W, for Cummins ISB/B6.7/ISL/L9 Engines	3/0	3
	<u>Includes</u> : BLOCK HEATER SOCKET Receptacle Type; Mounted below Drivers Door		
12851	PTO EFFECTS, ENGINE FRONT Less PTO Unit, Includes Adapter Plate on Engine Front Mounted	10/0	10
12EHV	ENGINE, DIESEL {Cummins L9 330} EPA 2017, 330HP @ 2000 RPM, 1000 lb-ft Torque @ 1400 RPM, 2200 RPM Governed Speed, 330 Peak HP (Max)	581/-17	564
12THT	FAN DRIVE {Horton Drivemaster} Direct Drive Type, Two Speed with Residual Torque Device for Disengaged Fan Speed	0/0	0
	<u>Includes</u> : FAN Nylon		
12UWZ	RADIATOR Cross Flow, Series System; 1228 SqIn Aluminum Radiator Core with Internal Water to Oil Transmission Cooler and 1167 In Charge Air Cooler	22/-4	18
	<u>Includes</u> : DEAERATION SYSTEM with Surge Tank : HOSE CLAMPS, RADIATOR HOSES Gates Shrink Band Type; Thermoplastic Coolant Hose Clamps		

<u>Code</u>	<u>Description</u>	<u>F/R Wt</u> (lbs)	<u>Tot Wt</u> (lbs)
	: RADIATOR HOSES Premium, Rubber		
12VAG	AIR CLEANER Single Element, with Integral Snow Valve and In-Cab Control	2/0	2
12VGZ	FEDERAL EMISSIONS {Cummins L9} EPA, OBD and GHG Certified for Calendar Year 2019	0/0	0
12VXT	THROTTLE, HAND CONTROL Engine Speed Control; Electronic, Stationary, Variable Speed; Mounted on Steering Wheel	0/0	0
12VYP	ENGINE CONTROL, REMOTE MOUNTED No Provision Furnished for Remote Mounted Engine Control	0/0	0
12WZE	EMISSION COMPLIANCE Federal, Does Not Comply with California Clean Air Idle Regulations	0/0	0
13AVL	TRANSMISSION, AUTOMATIC {Allison 3500 RDS} 5th Generation Controls, Wide Ratio, 6-Speed with Double Overdrive, with PTO Provision, Less Retarder, Includes Oil Level Sensor, with 80,000-lb GVW and GCW Max, On/Off Highway	199/50	249
13WDT	SHIFT CONTROL PARAMETERS {Allison} 3 Speed S1 Secondary Shift Schedule for 5 or 6 Speed Allison Gen4/Gen 5 3000 & 4000 Series Transmissions	0/0	0
13WET	TRANSMISSION SHIFT CONTROL for Column Mounted Stalk Shifter	0/0	0
13WLP	TRANSMISSION OIL Synthetic; 29 thru 42 Pints	0/0	0
13WUC	ALLISON SPARE INPUT/OUTPUT for Rugged Duty Series (RDS); General Purpose Trucks, Construction	0/0	0
13WYH	TRANSMISSION TCM LOCATION Located Inside Cab	0/0	0
13XAN	PTO LOCATION Customer Does Not Intend to Install PTO	0/0	0
14GVN	AXLE, REAR, TANDEM {Meritor MT-40-14X-4DCR} Single Reduction, 40,000-lb Capacity, w/.433"(11mm) Wall Housing Thickness, Driver Controlled Locking Differential in Forward-Rear and Rear-Rear Axle, R Wheel Ends . Gear Ratio: 5.86	0/2117	2117
14UMB	SUSPENSION, REAR, TANDEM {Hendrickson HMX-400-52} Walking Beam, 40,000-lb Capacity, 52" Axle Spacing, Rubber Springs, with Transverse Torque Rods, Rubber End Bushings	0/518	518
14WBV	SHOCK ABSORBERS, REAR (4) for Hendrickson HMX Suspension Only, Mounted from Frame to Beam	0/31	31
14WMJ	AXLE, REAR, LUBE {EmGard FE-75W-90} Synthetic Oil; 50 thru 64.99 Pints	0/0	0
15LMN	FUEL/WATER SEPARATOR {Racor 400 Series,} 12 VDC Electric Heater, Includes Pre-Heater, with Primer Pump, Includes Water-in-Fuel Sensor	0/0	0
15LMU	LOCATION FUEL/WATER SEPARATOR Mounted Outside Left Rail, 8" Back of Cab	0/0	0
15SSC	FUEL TANK Temporary, Top Draw, Non-Polished Aluminum, D-Style, 16" Tank Depth, 50 US Gal (189L), Mounted Left Side, Back of Cab	24/2	26
15WDG	DEF TANK 7 US Gal (26L) Capacity, Frame Mounted Outside Left Rail, Under Cab	0/0	0

Code	Description	F/R Wt Tot Wt	
		(lbs)	(lbs)
16030	CAB Conventional, Day Cab	0/0	0
16BAM	AIR CONDITIONER with Integral Heater & Defroster	56/0	56
16GDC	GAUGE CLUSTER Base Level; English with English Speedometer and Tachometer, for Air Brake Chassis, Includes Engine Coolant Temperature, Primary and Secondary Air Pressure, Fuel and DEF Gauges, Oil Pressure Gauge, Includes 3 Inch Monochromatic Text Display	0/0	0
16HGH	GAUGE, OIL TEMP, AUTO TRANS for Allison Transmission	1/0	1
16HKT	IP CLUSTER DISPLAY On Board Diagnostics Display of Fault Codes in Gauge Cluster	0/0	0
16JNV	SEAT, DRIVER {National 2000} Air Suspension, High Back with Integral Headrest, Cloth, Isolator, 1 Chamber Lumbar, 2 Position Front Cushion Adjust, -3 to +14 Degree Back Angle Adjust	29/10	39
16SMM	SEAT, PASSENGER {National} Non Suspension, High Back, Fixed Back, Integral Headrest, Cloth	17/6	23
16SNL	MIRRORS (2) Black Heads, Brackets and Arms, 7.55" x 14.1" Flat Glass, 7.48" x 6.77" Convex Glass Both Sides	0/0	0
16SNW	MIRROR, CONVEX, LOOK DOWN Right Side, Black, 6" x 10 1/4"	0/0	0
16VKB	CAB INTERIOR TRIM Classic, for Day Cab	0/0	0
	<u>Includes</u> : CONSOLE, OVERHEAD Molded Plastic with Dual Storage Pockets, Retainer Nets and CB Radio Pocket; Located Above Driver and Passenger : DOME LIGHT, CAB Door Activated and Push On-Off at Light Lens, Timed Theater Dimming, Integral to Overhead Console, Center Mounted : SUN VISOR (2) Padded Vinyl; 2 Moveable (Front-to-Side) Primary Visors, Driver Side with Toll Ticket Strap		
16WEE	CAB SOUND INSULATION Includes Dash Insulator and Engine Cover Insulator	12/0	12
16WSK	CAB REAR SUSPENSION Air Bag Type	0/0	0
16XCK	WINDOW, MANUAL (2) and Manual Door Locks, Left and Right Doors	0/0	0
16XJN	INSTRUMENT PANEL Flat Panel	0/0	0
16ZBT	ACCESS, CAB Steel, Driver & Passenger Sides, Two Steps per Door, for use with Day Cab and Extended Cab	0/0	0
27DUL	WHEELS, FRONT {Accuride 29300} DISC; 22.5x9.00 Rims, Powder Coat Steel, 5-Hand Hole, 10-Stud, 285.75mm BC, Hub-Piloted, Flanged Nut, with Steel Hubs	72/0	72
28DTT	WHEELS, REAR {Accuride 28828} DUAL DISC; 22.5x8.25 Rims, Powder Coat Steel, 2-Hand Hole, 10-Stud, 285.75mm BC, Hub-Piloted, Flanged Nut, with .472" Thick Increased Capacity Disc and with Steel Hubs	0/56	56
29WLK	WHEEL BEARING, FRONT, LUBE {EmGard FE-75W-90} Synthetic Oil	0/0	0
60AAG	BDY INTG, REMOTE POWER MODULE Mounted Inside Cab Behind Driver Seat, Up to 6 Outputs & 6 Inputs, Max 20 amp per Channel, Max 80 amp Total; Includes 1 Switch Pack with Latched Switches	0/0	0

<u>Code</u>	<u>Description</u>	<u>F/R Wt</u> (lbs)	<u>Tot Wt</u> (lbs)
7382135423	(8) TIRE, REAR 11R22.5 Load Range H HDR2 (CONTINENTAL), 491 rev/mile, 75 MPH, Drive	0/120	120
7792545419	(2) TIRE, FRONT 315/80R22.5 Load Range L HSC1 (CONTINENTAL), 484 rev/mile, 68 MPH, All-Position	82/0	82
	Cab schematic 100WL		
	Location 1: 2303, Red (Std)		
	Chassis schematic N/A		
	Services Section:		
40128	WARRANTY Standard for HV507, HV508, HV607 Models, Effective with Vehicles Built July 1, 2017 or Later, CTS-2025A	0/0	0
	Total Component Weight:	8566/7446	16012
1	Body and Equipment install by Truck & Trailer Specialties with Option #1 and #2 per quote dated 5-30-2019	0/0	0
	Total Body Allied:	0/0	0
	D.O.T. Inspection, Safety Kit, Mud Flaps	0/0	0
	1% MIDEAL Fee Paid to State of MI Under MIDEAL Purchasing Program Requirements	0/0	0
	Total Goods Purchased:	0/0	0

The weight calculations included in this proposal are an estimate of future vehicle weight. The actual weight as manufactured may be different from the estimated weight. Navistar, Inc. shall not be liable for any consequences resulting from any differences between the estimated weight of a vehicle and the actual weight.

(US DOLLAR)

<u>Description</u>	<u>Price</u>
Total Factory List Price Including Options:	\$145,463.00
Total Goods Purchased:	\$1,235.74
Total Preparation And Delivery:	\$190.00
Total Freight:	\$2,250.00
Total Factory List Price Including Freight:	\$149,138.74
Less Customer Allowance:	(\$54,655.74)
Total Vehicle Price:	\$94,483.00
Total Body/Allied Equipment:	\$118,617.00 - 9' wing, pre-wet
Total Sale Price:	\$213,100.00
Total Per Vehicle Sales Price:	\$213,100.00
Total Net Sales Excluding Taxes:	\$213,100.00
Michigan Title Fee	\$15.00
Total License, Title:	\$15.00
Net Sales Price:	\$213,115.00

Payment for the chassis is due upon delivery of the cab/chassis to the end user or body company; which ever occurs first. If payment is not received in a timely manner additional floorplan(interest) costs may be charged to the end-user customer.

Please make all purchase orders and checks payable to:
Tri-County International Trucks, Inc.
5701 Wyoming Ave.
Dearborn, MI 48126

Please review this proposal very carefully. Your signature below indicates that you accept the specifications and payment terms contained herein as written and that you are able to approve said specifications for order and payment terms. Please include this proposal number on all correspondence and purchase orders. This proposal contains in its entirety our offer to you for this purchase at the given dollar amount. No other offers, spec additions, warranties, or other additional items are made or implied. Other additional items may be available; contact your local dealer representative for further details.

Approved by Seller:

Accepted by Purchaser:

Official Title and Date

Firm or Business Name

Authorized Signature

Authorized Signature and Date

TRI COUNTY INTL TRUCKS
3001 E HIGH ST
JACKSON MI 49203
(517)783-2721

This proposal is not binding upon the seller without Seller's Authorized Signature

Official Title and Date

The TOPS FET calculation is an estimate for reference purposes only. The seller or retailer is responsible for calculating and reporting/paying appropriate FET to the IRS.

The limited warranties applicable to the vehicles described herein are Navistar, Inc.'s standard printed warranties which are incorporated herein by reference and to which you have been provided a copy and hereby agree to their terms and conditions.

TRUCK & TRAILER Specialties, Inc.

900 Grand Oaks Drive | Howell, MI 48843 | www.ttspec.com | ph: (517) 290-9876 | fx: (517) 552-3666

May 30, 2019

City of Flint
702 West 12th Street, Flint, MI 48502
Attention: Mike Rule, Fleet Superintendent

Equipment Quotation

Install Monroe 14' model RDS-168-96-56 (Radius Dump Spreader) Body including the following:

Body capacity 10 yards water level and 12 yards with sideboards
Overall length is 168", outside width is 96" and overall side height is 56"
Tailgate height is 50", side height is 44" and 50" at the front
Body shell is constructed of unpainted 3/16" 201 stainless steel
Body longitudinals are ¼" 201 stainless steel
Air-operated tailgate release
Conveyor trough is 34" wide
667XH chain with crossbars on every-other link/4.5" centers
Rear tailgate includes a removable rear metering gate and a blank insert
Extended tandem axle fender kit installed integrally to the body of 7 ga 201 stainless steel
Twin Rawson-type 6:1 gear boxes
8-tooth hardened sprockets with 2" drive and idler shafts for the conveyor
Grease extension kit for rear bearings, tailgate pivot arms, front bearings and hoist trunnion
1/2 cabshield constructed of 7 ga 201 stainless steel
Drive motors are each 15 CID
Mudflaps installed in front of and behind drive tires
Backup alarm included
Four (4) oval light holes cut into each rear pillar
Install chassis frame-mounted, removable stainless steel spillshields to collect carry-over of salt
Install 6" hardwood sideboards on body
Install one (1) shovel holder on RDS bulkhead, curbside
Install one (1) fold-down stainless steel ladder mounted on the curbside rear of the body
Install bracket for the license plate on the rear tailgate on the left side
Install RDS-168 trough/floor cover kit, ¼" steel construction, powder-coated Black

Install Rear Spinner Assembly including the following:

Dual, receiver-type tubular mounting
Formed 24" poly spinner disc
Spinner motor includes seal saver
Direction chute on inside of spinner with 3 exterior adjustable deflectors
Construction is type 201 stainless steel

Install Mailhot-type Telescopic Hoist including the following:

Hoist is double-acting and includes nitrated cylinders
Hoist includes oscillating mounting collar and is trunnion-mounted
Hoist is NTEA class 90

Install Roll-Rite Electric Tarp System including the following:

TarpMaster motor/gear box
Mesh tarp cover
Aluminum tarp and 4-spring tension bows with offset elbows

TRUCK & TRAILER *Specialties, Inc.*

900 Grand Oaks Drive | Howell, MI 48843 | www.ttspec.com | ph: (517) 290-9876 | fx: (517) 552-3666

- Aluminum wind deflector
- Install Rexroth A10VO100 Hydraulic Load-Sense Piston Pump including the following:**
 - Pump is front-mounted with 100CC displacement
 - Front crossmember for pump mounting
 - Spicer 1310 driveline
 - 12-volt auto shutdown block
 - Low-oil shutdown valve and override circuit
- Install Rexroth 7m4-12 Load-Sense Hydraulic Valve including the following:**
 - Pressure-compensated flow controls for the following functions:
 - Air section for hoist with 500 PSI A-port load-sense limit DA
 - Air section for scraper up/down with load-sense limit DA
 - Air section for scraper swing DA
 - Air section for front plow up/down DA
 - Air section for front plow swing DA
 - EPC section for conveyor
 - EPC section for spinner
 - Stainless steel pipe for hydraulic lines to rear
 - Stainless steel hydraulic quick couplers for front plow & spinner with dust plugs & caps
- Install TTS Pneu-Logic multi-function single air-operated joystick including the following:**
 - Scraper, plow & hoist operations as well as remote pause/blast buttons on joystick
 - Heads-up display for indicating joystick functions
 - All necessary hoses and fittings
- Install Rexroth CS520 Electric Spreader Controller including the following:**
 - Designed to operate in open-loop, groundspeed orientation, groundspeed-triggered or manual modes including pause & blast features
 - Controller mounted between the seats on a console
 - All necessary hoses and fittings
- Install Monroe Combination Fuel/Hydraulic Oil/Valve Enclosure including the following:**
 - 100 gal fuel capacity, 35 gal oil capacity
 - 7 ga type 201 stainless steel construction
 - Valve enclosure integral to the tank
 - Valve enclosure with a lockable "T" handle latch, contained within driver's side of combo tank
 - Mounting brackets are 4" ship and car channel
 - Ispro solid state fuel gauge sending unit
 - Ball-valve shutoff on supply line and case and fuel ports
 - Tank-mounted return line oil filter
 - 35 gal AW32 hydraulic oil
 - Low oil sending unit
 - Sight/temp indicator gauge
 - Suction strainer
 - Tank labels included
 - Install curbside safety fuel hook mounted on tank
 - Install 3-step egress & platform from streetside fender to combo tank, painted Red to match cab
- Install 29" Husting truck-portion Hitch including the following:**
 - 12" channel front bumper with tapered ends
 - 3" DA lift cylinder with Socatri rod
 - Front tow hooks to be mounted on hitch's kicker legs
 - Plow cushion valve mounted under bumper driver's side
 - All necessary supports and bracing

TRUCK & TRAILER *Specialties, Inc.*

900 Grand Oaks Drive | Howell, MI 48843 | www.ttspec.com | ph: (517) 290-9876 | fx: (517) 552-3666

Install Monroe model MP41R11-ISCT Full Moldboard Trip Reversible Plow including the following:

11' long x 41" high moldboard
3/16" roll-formed moldboard
Six ½" x 4" tapered one-piece flame-cut ribs
2" x 3" x 3/8" top moldboard angle
4" x 4" x 3/4" bottom moldboard angle
Horizontal moldboard brace angles
Dual compression trip spring assemblies
4" x 4" x 3/8" cross-tube support; full-width with 6-point attachment
3-1/2" x 3-1/2" x 1/2" semi-circle; additional angle braces to front push tube
Two, 4" x 10" double-acting power-reverse cylinders with 2" nitrated rods
Cushion valve
Moldboard and pushframe 100% continuously welded
Powder-coated with the moldboard Orange and a Black pushframe
¾" x 8" x 11' one piece top-punch cutting edge
12" x 11' rubber deflector with steel retainer bar, installed
Plow-portion Husting hitch-type lift for 29" Husting hitch
Pair of 48" Orange plastic plow markers
Monroe wrap-around curbguards, both ends
Screw adjustable skid shoes to be mounted on the plow

Install Monroe model 4512 Underbody Scraper including the following:

12' x 20" x 1" moldboard
½" thick hanger board with grease manifold brackets installed
Two, 4" power-reverse cylinder with 2" Socatri rods
Two, 3.5" actuating cylinders with 2" Socatri rods
All cylinders have poly pack seals
1" circle with 5" greaseable center bolt
Circle includes a welded in hardened bushing
2" clevis bosses on power-reverse cylinders
Contoured circle clamps with poly type wear pads
Three reinforced moldboard hinges with gussets
3/8" pipe and hoses for faster scraper actuation
Hinge shaft is 2.5" cold-rolled round stock
Moldboard hinges are constructed of 3/8" wall DOM tubing
Adjustable j-50 relief valve is included
Cushion valve for power reverse circuit is included
Remote lube manifolds and grease lines
Piloted center pin
Bolt-in trunnion caps for canisters
Install Kennametal single insert carbide cutting edges
Install Kennametal carbide curbguard on curbside end of moldboard
Install serrated step on end of moldboard, streetside
Paint Red bands at each end of moldboard to match cab

Install Custom Lighting & Electrical System including the following:

Six (6) SoundOff mPower (mo. EMPC2SMS4) amber/green LED flashers flush-mounted:
Two (2) mounted on plow light brackets (on separate switch)
Two (2) cabshield-mounted front-facing under cabshield
Two (2) cabshield-mounted side-facing at bottom of cabshield
Four-hole, in-pillar 6" oval lights including the following from top down:

TRUCK & TRAILER Specialties, Inc.

900 Grand Oaks Drive | Howell, MI 48843 | www.ttspec.com | ph: (517) 290-9876 | fx: (517) 552-3666

- Two (2) SoundOff LED solid Green flashers in top holes
- Two (2) SoundOff LED STT lights, 2nd from top
- Two (2) SoundOff LED backup lights, 3rd from top
- Two (2) SoundOff LED solid Amber flashers in bottom holes

Truck-Lite snow plow lights on aluminum brackets (mounted height TBD)

One (1) Weldex LED work light at driver-side corner of body to illuminate salt spread pattern

Two (2) Weldex LED work lights one each side to illuminate scraper

LED clearance marker light kit on dump body

No 3-light cluster

Chassis switches six (6) for the following:

Flashers and work lights for scraper & spreader

Pneu-Logic Joystick console switches for the following (ordered L-R):

1. Air Tailgate w/ Safety cap
2. Tarp In/ Tarp Out
3. Low-oil Override/ Pump Shutdown

Heads-up Display indicators in-cab for the following:

Scraper, Plow, Tailgate Open, Low-oil, Body-up, Low-liquid & Pump Shutdown

Betts junction box with sealed wiring mounted at RDS body streetside

Backup alarm

Electric brake controller

All wiring to be soldered, heat-shrunk and in protective loom

Install Flaming River brand 3-minute timed delay battery disconnect and LED red indicator "button" light

Install 3/4" Rear Hitch Assembly including the following:

PH20 20-ton rated pintle hook, multi-drill pattern for adjustable mounting heights (mounted at TBD)

Rear tow hooks mounted outside of frame rails

Heavy-duty D-rings for safety chain

7-way round pin plug

Remount glad hands

Paint Bottom of body, body hinge, body props, front & rear hitch and attaching hardware Black

Minimum full 1-year warranty on parts and labor on all equipment.

Above installed, non-stainless equipment painted: \$95,860.00 ea.

Option #1 Install Monroe Closed-Loop Pre-Wet System including the following:

NEMA weather-tight fiberglass pump enclosure

Hydraulic driven 7 gpm pump assembly with Dickey-john flow meter

5 PSI in-line check valve for nozzles

2 nozzle w/ brass tips and caps

Twin (2) 100 gallon tanks with stainless steel attaching hardware

Includes crossover tube, bulk fill adapter and flush kit

Remote vent tube for each tank

Additional EPC section for pre-wet to valve assembly

Upgrade spreader controller to Rexroth CS530 with 3rd channel for liquid in lieu of Rexroth CS520

Install stainless steel spray bar in auger trough/at spinner assembly for prewet application

Option #1 add: \$5,977.00 ea.

Option #2 Install Monroe 9' Para-Glide Patrol Wing for tandem axle chassis including the following:

TRUCK & TRAILER Specialties, Inc.

900 Grand Oaks Drive | Howell, MI 48843 | www.ttspec.com | ph: (517) 290-9876 | fx: (517) 552-3666

Moldboard inboard shall be 27" and outboard height to be 28"
Both inboard and outboard measurements include the 8" cutting edge installed
Moldboard shall be 3/16" A36 steel
Moldboard includes a 4" x 4" x 3/4" bottom angle
Top of moldboard shall be formed into a 2-3/4" x 1" channel for additional strength
Para-Glide style wing post mounted behind the scraper
Wing post shall be of a trailing link style with 12" of lift and designed to allow the moldboard to float up a minimum of 8-12" when in the plowing position
Banjo plate includes captive design feature
Twin rear-mounted, cushioned push-arms with rear lift cylinder to operate the heel
Push-arms includes bolt-in design and grease zerks for ease of maintenance
Moldboard is powder-coated Orange
D-type rubber bumper stops
Safety chain at rear
5" x 7" rear crosstube for rear wing support
Sequencing valve with hoses and couplers
Install stainless steel light box on the wing moldboard with a SoundOff nForce (mo. ENFSLSRV12) amber/green flasher light pointed rearward and an LED marker light pointed forward
One (1) Weldex LED work light to illuminate wing
5/8" x 8" x 108" reverse-curve steel cutting edge
Install two (2) cast-iron TTWS moldboard shoes
Install one (1) curved carbide curbguard (TTS part# 4191060)
Stainless steel couplers for wing circuits
Add wing indicator light to Heads-Up Display & control button in Pneu-Logic joystick
Additional Air section for wing plow DA to valve assembly
Install LaserLine model GL3000PMC Wing Plow Guidance Laser including the following:
Green "ultra-bright" laser assembly enclosed in weatherproof housing
Heated front window lens to reduce or eliminate icing
Pneumatic air blast mechanism for lens, blasting every 5 seconds
Control switch installed in-cab for laser on/off and air blast on/off
Laser assembly installed on roof of cab

Option #2 add: \$16,780.00 ea.

Option #3 Install Monroe 7' Para-Glide Junior Wing in lieu of Monroe 9' Para-Glide Patrol Wing

Option #3 DEDUCT: \$1,070.00 ea.

Payment Terms: Net 30. Pricing effective for 45 days.

FOB: City of Flint

Delivery: 360 days ARO

Chassis requirements:

136" CT & 204" WB (to be confirmed at time of order)

Highest ground clearance package

6-pack of switches

Exhaust System: Switchback horizontal aftertreatment device, frame-mounted rightside undercab Includes single vertical tailpipe, frame-mounted rightside back-of-cab

Delete OEM front bumper

Front integral frame extension

TRUCK & TRAILER *Specialties, Inc.*

900 Grand Oaks Drive | Howell, MI 48843 | www.ttspec.com | ph: (517) 290-9876 | fx: (517) 552-3666

Front PTO provision
Stationary grille
Plow light/Headlight switch and related OEM wiring
Front & rear tow hooks
7-way trailer wiring to rear for electric brake controller
Temporary fuel tank

Thank you for the opportunity to quote.

Respectfully submitted by,
Jon Luea/Brian Bouwman

GOVERNMENT OBLIGATION CONTRACT

Obligor

City of Flint, Michigan
1101 South Saginaw Street
Flint, Michigan 48502

Obligee

Lease Servicing Center, Inc. dba National Cooperative Leasing
220 22nd Avenue East, Suite 106
Alexandria, Minnesota 56308

Dated as of December 27, 2019

This Government Obligation Contract dated as of the date listed above is between Obligee and Obligor listed directly above. Obligee desires to finance the purchase of the Equipment described in Exhibit A to Obligor and Obligor desires to have Obligee finance the purchase of the Equipment subject to the terms and conditions of this Contract which are set forth below.

I. Definitions

Section 1.01 Definitions. The following terms will have the meanings indicated below unless the context clearly requires otherwise:

"Additional Schedule" refers to the proper execution of additional schedules to Exhibit A and Exhibit B, as well as other exhibits or documents that may be required by the Obligee all of which relate to the financing of additional Equipment.

"Budget Year" means the Obligor's fiscal year.

"Commencement Date" is the date when Obligor's obligation to pay Contract Payments begins.

"Contract" means this Government Obligation Contract and all Exhibits attached hereto, all addenda, modifications, schedules, refinancings, guarantees and all documents relied upon by Obligee prior to execution of this Contract.

"Contract Payments" means the payments Obligor is required to make under this Contract as set forth on Exhibit B.

"Contract Term" means the Original Term and all Renewal Terms.

"Exhibit" includes the Exhibits attached hereto, and any "Additional Schedule", whether now existing or subsequently created.

"Equipment" means all of the items of Equipment listed on Exhibit A and any Additional Schedule, whether now existing or subsequently created, and all replacements, restorations, modifications and improvements.

"Government" as used in the title hereof means a State or a political subdivision of the State within the meaning of Section 103(a) of the Internal Revenue Code of 1986, as amended ("Code"), or a constituted authority or district authorized to issue obligations on behalf of the State or political subdivision of the State within the meaning of Treasury Regulation 1.103-1(b), or a qualified volunteer fire company within the meaning of section 150(e)(1) of the Code.

"Obligee" means the entity originally listed above as Obligee or any of its assignees.

"Obligor" means the entity listed above as Obligor and which is financing the Equipment through Obligee under the provisions of this Contract.

"Original Term" means the period from the Commencement Date until the end of the Budget Year of Obligor.

"Renewal Term" means the annual term which begins at the end of the Original Term and which is simultaneous with Obligor's Budget Year and each succeeding Budget Year for the number of Budget Years necessary to comprise the Contract Term.

"State" means the state which Obligor is located.

II. Obligor Warranties

Section 2.01 Obligor represents, warrants and covenants as follows for the benefit of Obligee or its assignees:

- (a) Obligor is an "issuer of tax exempt obligations" because Obligor is the State or a political subdivision of the State within the meaning of Section 103(a) of the Internal Revenue Code of 1986, as amended, (the "Code") or because Obligor is a constituted authority or district authorized to issue obligations on behalf of the State or political subdivision of the State within the meaning of Treasury Regulation 1.103-1(b), or a qualified volunteer fire company within the meaning of section 150(e)(1) of the Code.
- (b) Obligor has complied with any requirement for a referendum and/or competitive bidding.
- (c) Obligor has complied with all statutory laws and regulations that may be applicable to the execution of this Contract; Obligor, and its officer executing this Contract, are authorized under the Constitution and laws of the State to enter into this Contract and have used and followed all proper procedures of its governing body in executing and delivering this Contract. The officer of Obligor executing this Contract has the authority to execute and deliver this Contract. This Contract constitutes a legal, valid, binding and enforceable obligation of the Obligor in accordance with its terms.
- (d) Obligor shall use the Equipment only for essential, traditional government purposes.
- (e) Should the IRS disallow the tax-exempt status of the interest portion of the Contract Payments as a result of the failure of the Obligor to use the Equipment for governmental purposes, or should the Obligor cease to be an issuer of tax exempt obligations, or should the obligation of Obligor created under this Contract cease to be a tax exempt obligation for any reason, then Obligor shall be required to pay additional sums to the Obligee or its assignees so as to bring the after tax yield on this Contract to the same level as the Obligee or its assignees would attain if the transaction continued to be tax-exempt.
- (f) Obligor will submit to the Secretary of the Treasury an information reporting statement as required by the Code.
- (g) Upon request by Obligee, Obligor will provide Obligee with current financial statements, reports, budgets or other relevant fiscal information.
- (h) Obligor shall retain the Equipment free of any hazardous substances as defined in the Comprehensive Environmental Response, Compensation and Liability Act, 42 U.S.C. 9601 et. seq. as amended and supplemented.
- (i) Obligor hereby warrants the General Fund of the Obligor is the primary source of funds or a backup source of funds from which the Contract Payments will be made.
- (j) Obligor presently intends to continue this Contract for the Original Term and all Renewal Terms as set forth on Exhibit B hereto. The official of Obligor responsible for budget preparation will include in the budget request for each Budget Year the Contract Payments to become due in such Budget Year, and will use all reasonable and lawful means available to secure the appropriation of money for such Budget Year sufficient to pay the Contract Payments coming due therein. Obligor reasonably believes that moneys can and will lawfully be appropriated and made available for this purpose.
- (k) Obligor has selected both the Equipment and the vendor(s) from whom the Equipment is to be purchased upon its own judgment and without reliance on any manufacturer, merchant, vendor or distributor, or agent thereof, of such equipment to the public.
- (l) Obligor owns the Equipment and any additional collateral free and clear of any liens, and Obligor has not and will not, during the Contract Term, create, permit, incur or assume any levies, liens or encumbrances of any kind with respect to the Equipment or any additional collateral except those created by this Contract.
- (m) The outstanding balance of all purchases authorized under Act 99 of 1933, exclusive of interest, shall not exceed 1-1/4% of the taxable value of the real and personal property in the municipality as of the date of this Contract. If requested by Obligee, the finance officer of the Obligor will provide the statistical information to show that this obligation is within the 1-1/4% limitation.
- (n) The Equipment financed hereunder has a useful life in excess of the term of this Contract.
- (o) The Obligor hereby agrees to include in its budget for each year commencing with the current Budget Year, a sum which will be sufficient to pay the principal and interest due as set forth on Exhibit B of this Contract. In addition, the Obligor hereby pledges to levy ad valorem taxes on all taxable property in the Obligor each year in an amount necessary to make its debt service payments under this Contract, subject to applicable constitutional, statutory and charter tax rate limitations.
- (p) If Obligor defaults in its obligations under this Contract and Obligee receives judgment against Obligor, Obligor will be obligated to pay such judgment in full.

Section 2.02 Escrow Agreement. In the event both Obligee and Obligor mutually agree to utilize an Escrow Account, then immediately following the execution and delivery of this Contract, Obligee and Obligor agree to execute and deliver and to cause Escrow Agent to execute and deliver the Escrow Agreement. This Contract shall take effect only upon execution and delivery of the Escrow Agreement by the parties thereto. Obligee shall deposit or cause to be deposited with the Escrow Agent for credit to the Equipment Acquisition Fund the sum of N/A, which shall be held, invested and disbursed in accordance with the Escrow Agreement.

III. Acquisition of Equipment, Contract Payments and the Purchase Option Price

Section 3.01 Acquisition and Acceptance. Obligor shall be solely responsible for the ordering of the Equipment and for the delivery and installation of the Equipment. Execution of the Certificate of Acceptance or, alternatively, Payment Request and Equipment Acceptance Form, by a duly authorized representative of Obligor, shall constitute acceptance of the Equipment on behalf of the Obligor.

Section 3.02 Contract Payments. Obligor shall pay Contract Payments exclusively to Obligee or its assignees in lawful, legally available money of the United States of America. The Contract Payments shall be sent to the location specified by the Obligee or its assignees. The Contract Payments, payable without notice or demand, are due as set forth on Exhibit B. Obligee shall have the option to charge interest at the highest lawful rate on any Contract Payment received later than the due date for the number of days that the Contract Payment(s) were late, plus any additional accrual on the outstanding balance for the number of days that the Contract Payment(s) were late. Obligee shall also have the option, on monthly payments only, to charge a late fee of up to 10% of the monthly Contract Payment that is past due. Furthermore, Obligor agrees to pay any fees associated with the use of a payment system other than check, wire transfer, or ACH. Once all amounts due Obligee hereunder have been received, Obligee will release any and all of its rights, title and interest in the Equipment.

SECTION 3.03 CONTRACT PAYMENTS UNCONDITIONAL. THE OBLIGATIONS OF OBLIGOR TO MAKE CONTRACT PAYMENTS AND TO PERFORM AND OBSERVE THE OTHER COVENANTS CONTAINED IN THIS CONTRACT SHALL BE ABSOLUTE AND UNCONDITIONAL IN ALL EVENTS WITHOUT ABATEMENT, DIMINUTION, DEDUCTION, SET-OFF, OR SUBJECT TO DEFENSE OR COUNTERCLAIM.

Section 3.04 Purchase Option Price. Upon thirty (30) days written notice, Obligor shall have the option to pay, in addition to the Contract Payment, the corresponding Purchase Option Price which is listed on the same line on Exhibit B. This option is only available to the Obligor on the Contract Payment date and no partial prepayments are allowed. If Obligor chooses this option and pays the Purchase Option Price to Obligee then Obligee will transfer any and all of its rights, title and interest in the Equipment to Obligor.

Section 3.05 Contract Term. The Contract Term shall be the Original Term and all Renewal Terms until all the Contract Payments are paid as set forth on Exhibit B except as provided under Section 9.01 below.

Section 3.06 Disclaimer of Warranties. OBLIGEE MAKES NO WARRANTY OR REPRESENTATION, EITHER EXPRESS OR IMPLIED, AS TO THE VALUE, DESIGN, CONDITION, MERCHANTABILITY, FITNESS FOR PARTICULAR PURPOSE OR ANY OTHER WARRANTY WITH RESPECT TO THE EQUIPMENT. OBLIGEE IS NOT A MANUFACTURER, SELLER, VENDOR OR DISTRIBUTOR, OR AGENT THEREOF, OF SUCH EQUIPMENT; NOR IS OBLIGEE A MERCHANT OR IN THE BUSINESS OF DISTRIBUTING SUCH EQUIPMENT TO THE PUBLIC. OBLIGEE SHALL NOT BE LIABLE FOR ANY INCIDENTAL, INDIRECT, SPECIAL OR CONSEQUENTIAL DAMAGE ARISING OUT OF THE INSTALLATION, OPERATION, POSSESSION, STORAGE OR USE OF THE EQUIPMENT BY OBLIGOR.

Section 3.07 Contract with Vendor. Obligee hereby recognizes that Obligor has executed or will be executing a "Sales Contract" with the vendor for the actual sale of the Equipment. This Sales Contract provides, among other things, standard warranty protections to Obligor with regard to the Equipment. Obligee further recognizes and hereby acknowledges that nothing in this Contract shall impair the rights of the Obligor against the manufacturer for any warranty, or other obligations express or implied that the Obligor may have with the Equipment.

IV. Obligation

Section 4.01 Obligation. The Obligation of the Obligor to pay principal and interest under this Contract is a limited general obligation of the Obligor. The Obligor shall include in its budget and pay each year, until this Contract is paid in full, such sums as may be necessary each year to make all Contract Payments due hereunder. Furthermore, the Obligor covenants that it shall comply with all requirements of the Internal Revenue Code of 1986, as amended, that must be satisfied subsequent to delivery of this Contract in order that the interest thereon to be excluded from gross income for federal tax purposes.

V. Insurance, Damage, Insufficiency of Proceeds

Section 5.01 Insurance. Under Michigan Law and pursuant to the Resolution of the Obligor, the Obligor is fully responsible as the owner of the Equipment to make sure that it is insured for both property and liability. Obligor agrees to provide proof of such insurance to Obligee in the form satisfactory to Obligee. If the Obligor chooses to obtain insurance through a private insurer, the Obligor shall be solely responsible for selecting the insurer(s) and for making all premium payments. Obligor also hereby acknowledges that in the event of a casualty to the Equipment that the Obligor is still fully obligated to make all the scheduled Contract Payments to Obligee or to pay off the applicable Purchase Option Price to Obligee. If requested by Obligee, Obligor will list Obligee as loss payee and additional insured if any policies are obtained through a private insurer.

- (a) Obligor shall insure the Equipment against any loss or damage by fire and all other risks covered by the standard extended coverage endorsement then in use in the State and any other risks reasonably required by Obligee in an amount at least equal to the then applicable Purchase Option Price of the Equipment. Alternatively, Obligor may insure the Equipment under a blanket insurance policy or policies.
- (b) The liability insurance shall insure Obligee from liability and property damage in any form and amount satisfactory to Obligee.
- (c) Obligor may self-insure against the casualty risks and liability risks described above. If Obligor chooses this option, Obligor must furnish Obligee with a certificate and/or other documents which evidences such coverage.
- (d) All insurance policies issued or affected by this Section shall be so written or endorsed such that the Obligee and its assignees are named additional insureds and loss payees and that all losses are payable to Obligor and Obligee or its assignees as their interests may appear. Each policy issued or affected by this Section shall contain a provision that the insurance company shall not cancel or materially modify the policy without first giving thirty (30) days advance notice to Obligee or its assignees. Obligor shall furnish to Obligee certificates evidencing such coverage throughout the Contract Term.

Section 5.02 Damage to or Destruction of Equipment. Obligor assumes the risk of loss or damage to the Equipment. If the Equipment or any portion thereof is lost, stolen, damaged, or destroyed by fire or other casualty, Obligor will immediately report all such losses to all possible insurers and take the proper procedures to obtain all insurance proceeds. At the option of Obligee, Obligor shall either (1) apply the Net Proceeds to replace, repair or restore the Equipment or (2) apply the Net Proceeds to the applicable Purchase Option Price. For purposes of this Section and Section 5.03, the term Net Proceeds shall mean the amount of insurance proceeds collected from all applicable insurance policies after deducting all expenses incurred in the collection thereof.

Section 5.03 Insufficiency of Net Proceeds. If there are no Net Proceeds for whatever reason or if the Net Proceeds are insufficient to pay in full the cost of any replacement, repair, restoration, modification or improvement of the Equipment, then Obligor shall, at the option of Obligee, either (1) complete such replacement, repair, restoration, modification or improvement and pay any costs thereof in excess of the amount of the Net Proceeds or (2) apply the Net Proceeds to the Purchase Option Price and pay the deficiency, if any, to the Obligee.

Section 5.04 Obligor Negligence. Obligor assumes all risks and liabilities, whether or not covered by insurance, for loss or damage to the Equipment and for injury to or death of any person or damage to any property whether such injury or death be with respect to agents or employees of Obligor or of third parties, and whether such property damage be to Obligor's property or the property of others (including, without limitation, liabilities for loss or damage related to the release or threatened release of hazardous substances under the Comprehensive Environmental Response, Compensation and Liability Act, the Resource Conservation and Recovery Act or similar or successor law or any State or local equivalent now existing or hereinafter enacted which in any manner arise out of or are incident to any possession, use, operation, condition or storage of any Equipment by Obligor), which is proximately caused by the negligent conduct of Obligor, its officers, employees and agents.

Section 5.05 Reimbursement. Obligor hereby assumes responsibility for and agrees to reimburse Obligee for all liabilities, obligations, losses, damages, penalties, claims, actions, costs and expenses (including reasonable attorneys' fees) of whatsoever kind and nature, imposed on, incurred by or asserted against Obligee that in any way relate to or arise out of a claim, suit or proceeding, based in whole or in part upon the negligent conduct of Obligor, its officers, employees and agents, or arose out of installation, operation, possession, storage or use of any item of the Equipment, to the maximum extent permitted by law.

VI. Title and Security Interest

Section 6.01 Title. Title to the Equipment shall vest in Obligor when Obligor acquires and accepts the Equipment. Title to the Equipment will automatically transfer to the Obligee in the event Obligor defaults under Section 9.01. In such event, Obligor shall execute and deliver to Obligee such documents as Obligee may request to evidence the passage of legal title to the Equipment to Obligee.

Section 6.02 Security Interest. To secure the payment of all Obligor's obligations under this Contract, as well as all other obligations, debts and liabilities, plus interest thereon, whether now existing or subsequently created, Obligor hereby grants to Obligee a security interest under the Uniform Commercial Code constituting a first lien on the Equipment described more fully on Exhibit A. Furthermore, Obligor agrees that any other collateral securing any other obligation(s) to Obligee, whether offered prior to or subsequent hereto, also secures this obligation. The security interest established by this section includes not only all additions, attachments, repairs and replacements to the Equipment but also all proceeds therefrom. Obligor authorizes Obligee to prepare and record any Financing Statement required under the Uniform Commercial Code to perfect the security interest created hereunder. Obligor agrees that any Equipment listed on Exhibit A is and will remain personal property and will not be considered a fixture even if attached to real property.

VII. Assignment

Section 7.01. Assignment by Obligees. All of Obligees' rights, title and/or interest in and to this Contract may be assigned and reassigned in whole or in part to one or more assignees or sub-assignees by Obligees at any time without the consent of Obligor. No such assignment shall be effective as against Obligor until the assignor shall have filed with Obligor written notice of assignment identifying the assignee. Obligor shall pay all Contract Payments due hereunder relating to such Equipment to or at the direction of Obligees or the assignee named in the notice of assignment. Obligor shall keep a complete and accurate record of all such assignments.

Section 7.02. Assignment by Obligor. None of Obligor's right, title and interest under this Contract and in the Equipment may be assigned by Obligor unless Obligees approves of such assignment in writing before such assignment occurs and only after Obligor first obtains an opinion from nationally recognized counsel stating that such assignment will not jeopardize the tax-exempt status of the obligation.

VIII. Maintenance of Equipment

Section 8.01. Equipment. Obligor shall keep the Equipment in good repair and working order, and as required by manufacturer's and warranty specifications. If Equipment consists of copiers, Obligor is required to enter into a copier maintenance/service agreement. Obligees shall have no obligation to inspect, test, service, maintain, repair or make improvements or additions to the Equipment under any circumstances. Obligor will be liable for all damage to the Equipment, other than normal wear and tear, caused by Obligor, its employees or its agents. Obligor shall pay for and obtain all permits, licenses and taxes related to the ownership, installation, operation, possession, storage or use of the Equipment. If the Equipment includes any titled vehicle(s), then Obligor is responsible for obtaining such title(s) from the State and also for ensuring that Obligees is listed as First Lienholder on all of the title(s). Obligor shall not use the Equipment to haul, convey or transport hazardous waste as defined in the Resource Conservation and Recovery Act, 42 U.S.C. 6901 et. seq. Obligor agrees that Obligees or its Assignee may execute any additional documents including financing statements, affidavits, notices, and similar instruments, for and on behalf of Obligor which Obligees deems necessary or appropriate to protect Obligees' interest in the Equipment and in this Contract. Obligor shall allow Obligees to examine and inspect the Equipment at all reasonable times.

IX. Default

Section 9.01. Events of Default defined. The following events shall constitute an "Event of Default" under this Contract:

- (a) Failure by Obligor to pay any Contract Payment listed on Exhibit B for fifteen (15) days after such payment is due according to the Payment Date listed on Exhibit B.
- (b) Failure to pay any other payment required to be paid under this Contract at the time specified herein and a continuation of said failure for a period of fifteen (15) days after written notice by Obligees that such payment must be made. If Obligor continues to fail to pay any payment after such period, then Obligees may, but will not be obligated to, make such payments and charge Obligor for all costs incurred plus interest at the highest lawful rate.
- (c) Failure by Obligor to observe and perform any warranty, covenant, condition, promise or duty under this Contract for a period of thirty (30) days after written notice specifying such failure is given to Obligor by Obligees, unless Obligees agrees in writing to an extension of time. Obligees will not unreasonably withhold its consent to an extension of time if corrective action is instituted by Obligor. Subsection (c) does not apply to Contract Payments and other payments discussed above.
- (d) Any statement, material omission, representation or warranty made by Obligor in or pursuant to this Contract which proves to be false, incorrect or misleading on the date when made regardless of Obligor's intent and which materially adversely affects the rights or security of Obligees under this Contract.
- (e) Any provision of this Contract which ceases to be valid for whatever reason and the loss of such provision would materially adversely affect the rights or security of Obligees.
- (f) Obligor admits in writing its inability to pay its obligations.
- (g) Obligor defaults on one or more of its other obligations.
- (h) Obligor becomes insolvent, is unable to pay its debts as they become due, makes an assignment for the benefit of creditors, applies for or consents to the appointment of a receiver, trustee, conservator, custodian, or liquidator of Obligor, or all or substantially all of its assets, or a petition for relief is filed by Obligor under federal bankruptcy, insolvency or similar laws, or is filed against Obligor and is not dismissed within thirty (30) days thereafter.

Section 9.02. Remedies on Default. Whenever any Event of Default exists, Obligees shall have the right to take one or any combination of the following remedial steps:

- (a) If Obligor fails to make scheduled Contract Payments, then Obligees shall have the right to obtain a judgment against Obligor in an amount not less than the sum of all Contract Payments due as set forth on Exhibit B plus any other amounts that may be owing hereunder. Obligor will be liable for any damage to the Equipment caused by Obligor or its employees or agents. Obligor shall be responsible to Obligees for all costs incurred by Obligees in the enforcement of its rights under this Contract including, but not limited to, reasonable attorney fees.
- (b) With or without terminating this Contract, Obligees may require Obligor at Obligor's expense to redeliver any or all of the Equipment and any additional collateral to Obligees to a location specified by Obligees. If Obligees exercises this remedy, Obligees will provide Obligor written notice at least fifteen (15) days prior to the date the Equipment is to be delivered to Obligees. If Obligor fails to deliver the Equipment and any additional collateral, Obligees may enter the premises where the Equipment and any additional collateral is located and take possession of the Equipment and any additional collateral and charge Obligor for costs incurred. Notwithstanding that Obligees has taken possession of the Equipment and any additional collateral, Obligor shall still be obligated to pay the remaining Contract Payments due up until the end of the Contract Term. Obligor will be liable for any damage to the Equipment and any additional collateral caused by Obligor or its employees or agents.

Section 9.03. No Remedy Exclusive. No remedy herein conferred upon or reserved to Obligees is intended to be exclusive and every such remedy shall be cumulative and shall be in addition to every other remedy given under this Contract now or hereafter existing at law or in equity. No delay or omission to exercise any right or power accruing upon any default shall impair any such right or shall be construed to be a waiver thereof.

Section 9.04. Return of Equipment and Storage.

- (a) **Surrender:** The Obligor shall, at its own expense, surrender the Equipment, any additional collateral and all required documentation to evidence transfer of title from Obligor to the Obligees in the event of a default by delivering the Equipment and any additional collateral to the Obligees to a location accessible by common carrier and designated by Obligees. In the case that any of the Equipment and any additional collateral consists of software, Obligor shall destroy all intangible items constituting such software and shall deliver to Obligees all tangible items constituting such software. At Obligees' request, Obligor shall also certify in a form acceptable to Obligees that Obligor has complied with the above software return provisions and that they will immediately cease using the software and that they shall permit Obligees and/or the vendor of the software to inspect Obligor's locations to verify compliance with the terms hereto.
- (b) **Delivery:** The Equipment and any additional collateral shall be delivered to the location designated by the Obligees by a common carrier unless the Obligees agrees in writing that a common carrier is not needed. When the Equipment and any additional collateral is delivered into the custody of a common carrier, the Obligor shall arrange for the shipping of the item and its insurance in transit in accordance with the Obligees' instructions and at the Obligor's sole expense. Obligor at its expense shall completely sever and disconnect the Equipment and any additional collateral or its component parts from the Obligor's property all without liability to the Obligees. Obligor shall pack or crate the Equipment and any additional collateral and all of the component parts of the Equipment and any additional collateral carefully and in accordance with any recommendations of the manufacturer. The Obligor shall deliver to the Obligees the plans, specifications, operation manuals or other warranties and documents furnished by the manufacturer or vendor on the Equipment and any additional collateral and such other documents in the Obligor's possession relating to the maintenance and methods of operation of such Equipment and any additional collateral.
- (c) **Condition:** When the Equipment is surrendered to the Obligees it shall be in the condition and repair required to be maintained under this Contract. It will also meet all legal regulatory conditions necessary for the Obligees to sell or lease it to a third party and be free of all liens. If Obligees reasonably determines that the Equipment or an item of the Equipment, once it is returned, is not in the condition required hereby, Obligees may cause the repair, service, upgrade, modification or overhaul of the Equipment or an item of the Equipment to achieve such condition and upon demand, Obligor shall promptly reimburse Obligees for all amounts reasonably expended in connection with the foregoing.
- (d) **Storage:** Upon written request by the Obligees, the Obligor shall provide free storage for the Equipment and any additional collateral for a period not to exceed 60 days after the expiration of the Contract Term before returning it to the Obligees. The Obligor shall arrange for the insurance described to continue in full force and effect with respect to such item during its storage period and the Obligees shall reimburse the Obligor on demand for the incremental premium cost of providing such insurance.

X. Miscellaneous

Section 10.01 Notices. All notices shall be sufficiently given and shall be deemed given when delivered or mailed by registered mail, postage prepaid, to the parties at their respective places of business as first set forth herein or as the parties shall designate hereafter in writing.

Section 10.02 Binding Effect. Obligor acknowledges this Contract is not binding upon the Obligee or its assignees unless the Conditions to Funding listed on the Documentation Instructions have been met to Obligee's satisfaction, and Obligee has executed the Contract. Thereafter, this Contract shall inure to the benefit of and shall be binding upon Obligee and Obligor and their respective successors and assigns.

Section 10.03 Severability. In the event any provision of this Contract shall be held invalid or unenforceable by any court of competent jurisdiction, such holding shall not invalidate or render unenforceable any other provision hereof.

Section 10.04 Amendments, Addenda, Changes or Modifications. This Contract may be amended, added to, changed or modified by written agreement duly executed by Obligee and Obligor. Furthermore, Obligee reserves the right to directly charge or amortize into the remaining balance due from Obligor, a reasonable fee, to be determined at that time, as compensation to Obligee for the additional administrative expense resulting from such amendment, addenda, change or modification requested by Obligor.

Section 10.05 Execution in Counterparts. This Contract may be simultaneously executed in several counterparts, each of which shall be an original and all of which shall constitute but one and the same instrument.

Section 10.06 Captions. The captions or headings in this Contract do not define, limit or describe the scope or intent of any provisions or sections of this Contract.

Section 10.07 Master Contract. This Contract can be utilized as a Master Contract. This means that the Obligee and the Obligor may agree to the financing of additional Equipment under this Contract at some point in the future by executing one or more Additional Schedules to Exhibit A and Exhibit B, as well as other exhibits or documents that may be required by Obligee. Additional Schedules will be consecutively numbered on each of the exhibits which make up the Additional Schedule and all the terms and conditions of the Contract shall govern each Additional Schedule.

Section 10.08 Entire Writing. This Contract constitutes the entire writing between Obligee and Obligor. No waiver, consent, modification or change of terms of this Contract shall bind either party unless in writing and signed by both parties, and then such waiver, consent, modification or change shall be effective only in the specific instance and for the specific purpose given. There are no understandings, agreements, representations, conditions, or warranties, express or implied, which are not specified herein regarding this Contract, the Equipment or any additional collateral, financed hereunder. Any terms and conditions of any purchase order or other documents submitted by Obligor in connection with this Contract which are in addition to or inconsistent with the terms and conditions of this Contract will not be binding on Obligee and will not apply to this Contract.

Obligee and Obligor have caused this Contract to be executed in their names by their duly authorized representatives listed below.

City of Flint, Michigan

Lease Servicing Center, Inc. dba National Cooperative Leasing



Signature
Clyde D. EDWARDS

Printed Name and Title

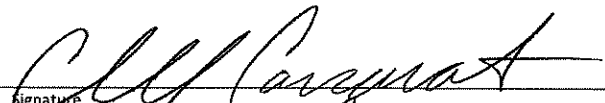

Signature
CHRISTOPHER J. CONROY

Printed Name and Title
Sec/Treas

EXHIBIT A
DESCRIPTION OF EQUIPMENT

RE: Government Obligation Contract dated as of December 27, 2019, between Lease Servicing Center, Inc. dba National Cooperative Leasing (Obligee) and City of Flint, Michigan (Obligor)

Below is a detailed description of all the items of Equipment including quantity, model number and serial number where applicable:

Seven (7) 2020 International HV607 Plow Trucks

Physical Address of Equipment after Delivery :

702 W. 12th Street, Flint, MI 48503

EXHIBIT B

PAYMENT SCHEDULE

RE: Government Obligation Contract dated as of December 27, 2019, between Lease Servicing Center, Inc. dba National Cooperative Leasing (Obligee) and City of Flint, Michigan (Obligor)

Date of First Payment: At Closing
 Original Balance: \$1,491,805.00
 Total Number of Payments: Six (6)
 Number of Payments Per Year: One (1)

Pmt No.	Due Date	Contract Payment	Applied to Interest	Applied to Principal	*Purchase Option Price
1	At Closing	\$272,943.78	\$0.00	\$272,943.78	\$1,269,664.26
2	27-Sep-20	\$272,943.78	\$39,415.58	\$233,528.20	\$1,022,616.34
3	27-Sep-21	\$272,943.78	\$41,712.52	\$231,231.26	\$776,976.42
4	27-Sep-22	\$272,943.78	\$31,923.71	\$241,020.07	\$524,777.91
5	27-Sep-23	\$272,943.78	\$21,720.51	\$251,223.27	\$265,845.70
6	27-Sep-24	\$272,943.78	\$11,085.36	\$261,858.42	\$0.00

City of Flint, Michigan

 Signature
 Clyde D. Edwards, City Administrator
 Printed Name and Title

*Assumes all Contract Payments due to date are paid

EXHIBIT C

CERTIFICATE OF ACCEPTANCE

RE: Government Obligation Contract dated as of December 27, 2019, between Lease Servicing Center, Inc. dba National Cooperative Leasing (Obligee) and City of Flint, Michigan (Obligor)

I, the undersigned, hereby certify that I am a duly qualified representative of Obligor and that I have been given the authority by the Governing Body of Obligor to sign this Certificate of Acceptance with respect to the above referenced Contract. I hereby certify that:

1. The Equipment described on Exhibit A has been delivered and installed in accordance with Obligor's specifications.
2. Obligor has conducted such inspection and/or testing of the Equipment as it deems necessary and appropriate and hereby acknowledges that it accepts the Equipment for all purposes.
3. Obligor has appropriated and/or taken other lawful actions necessary to provide moneys sufficient to pay all Contract Payments required to be paid under the Contract during the current Budget Year of Obligor, and such moneys will be applied in payment of all Contract Payments due and payable during such current Budget Year.
4. Obligor has obtained insurance coverage as required under the Contract from an insurer qualified to do business in the State.
5. No event or condition that constitutes or would constitute an Event of Default exists as of the date hereof.
6. The governing body of Obligor has approved the authorization, execution and delivery of this Contract on its behalf by the authorized representative of Obligor who signed the Contract.
7. Please list the Source of Funds (Fund Item in Budget) for the Contract Payments that come due under Exhibit B of this Contract.

Source of Funds : Fleet Fund

By signing below, Obligor hereby authorizes the General Fund of the Obligor as a backup source of funds from which the Contract Payments can be made.

City of Flint, Michigan

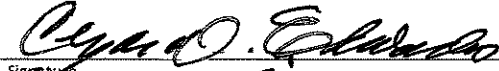

Signature

Cynthia D. Edwards, City Administrator

Printed Name and Title

190417

(CONTRACT)

SUBMISSION NO. _____

PRESENTED: 10-9-19

ADOPTED: 10-14-2019

RESOLUTION TO NATIONAL COOPERATIVE LEASING FOR SEVEN (7) TANDEM AXLE DUMP TRUCKS

BY THE CITY ADMINISTRATOR:

RESOLUTION

As part of the replacement plan for FY20, the Fleet Department is requesting the issuance of a purchase order to lease/purchase seven (7) each 2019 Tandem Axle Dump Trucks with underbody, wing and front snow plows from the MIDEal vendor, Tri County International Trucks (Contract #071B6600122) with financing through National Cooperative Leasing using Sourcewell Contract#032615-NCL ; and

National Cooperative Leasing, 220 22nd Ave. E. Suite 106, Alexandria, MN has submitted a municipal cost agreement to lease/purchase said vehicles using NCL's Source well Contract #032615-NCL. The trucks are to be utilized by the Street Maintenance Department for construction operations and snow removal. The trucks will replace seven (7) 2006 Peterbilt Dump Trucks that have been in service for fourteen (14) years. The Municipal lease term is for six (6) years with an annual payment of \$278,186.65 per year, with a \$1 per vehicle buyout at the end of the lease. Funding for said services will come from the following account: 661-451 100-940.000.

IT IS RESOLVED, that the Proper City Officials are hereby authorized to approve the issuance of a purchase order for the first year of a six years lease/purchase of seven (7) each Tandem Axle Dump Trucks with underbody, wing and front snow plows with financing through National Cooperative Leasing over a six year lease/per year, in an amount not to exceed annually of \$278,186.6 with a \$1 per vehicle buyout at the end of the lease

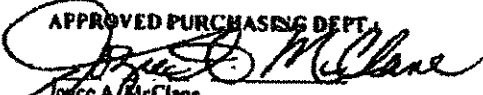
APPROVED PURCHASING DEPT.

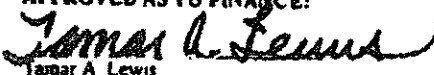
Joyce A. McClane
Purchasing Manager

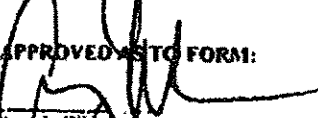
APPROVED AS TO FINANCE:

Tamar A. Lewis
Deputy Finance Director

APPROVED AS TO FORM:

Angela Wheeler
Chief Legal Officer

Steve Branch, City Administrator

Herbert J. Winfrey, Council President

Resolution resolving that 8th Ward Flint City Councilperson Allan Griggs hereby appoints Zack Lessner (1813 Lincoln Drive, Flint, MI 48503) to the Ethics and Accountability Board to serve the remainder of a four (4)-year term, commencing November 25, 2019, and expiring June 25, 2022. [By way of background, Mr. Lessner is replacing John Daly III, who resigned from the Board effective November 12, 2019.]

APPOINTMENTS (May Be Referred from Special Affairs)

190478 Mayoral Appointment/City Administrator/Clyde D. Edwards

Resolution resolving that the Flint City Council approves the recommendation by Mayor Sheldon A. Neeley to appoint Clyde D. Edwards as City Administrator, at an annual compensation rate of \$90,000.00, with such earnings paid from Salary and Wages Acct. No. 101-172.100-702.000.

190481 Appointment/Ethics and Accountability Board/Joseph Pettigrew

Resolution resolving that 9th Ward Flint City Councilperson Eva L. Worthing hereby appoints Joseph Pettigrew (3214 Cheyenne Avenue, Flint, Michigan, 48507) to the Ethics and Accountability Board for the remainder of a six-year term of office, commencing November 25, 2019, and expiring June 25, 2024. [NOTE: By way of background, Bob Gallagher resigned from his position on the EAB Board effective October 30, 2019.]

RESOLUTIONS

190394 Sale of Properties/Acquired from the Genesee County Treasurer

Resolution resolving that the Flint City Council authorizes the appropriate City Officials to do all things necessary to facilitate the sale of the following properties in the following amounts: 6722 Fleming Road, Flint, for \$1,000.00. [NOTE: The Flint City Council adopted a policy, Resolution No. 180627, on April 8, 2019, entitled "City of Flint Policy of Disposition of Acquired Genesee County Treasurer Properties," to handle the sale of such properties.]

190477 CO#1/Wade Trim, Inc./Construction Engineering Services/Atherton Road/Dupont Street

Resolution authorizing the Department of Purchases and Supplies to issue change order #1 to Wade Trim, Inc. for Construction Engineering Services for Atherton Road and Dupont Street, to change the account from the Tiger Grant (296-446.300-810.000), to the Major Street Fund Acct. No. 202-441.702-801.000, as requested by Transportation. [NOTE: The Department of Purchases & Supplies was authorized to issue a purchase order to Wade Trim, Inc. for construction engineering services for Atherton Road and Dupont Street in an amount NOT-TO-EXCEED \$3,304,735.00. The remaining money (\$1,180,000.00) is still allocated from the Water Infrastructure Improvements for the Nation (WIIN) and Major Street funds.]

190478

RESOLUTION NO _____

PRESENTED: _____

ADOPTED: _____

RESOLUTION APPROVING THE APPOINTMENT OF CLYDE D. EDWARDS AS THE CITY ADMINISTRATOR

BY THE MAYOR:

Pursuant to Flint City Charter Section 4-201, the Mayor of the City of Flint hereby appoints Clyde D. Edwards as the City Administrator.

WHEREAS, the City Administrator shall be paid a salary based on an annual compensation rate of \$90,000.00 and paid from account number 101-172.100-702.000. The terms of appointment are attached.

WHEREAS, Mayor Sheldon A. Neeley recommends that Clyde D. Edwards be appointed as the City Administrator.

NOW THEREFORE BE IT RESOLVED, that the Flint City Council approves the recommendation by Mayor Sheldon A. Neeley to appoint Clyde D. Edwards as the City Administrator.

APPROVED AS TO FORM:



Angela Wheeler, Chief Legal Officer

APPROVED AS TO FINANCE:



Tamar Lewis, Deputy Financial Officer

FOR THE CITY OF FLINT:



Sheldon A. Neeley, Mayor

APPROVED BY CITY COUNCIL:

Monica Galloway, City Council President

EXHIBIT E

ACT 99 CERTIFICATE

RE: Government Obligation Contract dated as of December 27, 2019, between Lease Servicing Center, Inc. dba National Cooperative Leasing (Obligee) and City of Flint, Michigan (Obligor)

The undersigned, the duly authorized and qualified Finance Director of City of Flint, Michigan, County of Genesee, State of Michigan (the "Obligor"), in connection with the execution by the Obligor of the Government Obligation Contract (the "Contract"), in the amount of \$1,491,805.00, dated as of December 27, 2019 by and between the Obligor and Lease Servicing Center, Inc. dba National Cooperative Leasing, hereby certifies as follows:

1. The outstanding balance of all purchases authorized under Act 99 of 1933, exclusive of interest, do not exceed 1-1/4% of the taxable value of the real and personal property in the municipality as of the date of this Contract.
2. Upon request, Obligor can provide to Obligee specific dollar amounts to support this certification.

City of Flint, Michigan



Signature of Finance Director

Amanda Trojillo, Acting Chief Financial Officer

Printed Name and Title

12/19/19

Dated



CITY OF FLINT, MICHIGAN
Department of Law

Angela Wheeler
Chief Legal Officer

Sheldon A. Neeley
Mayor

OPINION OF COUNSEL

December 16, 2019

Lease Servicing Center, Inc. dba National Cooperative Leasing
220 22nd Avenue East, Suite 106
Alexandria, Minnesota 56308

RE: Government Obligation Contract dated as of December 16, 2019 between Lease Servicing Center, Inc. dba National Cooperative Leasing (Obligee) and City of Flint, Michigan (Obligor)

Ladies and Gentlemen:

As legal counsel to Obligor, I have examined the foregoing Contract and such other opinions, documents and matters of law as I have deemed necessary in connection with the Contract. Based on the foregoing, I am of the following opinions:

1. Obligor is a political subdivision of the State of Michigan, or a constituted authority authorized to issue obligations on behalf of a political subdivision of the State.
2. Obligor has the requisite power and authority to purchase the Equipment and to execute and deliver the Contract and to perform its obligations under the Contract. The Contract and the other documents either attached hereto or required herein have been duly authorized, approved and executed by and on behalf of Obligor, and the Contract is a legal, valid and binding obligation of Obligor enforceable in accordance with its terms.
3. The authorization, approval and execution of the Contract and all other proceedings of Obligor relating to the transactions contemplated thereby have been performed in accordance with all open meeting laws, public bidding laws and all other applicable state and federal laws.
4. There is no litigation, action, suit or proceeding pending or before any court, administrative agency, arbitrator or governmental body that challenges the authority of the Obligor of any of the Obligor's officers or employees to enter into the Contracts.
5. The above opinion is for the sole benefit of the Obligee listed above and can only be relied upon by the Obligee or any permitted assignee or subassignee or successor of Obligee under the Contract.

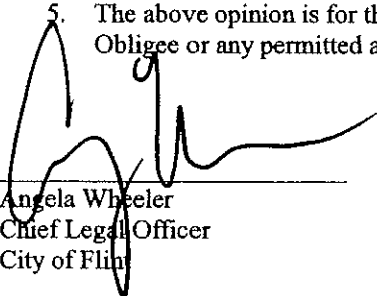

Angela Wheeler
Chief Legal Officer
City of Flint

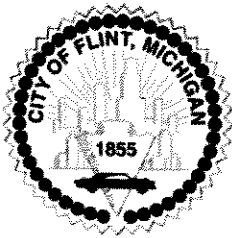

RESOLUTION NO.: 240287

PRESENTED: 7-17-2024

ADOPTED: _____

PROPOSAL #21000605

BY THE CITY ADMINISTRATOR:

**RESOLUTION TO DHT TRANSPORT, LLC FOR SEWAGE SLUDGE TRANSPORTATION SERVICES:
CHANGE ORDER #1 FOR FY2024**

WHEREAS, The Division of Purchases and supplies solicited proposals for Sewage Sludge Transportation services on behalf of the Water Pollution Control Facility. The Water Pollution Control Facility generates approximately 12,000 wet tons of biosolids cake and grit (“Residuals”) from its wastewater treatment process annually. Residuals must be transported off-plant site to a landfill or other disposal site every weekday. The services are to be provided with fixed rates, for a period of (3) fiscal years. The contract is in effect for FY22, FY23 and FY24.

WHEREAS, Flint City Council adopted Resolution #220288 on July 25, 2022, authorizing a contract with DHT Transportation for FY23 and FY24 in an amount not to exceed \$250,000 for each year.

WHEREAS, Due to rainy weather conditions, the WPC generated more biosolids than anticipated and therefore is requested a change order for FY24 for excessive hauling and transportation of sludge cake biosolids for an additional \$40,000.00.

Funding is to come from the following account(s):

Account Number	Account Name/ Grant Code	Amount
590-550.300-801.000	PROFESSIONAL SERVICES	\$40,000.00
	FY2024 (GRAND) TOTAL	\$290,000.00

IT IS RESOLVED, that the Proper City Officials are hereby authorized to enter into a change order with DHT Transportation for additional sludge hauling and transportation services not to exceed \$40,000.00 for FY2024 (07/01/23-06/30/24) for an FY24 Grand Total amount not to exceed \$290,000.00.

APPROVED AS TO FORM:

William Kim (Jul 3, 2024 07:43 EDT)

William Kim, City Attorney

APPROVED AS TO FINANCE:

Phillip Moore (Jul 3, 2024 07:39 EDT)

Phillip Moore, Chief Financial Officer

FOR THE CITY OF FLINT:

CLYDE D EDWARDS / A0238
CLYDE D EDWARDS / A0238 (Jul 3, 2024 10:56 EDT)

Clyde Edwards, City Administrator

APPROVED BY CITY COUNCIL:

City Council

APPROVED AS TO PURCHASING:



Lauren Rowley, Purchasing Manager

Lauren Rowley, Purchasing Manager

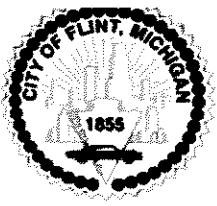

CITY OF FLINT STAFF REVIEW FORM

TODAY'S DATE: 6/24/2024

BID/PROPOSAL# Proposal 21000605

AGENDA ITEM TITLE: Sewage Sludge Cake Hauling/Transport Services, Approved 07/20/2022-Resolution 220288

PREPARED BY: Jeanette Best, DPW - Water Pollution Control

VENDOR NAME: DHT Transportation

BACKGROUND/SUMMARY OF PROPOSED ACTION:

Water Pollution Control (WPC) generates approximately 13,000 wet tons of sludge (biosolids) cake and grit ("residuals") from its wastewater treatment process annually. Residuals must be transported to a landfill or other disposal site every weekday. These services are provided with fixed rates, for a period of three fiscal years. The Contract is in effect for FY2022, FY2023, and FY2024. DHT Transportation was awarded the Contract for sludge cake hauling/transportation services as the lowest cost qualified bidder in the amount of \$250,000 per year for three fiscal years totaling \$750,000.

This year FY2024 the WPC generated more (sludge cake) biosolids than anticipated, due to wet weather, that needs to be transported to the landfill. The FY 2024 cost for the excessive hauling/transportation will be an additional \$40,000.00

PREVIOUS ALLOCATIONS (INCLUDE ALL ACCOUNTS USED FOR THIS PURPOSE)/ PROVIDE RESOLUTION OR CONTRACT INFORMATION THAT APPLIES

Sewage Sludge Cake Hauling/Transportation Services, Approved 07/20/2022-Resolution 220288
Account: Sludge Disposal Services, 590-550.100-815.550.

POSSIBLE BENEFIT TO THE CITY OF FLINT (RESIDENTS AND/OR CITY OPERATIONS) INCLUDE PARTNERSHIPS AND COLLABORATIONS:



CITY OF FLINT STAFF REVIEW FORM

FINANCIAL IMPLICATIONS:

\$250,000.00 from previous fiscal year allocations plus \$40,000.00 from this request. Total for FY 2024 \$290,000.00.

BUDGETED EXPENDITURE? YES NO IF NO, PLEASE EXPLAIN:

Dept.	Name of Account	Account Number	Grant Code	Amount
DPW-WPC	Professional Services	590-550.300-801.000		\$40,000.00
		Previous FY 2024 Purchase Orders		\$250,000.00
FY2024 GRAND TOTAL				\$290,000.00

PRE-ENCUMBERED? YES NO REQUISITION NO: 240008920

ACCOUNTING APPROVAL: *[Signature]* Date: 06/24/2024

WILL YOUR DEPARTMENT NEED A CONTRACT? YES NO

WHEN APPLICABLE, IF MORE THAN ONE (1) YEAR, PLEASE ESTIMATE TOTAL AMOUNT FOR EACH BUDGET YEAR: *(This will depend on the term of the bid proposal)*

BUDGET YEAR 1 \$

BUDGET YEAR 2

BUDGET YEAR 3

OTHER IMPLICATIONS *(i.e., collective bargaining)*:

STAFF RECOMMENDATION: *(PLEASE SELECT)*: APPROVED NOT APPROVED

DEPARTMENT HEAD SIGNATURE: *[Signature]*
(Jeanette M. Best, WPC/DPW Manager)

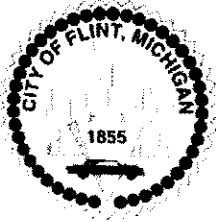

RESOLUTION NO.: 220288

PRESENTED: JUL 20 2022

ADOPTED: JUL 25 2022

PROPOSAL# 21000605

BY THE CITY ADMINISTRATOR:

RESOLUTION TO DHT TRANSPORT, LLC FOR SEWAGE SLUDGE TRANSPORTATION SERVICES

WHEREAS, Water Pollution Control generates approximately 12,000 wet tons of biosolids cake and grit ("Residuals") from its wastewater treatment process annually. Residuals must be transported off plant site to a landfill or other disposal site every weekday. The services are to be provided with fixed rates, for a period of three fiscal years. The contracts will be in effect for FY2022, FY2023, and FY2024. Three bids were reviewed and a split award is recommended.

WHEREAS, WPC recommends the lowest qualified bidder, DHT Transport, LLC, Reese, MI be awarded the bid for transportation services in the amount of \$250,000 for FY2022 (approved by City Council on June 14, 2021 via Resolution #210264) \$250,000 for FY2023, and \$250,000 for FY2024, totaling \$750,000.

Account Number	Account Name	Amount
590-550.100-815.550	Sludge Disposal Services	FY23 Total \$250,000.00
		FY24 Total \$250,000.00
	FY23/FY24 GRAND TOTAL	\$500,000.00

IT IS RESOLVED, that appropriate City Officials, are hereby authorized to enter into year two (2) of the contract with DHT Transportation to provide sludge disposal transportation services for FY23 (07/01/22-06/30/23) in an amount not-to-exceed \$250,000.00, and year three (3) of the contract for FY24 (07/01/23-06/30/24), pending budget adoption, in an amount not-to-exceed \$250,000.00.

APPROVED AS TO FORM:

William Kim
William Kim (Jul 12, 2022 10:46 EDT)

William Kim, City Attorney

APPROVED AS TO FINANCE:

Robert J.F. Widigan
Robert J.F. Widigan (Jul 12, 2022 16:31 EDT)

Robert J.F. Widigan, Chief Financial Officer

FOR THE CITY OF FLINT:

Clyde D. Edwards
Clyde D. Edwards (Jul 12, 2022 17:38 EDT)

Clyde Edwards, City Administrator

APPROVED BY CITY COUNCIL:

APPROVED BY
CITY COUNCIL
[Signature]
JUL 25 2022

APPROVED AS TO PURCHASING:

Lauren Rowley

Lauren Rowley, Purchasing Manager



CITY OF FLINT

STAFF REVIEW FORM

TODAY'S DATE: 07/05/2022

BID/PROPOSAL: Proposal 21000605

AGENDA ITEM TITLE: Sewage Sludge Cake Hauling/Transport Services

PREPARED BY: Krystal Wallace, Water Pollution Control

VENDOR NAME: DHT Transportation

BACKGROUND/SUMMARY OF PROPOSED ACTION:

Water Pollution Control (WPC) generates approximately 13,000 wet tons of biosolids cake and grit ("residuals") from its wastewater treatment process annually. Residuals must be transported off plant site to a landfill or other disposal site every weekday. The services are to be provided with fixed rates, for a period of three fiscal years. The Contracts will be in effect for FY2022, FY2023, and FY2024. Three Bids were reviewed and a split award is recommended.

WPC recommends the lowest qualified bidder; DHT Transportation be awarded the bid for sludge cake hauling/transportation services in the amount of \$250,000.00 for each of the next three fiscal years, FY 2022, 2023, & 2024, a three-(3) year total of \$750,000.00.

FINANCIAL IMPLICATIONS: None

BUDGETED EXPENDITURE? YES NO IF NO, PLEASE EXPLAIN:

Dept.	Name of Account	Account Number	Grant Code	Amount
DPW-WPC	Sludge Disposal Services	590-550.100-815.550		\$250,000.00
FY2023 GRAND TOTAL				\$250,000.00

PRE-ENCUMBERED? YES NO REQUISITION NO: 230005691

ACCOUNTING APPROVAL: *Krystal Wallace* Date: *07/05/2022*

WILL YOUR DEPARTMENT NEED A CONTRACT? YES NO
(If yes, please indicate how many years for the contract) 3 YEARS, \$250,000.00 per year

OTHER IMPLICATIONS (i.e., collective bargaining): None.

STAFF RECOMMENDATION: (PLEASE SELECT): APPROVED NOT APPROVED

AUTHORIZED SIGNATURE: *Jeanette Best*
(Jeanette Best, WPC Manager)



PROPOSAL# 21000605

RESOLUTION NO.: 210264
PRESENTED: JUN - 9 2021
ADOPTED: JUN 14 2021

BY THE CITY ADMINISTRATOR:

RESOLUTION TO DHT TRANSPORTATION FOR SEWAGE SLUDGE TRANSPORT SERVICES

WHEREAS, Water Pollution Control (WPC) generates approximately 13,000 wet tons of biosolids cake and grit ("residuals") from its wastewater treatment process annually. Residuals must be transported off plant site to a landfill or other disposal site every weekday. The services are to be provided with fixed rates, for a period of three fiscal years. The contracts will be in effect for FY2022, FY2023, and FY2024. Three bids were reviewed and a split award is recommended.

WPC recommends the lowest qualified bidder, DHT Transportation be awarded the bid for transportation services in the amount of \$250,000 for each of the next three fiscal years FY2022, FY2023, and FY2024, totaling \$750,000.

Account Number	Account Name	Amount
590-550.100-801.500	Sludge Disposal Services	\$250,000.00
	FY2022 GRAND TOTAL	\$250,000.00

IT IS RESOLVED, that the appropriate City Officials are authorized to do all things necessary to enter into a contract with DHT Transportation to provide sludge disposal transportation services for FY2022, pending budget adoption, for the amount of \$250,000.00.

APPROVED AS TO FORM:

Angela Wheeler
Angela Wheeler, Chief Legal Officer

APPROVED AS TO FINANCE:

Shelbi Frayer
Shelbi Frayer, Chief Financial Officer

FOR THE CITY OF FLINT:

Clyde D. Edwards
Clyde D. Edwards, City Administrator

APPROVED BY CITY COUNCIL: Kate Fields
Kate Fields, City Council President

APPROVED AS TO PURCHASING:

Jennifer Ryan
Jenn Ryan, Deputy Finance Director



240288

RESOLUTION NO.: _____

PRESENTED: 7-17-2024

ADOPTED: _____

Bid 2400026

BY THE CITY ADMINISTRATOR:

RESOLUTION TO CURBCO SWEEPING, INC.

The Division of Purchases and Supplies solicited bids for two-year pricing for street sweeping services, as requested by the Steet Maintenance Division, and

Curbco Sweeping, Inc., 3145 S. Dye Rd., Flint, Michigan was the sole bidder. Funding will come from the following account:

Account Number	Account Name	Amount
203-449.201-801.000	Professional Services	\$ 299,700.00
	FY25 GRAND TOTAL	\$299,700.00

IT IS RESOLVED, that the Proper City Officials are hereby authorized to enter into a contract with Curbco Sweeping, Inc. for street sweeping services, in the amount not to exceed \$299,700.00.

FOR THE CITY OF FLINT:

CLYDE D EDWARDS / A0248
CLYDE D EDWARDS / A0248 (Jul 8, 2024 15:50 EDT)
Clyde Edwards, City Administrator

APPROVED BY CITY COUNCIL:

APPROVED AS TO FORM:

William Kim
William Kim (Jul 8, 2024 15:43 EDT)
William Kim
City Attorney

APPROVED AS TO FINANCE:

Phillip Moore
Phillip Moore (Jul 8, 2024 15:38 EDT)
Phillip Moore
Chief Finance Officer

APPROVED AS TO PURCHASING:

Lauren Rowley
Lauren Rowley, Purchasing Manager

FY25 - KRN

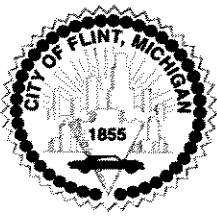

CITY OF FLINT STAFF REVIEW FORM

Revised July 2, 2024

TODAY'S DATE: July 8, 2024

BID/PROPOSAL# 24-026

AGENDA ITEM TITLE: Street Sweeping

PREPARED BY: Kathryn Neumann for Rodney McGaha, Director of Transportation

VENDOR NAME: Curbco Sweeping, Inc.

Section I: BACKGROUND/SUMMARY OF PROPOSED ACTION:

Street Maintenance requested bids to sweep the City of Flint streets. A full street sweeping has not been performed in several years. The City of Flint is awaiting new street sweepers which are scheduled to arrive in the fall of this year. Current equipment keeps breaking down and city crews are sweeping when the equipment is working. Curbco Sweeping, Inc. was the sole bidder and the price to sweep all local streets for a grand total of \$299,700.00. Getting all streets swept will allow the City of Flint a clean slate to start back sweeping streets next spring with the new equipment.

Section II. PREVIOUS ALLOCATIONS (INCLUDE ALL ACCOUNTS USED FOR THIS PURPOSE)/ PROVIDE RESOLUTION OR CONTRACT INFORMATION THAT APPLIES

None. The City has never bid out street sweeping, nor have they ever used the vendor Curbo Sweeping, Inc.

Section III. POSSIBLE BENEFIT TO THE CITY OF FLINT (RESIDENTS AND/OR CITY OPERATIONS) INCLUDE PARTNERSHIPS AND COLLABORATIONS:

The residents will have clean streets from one end of the City of Flint to the other end for the first time in several years.

Section IV: FINANCIAL IMPLICATIONS:

There is money available in the account listed below.

BUDGETED EXPENDITURE? YES NO IF NO, PLEASE EXPLAIN:

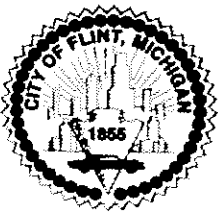

CITY OF FLINT STAFF REVIEW FORM

Revised July 2, 2024

Dept.	Name of Account	Account Number	Grant Code	Amount
Streets	Professional Services	203-449.201-801.000		\$299,700.00
FY25 GRAND TOTAL				\$299,700.00

PRE-ENCUMBERED? YES NO REQUISITION NO: 250009011

ACCOUNTING APPROVAL: Kathryn Neumann
Kathryn Neumann (Jul 8, 2024 13:23 EDT) Date: _____

WILL YOUR DEPARTMENT NEED A CONTRACT? YES NO

WHEN APPLICABLE, IF MORE THAN ONE (1) YEAR, PLEASE ESTIMATE TOTAL AMOUNT FOR EACH BUDGET YEAR: *(This will depend on the term of the bid proposal)*

BUDGET YEAR 1 \$ 299,700.00

BUDGET YEAR 2

BUDGET YEAR 3

OTHER IMPLICATIONS *(i.e., collective bargaining)*: None

STAFF RECOMMENDATION: *(PLEASE SELECT)*: **APPROVED** **NOT APPROVED**

DEPARTMENT HEAD SIGNATURE: Rodney McGaha
Rodney McGaha (Jul 8, 2024 13:39 EDT)
(Rodney McGaha, Director of Transportation)



240289

RESOLUTION NO.: _____

PRESENTED: 7-17-2024

ADOPTED: _____

PROPOSAL#24000456

BY THE CITY ADMINISTRATOR:

RESOLUTION TO HAVE COMPLETE AUTO & TRUCK PARTS, INC. FOR THE CITY OF FLINT POLICE DEPARTMENT TOWING AND STORAGE SERVICES FOR FY25

WHEREAS, The Division of Purchases and Supplies solicited proposals for towing and storage services on behalf of the City of Flint Police Department:

WHEREAS, The Police Chief has recommended that, sole bidder, Complete Auto & Truck Parts, Inc., 3401 North Dort Highway, Flint, MI be awarded the contract for these said services for FY2025.

WHEREAS, The City of Flint Police Department is requesting a contract with Complete Auto & Truck Parts, Inc. services, in a FY25 amount not to exceed \$430,000.00.

ACCOUNT NUMBER	ACCONT NAME	Amount
101-303.206-801.000	Professional Services	\$430,000.00

IT IS RESOLVED, that the Proper City Officials, upon City Council’s approval, are hereby authorized to enter into a contract with Complete Auto & Truck Parts, Inc. for the City of Flint Police Department for towing and storage services, for a total not to exceed \$430,000.00 for FY2025 (07/01/24 – 06/30/2025).

APPROVED AS TO FORM:

William Kim
William Kim (Jun 24, 2024 14:41 EDT)

William Kim, City Attorney

APPROVED AS TO FINANCE:

Phillip Moore
Phillip Moore (Jun 24, 2024 13:42 EDT)

Phillip Moore, Chief Financial Officer

FOR THE CITY OF FLINT:

CLYDE D EDWARDS / A0233
CLYDE D EDWARDS / A0233 (Jun 24, 2024 15:15 EDT)

Clyde Edwards, City Administrator

APPROVED BY CITY COUNCIL:

City Council President

APPROVED AS TO PURCHASING:

Lauren Rowley

Lauren Rowley, Purchasing Manager



CITY OF FLINT STAFF REVIEW FORM

TODAY'S DATE: 06/12/2024

BID/PROPOSAL# 24000456

AGENDA ITEM TITLE: TOWING & STORAGE – FY25

PREPARED BY: Candice Smith – Police Department

VENDOR NAME: COMPLETE AUTO & TRUCK PARTS, INC.

BACKGROUND/SUMMARY OF PROPOSED ACTION:

The City of Flint Police Department has to contract out towing and storage services and a bid was sent out to which Complete Auto & Truck Parts, Inc. was the sole bidder; therefore, the City of Flint Police Department is requesting approval from the Division of Purchases and Supplies a Purchase Order in the amount of \$430,000.00 for Fiscal Year 2025 (July 1, 2024 through June 30, 2025).

PREVIOUS ALLOCATIONS (INCLUDE ALL ACCOUNTS USED FOR THIS PURPOSE)/ PROVIDE RESOLUTION OR CONTRACT INFORMATION THAT APPLIES

N/A

POSSIBLE BENEFIT TO THE CITY OF FLINT (RESIDENTS AND/OR CITY OPERATIONS) INCLUDE PARTNERSHIPS AND COLLABORATIONS:

N/A

FINANCIAL IMPLICATIONS:

N/A

BUDGETED EXPENDITURE? YES NO IF NO, PLEASE EXPLAIN:

Dept.	Name of Account	Account Number	Grant Code	Amount
Police	Professional Services	101-303.206-801.000		\$430,000.00
			FY-25 GRAND TOTAL	\$430,000.00

PRE-ENCUMBERED? YES NO REQUISITION NO: 24-0008714

ACCOUNTING APPROVAL: Candice Smith
Candice Smith (Jun 11, 2024 11:46 EDT) **Date:** _____

WILL YOUR DEPARTMENT NEED A CONTRACT? YES NO



CITY OF FLINT STAFF REVIEW FORM

WHEN APPLICABLE, IF MORE THAN ONE (1) YEAR, PLEASE ESTIMATE TOTAL AMOUNT FOR EACH BUDGET YEAR: *(This will depend on the term of the bid proposal)*

BUDGET YEAR 1 \$

BUDGET YEAR 2

BUDGET YEAR 3

OTHER IMPLICATIONS *(i.e., collective bargaining)*:

STAFF RECOMMENDATION: *(PLEASE SELECT)*: APPROVED NOT APPROVED

DEPARTMENT HEAD SIGNATURE: Terence Green
Terence Green [Jun 24, 2024 10:34 EDT]

(Terence Green – Chief of Police)



Sheldon Neeley
Mayor

FLINT POLICE DEPARTMENT
CITY OF FLINT, MICHIGAN



Terence Green
Chief of Police

MEMORANDUM

TO: Lauren Rowley, Purchasing **DATE:** June 12, 2024
FROM: Terence Green, Chief of Police
SUBJECT: TOWING & STORAGE SERVICES – PROPOSAL 24000546

The Division of Purchases and Supplies solicited bids for Police Vehicle Towing & Storage for a one-year period. Complete Auto & Truck Parts, Inc. was the sole qualified bidder for this solicitation.

After careful review of the submitted proposal, it is the recommendation of the City of Flint Police Department to Award the above-referenced proposal to Complete Auto & Truck Parts, Inc. for a one-year period for FY25.

I am requesting that a Resolution be presented to Council for the Flint Police Department to enter into a contract for the above-mentioned amount.

If you have any questions or concerns, feel free to give me a call at (810) 237-6810.

Thank you.

Terence Green
Chief of Police



SEALED PROPOSALS RECEIVED IN THE DIVISION OF PURCHASES & SUPPLIES

Vehicle Towing/Storage

Proposal #24000546

Approximate Annual Quantities – Not Guaranteed

Furnish as requested for the period 7/1/25 – 6/30/26

**Bidder #1: Complete Auto & Truck Parts, Inc/ Complete Towing
Flint, MI**

Tow Rates/Fee Schedule

BID FORM

RATE PER SERVICE

DESCRIPTION	FY2025	FY2026
Rate to tow a car or light truck	\$ 65.00 /TOW	\$ 70.00 /TOW
Rate to tow a heavy duty vehicle (GVWR 7,000 lb. or greater)	\$ 225.00 /TOW	\$ 225.00 /TOW
Rate to tow a motorcycle	\$ 80.00 /TOW	\$ 85.00 /TOW

Rate for Accident Cleanup	\$ 70.00 /HOURLY	\$ 75.00 /HOURLY
Additional Information	\$250.00/hour	\$275.00/hour
Heavy Duty Cleanup for roll-over, etc/ or excessive man power		

Tow Rates/Fee Schedule

BID FORM

Daily Storage Fee (not to exceed 30- days for the City of Flint abandonment designation)	\$ 25.00 /DAILY	\$ 30.00 /DAILY
Additional Information	\$55.00/day	\$60.00/day

A SPECIAL NOTE FROM THE PURCHASING DIVISION

Bid results posted are before evaluation team review and award recommendation.



Medium/Heavy Storage		
----------------------	--	--

Rate for auctioneer services (this fee will be either a flat rate per vehicle or a percentage (%) of gross revenue from sales divisible by the number of vehicles auctioned)	\$ /FLAT RATE PER VEHICLE OR 3% (PERCENTAGE)	\$ /FLAT RATE PER VEHICLE OR 3% (PERCENTAGE)
Additional Information		

Use of two trucks for one tow	\$ 70.00 /EACH	\$ 75.00 /EACH
Additional Information	\$225.00/each truck	\$225.00/each truck
Heavy		

Miscellaneous tows would be towing that is requested by the City for purposes of moving vehicles during street paving season or emergency snow removal.	\$ 65.00 /EACH	\$ 65.00 /EACH
Additional Information		

A SPECIAL NOTE FROM THE PURCHASING DIVISION

Bid results posted are before evaluation team review and award recommendation.

THE FOLLOWING PAGES MUST BE COMPLETED AND INCLUDED WITH SUBMITTAL IN THE FOLLOWING ORDER.

Purchasing Checklist:

- Exhibit A - Complete Proposal Submittal with detailed Summary of Pricing
- Exhibit B - Qualifications and Licenses Requirements
- Exhibit C - Disclosure of Supplier Responsibility Statement
- Exhibit D - List of References
- Exhibit E - Certificate of Insurance
- Exhibit F - Non-Bidder's Response
- Exhibit G - City of Flint Affidavit



❖ EXHIBIT A - SUBMITTAL WITH DETAILED SUMMARY OF PRICING

SCOPE OF WORK ATTACHED SEPARATELY.

**MINIMUM SPECIFICATIONS FOR SERVICES FOR VEHICLE TOWING AND/OR STORAGE
DISPOSAL**

The City of Flint is requesting submission of proposals to provide towing and/or storage and disposal services for abandoned vehicles taken into custody under MSA 9.1952(2), Sec. 257.252, as amended; for vehicles taken under the parking provisions of Section 28-1.1 of the Flint City Code; for City vehicles disabled or reasons other than flat tires or being out of gas; for vehicles involved in police investigations and/or crime enforcement activities; and for vehicles damaged in an accident to an extent that they must be towed from the scene and owner or operator is unable to remove or cause the vehicle to be removed, and if the owner or operator does not choose a towing service to remove the vehicle.

The purpose of this proposal is to encourage competition among businesses to provide the City of Flint with the highest level of service available by a proposer who may collect reasonable towing and storage fees for vehicles administered under Section 28-1.1 of the Flint City Code by the Flint Police Department. The RFP will be used to select a primary and secondary backup towing service. In the event that the primary contract holder is unable to respond within 20 minutes of a tow request by the City of Flint Police Department, they will contact the secondary backup contractor for towing service. All proposals should be detailed to explain the advantages of their services and all associated costs.

FACILITIES

1. The Proposer "Custodian" shall have an office and storage area in compliance with local zoning ordinances. The storage area shall be surfaced and shall be so graded and drained as to dispose of all surface water and to provide a durable and without dust surface irrespective of season, capable of storing at least 250 vehicles.
2. The Proposer shall erect fencing around the storage yard and building that is at least eight (8) feet in height, and shall provide and maintain adequate illumination of the premises.
3. The Proposer shall provide and maintain a telephone line dedicated solely to the service of this agreement and personnel to answer the line at all times for the purpose of responding to calls for service from the Police Department.
4. The Proposer shall furnish inside storage capable of holding twenty (20) vehicles. This may also be used by the police to store other evidence.

EQUIPMENT

1. All wreckers shall be licensed and comply with all applicable licensing, safety, and insurance requirements of Sections 12-103, 12-106, and 12-107, respectively, of the City of Flint Code.
2. The Proposer shall furnish a sufficient number of suitably equipped wreckers of sufficient capacity so that the proposer is able to meet the twenty minute response criteria as stated under "Performance" number 2.
3. In addition to any equipment required by Section 12-106 of the Flint City Code, any non-flatbed wrecker responding to a call under this contract must be equipped with dollies and a shovel and broom for accident scene cleanup.

4. The Proposer shall furnish suitable equipment for handling vehicles in the storage area. The Proposer shall not use forklift trucks to move vehicles impounded and stored incident to this contract.

PERFORMANCE

1. The Proposer shall always have an employee on duty to permit police officials to inspect and/or process impounded vehicles at any lot.
2. The response time of the Proposer to any call shall not exceed 20 minutes.
3. The Proposer shall provide properly trained and licensed wrecker drivers. Wrecker drivers shall clean the street as provided in Section 12-112 of the Flint City Code, whenever removing a vehicle from an accident scene, and shall clear the street of debris related to the tow when necessary at other towing scenes at no cost to the City.
4. Upon request of the Police Department, the Proposer will immediately dispatch suitable equipment to all designated vehicles to wherever the driver or owner designates, or, if the owner or driver is not able to designate or fails to designate a destination; or, if the Police Department has decided to impound the vehicle, then to the Proposer's appropriate vehicle storage area, or other area designated by the Chief of Police/or Designee.
5. Vehicles to be towed shall be identified to the Proposer by a member of the Flint Police Department, and except for vehicles of the Police Department and vehicles held as evidence of a crime, an inventory of the vehicle and its contents shall be taken by the police officer and a representative of the Proposer, to include a listing of any damage. This shall be accomplished by visual inspection and recorded on a standard impound form furnished by the Flint Police Department, and signed by the police officer and the wrecker driver immediately.
6. Upon arrival at the storage area, the Proposer shall prepare a standard impound card, completing all information requested on the card, and thereafter updating the information as necessary. The completed card must be available for the Police Department's review for all vehicles impounded in the prior twenty-four hour period no later than 8:00 am, Monday through Saturday, and maintained in an orderly, business-like filing system.
7. The Proposer shall provide a minimum of two yard personnel at all storage sites during regular business hours (must be open Mon-Sat, 9 am - 6 pm, except Holidays) for the purpose of escorting customers to and from their vehicles to maintain the security of the yard.
8. Impounded vehicles to be preserved as evidence of a crime will not be entered or driven by any employee or agent of the Proposer until the vehicle has been processed by the Police Department or Crime Lab. In the event it becomes necessary to move evidence vehicles, this will only be accomplished with a tow truck or tow motor furnish by the Proposer, unless specifically directed otherwise by the officer in charge of the criminal investigation at no cost to the City.
9. The Proposer shall protect any impounded vehicle from theft, vandalism or damage of any type as specified in Section 12-110 of the Flint City Code, and is solely responsible for any damage, theft or vandalism occurring subsequent to taking custody of the vehicle.
10. No impounded vehicles or seized vehicle shall be released from the storage area without

the proper release form or release authorization provided by the Flint Police Department for such purposes. When a vehicle is towed to the Proposer's vehicle storage area, and is not being held as evidence of a crime, nor is it impounded by the Police Department, nor is it a Police vehicle, nor a vehicle used in connection with Police business, the Proposer must release the vehicle to the owner upon payment of the charges as provided in the proposal.

11. Every Wednesday morning before 10:0 A.M., the Proposer will furnish the Police Department, on a form provided by the Flint Police Department, with a list of vehicles which are currently on their lot towed pursuant to this agreement. The Police Department will then furnish the Proposer with a TR52 form for vehicles not held as evidence or forfeiture vehicles, with the notation that the vehicles are to be sold at Public Auction. With the authorization from the Police Department, the Proposer is then solely responsible for the disposal of unclaimed vehicles according to current law governing said vehicles with no compensation by the City, unless otherwise notified by the City.
12. The Proposer shall provide towing for City of Flint Police vehicles and those vehicles used in connection with City business, free of charge, except for those that are disabled solely because (a) they are out of gas, or (b) they have a flat tire. This free towing shall be limited to vehicles towed from and to any location within 20 miles of the Flint City limits.
13. All evidence vehicles and drug forfeiture vehicles shall be towed and stored free of charge. Storage fees for these vehicles, if released to the owner, will not begin to accrue until the hold on the vehicle has been released by the Chief of Police/or Designee.
14. When a fee waiver is submitted with ~~by~~ authorization of the Chief of Police/~~or~~ Designee, no fee shall be charged other than said amount on the waiver, for the release of the vehicle to the owner or the City of Flint as of said date. For any day proceeding the date of the waiver that the owner does not pick up their property, will incur accrued fees according to the daily fee.
15. Proposer agrees it will not scrap, sell, damage or alter any vehicle impounded by the City of Flint until approved by the Chief of Police or Designee. In the event that a Court of competent jurisdiction or City Attorney orders an impounded vehicle to be returned to the owner without cost, the vehicle will be released at no cost to the owner or the City of Flint. The Proposer further agrees that it will compensate the owner of any impounded vehicle that Proposer scraps, sells, damages, or alters prior to receiving authorization from the aforementioned.
16. The Proposer shall be responsible to assure that all of the employees and agents performing work under this agreement comply with all of the provisions of this agreement including those governing charges for service provided under this agreement.
17. The Proposer must furnish the City with copies of Business Licenses and Insurance Certificates which are to be attached to the proposal at the time it is submitted. The Proposer agrees to update the City, in writing and with copies of certificates of insurance, if there is any change in insurance coverage or supplier during the term of this agreement.
18. In the event that the City requires towing of a vehicle with a rated load capacity in excess of one ton, or a trailer with a length in excess of 16 feet, and the proposer does not have the capability to tow the vehicle or trailer, the City shall have the vehicle towed by a company capable of handling the tow at the sole discretion of the City.

MICHIGAN VEHICLE CODE (EXCERPT)
Act 300 of 1949

257.25g Manner of conducting public sale; application of money received; priority; absence of bidders; acquisition of distressed vehicle; application for salvage certificate of title; canceling entry in law enforcement information network; obtaining original bill of sale.

Sec.252g. (1) Subject to section 252a(16), a public sale for a vehicle and its contents that has been determined to be abandoned under section 252a or removed under section 252d shall be conducted in the following manner:

- (a) It shall be under the control of the police agency. However, a police agency may designate the custodian of the vehicle or a third party to conduct the auction.
- (b) It shall be open to the public and consist of open auction bidding or bidding by sealed bids.

If sealed bids are received, the person submitting the bid shall receive a receipt for the bid from the police agency or the agency's designee or, if the vehicle is being sold under section 252a (16), the custodian of the vehicle.

- (c) Except as otherwise provided in sections 252a (16) and (17) and 252b (7), it shall be held not less than 5 days after public notice of the sale has been published.
- (d) The public notice shall be published at least once in a newspaper having a general circulation within the county in which the vehicle was abandoned. The public notice shall give a description of the vehicle for sale and shall state the time, date, and location of the sale.

(2) The money received from the public sale of the vehicle shall be applied in the following order of priority:

(a) Accrued towing and storage charges. *However, if the money received from the public sale does not satisfy the accrued towing and storage charges, the towing company may collect the balance of those unpaid fees from the last titled owner, subject to section 252i.*

(b) Expenses incurred by the police agency or the custodian of the vehicle.

(c) Payment of the \$40.00 abandoned vehicle fee described in section 252f (3) (a).

(d) Any extra money shall be sent to the department of treasury's unclaimed property division to be disbursed as follows:

- (i) To the secured party, if any, in the amount of the debt outstanding on the vehicle.
- (ii) Remainder to the owner. A reasonable attempt shall be made to mail the remainder to the last titled owner. If delivery of the remainder cannot be accomplished, the remainder shall become the property of the unit of government governing the location from which the vehicle was towed.

(3) If there are no bidders on the vehicle, the police agency or the custodian of the vehicle may do one (1) of the following:

(a) Turn the vehicle over to the towing firm or the custodian of the vehicle to satisfy charges against the vehicle. However, if the value of the vehicle does not satisfy the towing fees and accrued daily storage fees, the custodian of the vehicle may collect the balance of those unpaid fees from the last titled owner, subject to section 252i.

- (b) Obtain title to the vehicle for the police agency or the unit of government the police agency represents, by doing the following:
 - (i) Paying the towing and storage charges.
 - (ii) Applying for title to the vehicle.
- (c) Hold another public sale under subsection (1).
- (4) A person who acquires ownership of a vehicle under subsection (1) or (3) that has been designated as a distressed vehicle shall apply for a salvage certificate of title within 15 days after obtaining the vehicle.
- (5) Upon disposition of the vehicle, the police agency or towing agency or custodian shall provide the secretary of state and the police agency, if that police agency did not conduct the sale, with the vehicle's disposition and the name of the agency that disposed of it and the police agency shall cancel the entry in the law enforcement information network.
- (6) Not less than 25 days after the date of notice required under section 252a, if the police agency does not provide a copy of the bill of sale by the police agency for the abandoned vehicle to the towing agency or custodian or police agency's designee, the towing agency or custodian or police agency designee may obtain an original of the bill of sale by submitting an application to the secretary of state in a form as determined by the secretary of state.

AUCTION

An auction shall be held pursuant to MCLA 257.252(a) (9) and 257.252(d)(6), and 257.252 (g) in order to dispose of any vehicles which have not been released, redeemed, or declared "abandoned scrap vehicle" and were towed pursuant to this contract. **Any proceeds of sale after the impound facility towing and storage fees (maximum collectable storage fee may not exceed 30-days for abandoned vehicle designation) along with auctioneer service fees shall be invoiced and supplied with the list by VIN and impound number of all vehicles auctioned.**

All billings and lists shall be forwarded to the office of the Chief of Police prior to any withholding and accounting of the referenced fees. Such documentation shall be provided no later than 72 hours after the completion of auction. Pursuant to MCLA 257.252(g), the City of Flint will only return that amount in total that was bid on any auction vehicle in satisfaction of the towing, 30-day storage and vehicle title (if available) or the Michigan Department of State Request for TR-52L Abandoned Vehicle/Vessel Bill of Sale in satisfaction of an abandoned vehicle will be provided by The City of Flint to the Proposer or impound facility. As allowed under statute, any fees or amounts over and above the bid total uncollected from the City of Flint may be pursued for collection by the impounding facility from the last titled vehicle owner (Section 257.252g (2) (a) subject to section 252i).

- The Proposer shall provide the following services in connection with the auction process:**
- **Provide a reasonable attempt to insure the vehicles scheduled for auction will start, such as charging the battery and providing fuel.**
 - **Provide assistance in crowd control, security of the keys for the vehicles, and conduct a review of the scheduled auction vehicles with the auction participants prior to the auction. A minimum of one hour should be allowed for this process to take place.**

- Provide personnel to start vehicles when it is scheduled for auction and control the keys to insure successful bidder receives them.

Tow Rates/Fee Schedule

It is the intent of the City to seek and evaluate proposal submissions for providing towing services on a continuous basis 24 hrs./day 7 days/week over a one-year period with the option to renew an additional two-years upon mutual acceptance of contract parties. Those submitting proposals are requested to submit pricing for the continuation of said services for the one-year period and propose additional year's pricing on a separate sheet with business letterhead and signed by a duly authorized agent or employee of the Proposer. Vehicles will be taken into custody under MSA 9.1.1952(2), Sec. 257.252, as amended; for vehicles taken under the parking provisions of Section 28-1.1 of the Flint City Code; for vehicles disabled for reasons other than flat tires or being out of gas; for vehicles involved in police investigations and/or crime enforcement activities; and for vehicles damaged in an accident to an extent that they must be towed from the scene and the owner/operator is unable to remove or cause the vehicle to be removed, and if the owner or operator does not choose a towing service to remove the vehicle.

The City is requesting vendors to provide a price to tow vehicles, daily rate to store vehicles, and auction service fees to the City to carry out these tasks. Vendor is to list any additional fees either on this document or on a separate piece of paper that will be assessed for this service.

The undersigned hereby certifies that he/she has read the specifications for Vehicle Towing Services - City of Flint and submits the following prices:

Tow Rates/Fee Schedule

BID FORM

Complete Towing

RATE PER SERVICE

DESCRIPTION	FY2024-25	FY2025 26
Rate to tow a car or light truck	\$ 65.00/TOW	\$ 70.00 /TOW
Rate to tow a heavy duty vehicle (GVWR 7,000 lb. or greater)	\$ 225.00 /TOW	\$ 225.00 /TOW
Rate to tow a motorcycle	\$ 80.00 /TOW	\$ 85.00 /TOW

Rate for Accident Cleanup	\$ 70.00/HOURLY	\$ 75.00 /HOURLY
---------------------------	-----------------	------------------

Additional Information Heavy Duty Cleanup for roll-over, etc. or excessive man power	\$250.00/Hour	\$275.00/Hour
---	---------------	---------------

Tow Rates/Fee Schedule
BID FORM

Daily Storage Fee (not to exceed 30-days for the City of Flint abandonment designation)	\$ 25.00 /DAILY	\$ 30.00 /DAILY
Additional Information Medium/Heavy Storage	\$55.00/day	\$60.00/day

Rate for auctioneer services (this fee will be either a flat rate per vehicle or a percentage (%) of gross revenue from sales divisible by the number of vehicles auctioned)	\$ /FLAT RATE PER VEHICLE OR 3% % (PERCENTAGE)	\$ /FLAT RATE PER VEHICLE OR 3% % (PERCENTAGE)
Additional Information	Please see attached	auction addendum details.

Use of two trucks for one tow	\$ 70.00 /EACH	\$ 75.00 /EACH
Additional Information Heavy	\$225.00/ each truck	\$225.00/each truck

Miscellaneous tows would be towing that is requested by the City for purposes of moving vehicles during street paving season or emergency snow removal.	\$ 65.00 /EACH	\$ 65.00 /EACH
Additional Information		

--	--	--

Tow Rates/Fee Schedule
BID FORM

Stated Mandated Fees	N/A - City of Flint	collects all impound fees
1. Abandoned Vehicle Fee collected from last registered owner.	\$ /EACH	\$ /EACH
2. Secretary of State Processing Fee	\$ /EACH	\$ /EACH
<i>**Should any vehicle be released for salvage/Auction to the impound facility agent, these fees will not be assessed as part of the total fee values to the City of Flint.</i>		
Additional Information		



COMPLETE AUTO & TRUCK PARTS, INC.

COMPLETE TOWING

June 3, 2024

City of Flint
Finance Department
Division of Purchases and Supplies
1101 S Saginaw Street, Room 203
Flint, MI 48502

RE: Request for Proposal No. P24000546
Vehicle Towing and Storage

Exhibit A
Additional Information for Proposal and Third Year Rates

Complete Towing is the best company to provide the services requested. We have all the facilities, equipment, and personnel already in place. There will be no start-up delays or confusion because we have been running an impound yard for over 35 years. Our yard has enough storage space to store more than 500 vehicles, which exceeds the space requested. In addition to being experienced and fully capable of managing the towing and storage according to your requirements we also provide the following services and benefits to the City of Flint and its community:

1. We have staff on duty 24 hours a day for security along with camera surveillance to protect the vehicles impounded by the City of Flint.
2. We allow Flint Fire Dept. to use our premises for training: (see attached photos)
 - Jaws of Life
 - Any type of training where cars are needed
 - We supply the vehicles for them to destroy
 - And make them user friendly by removing batteries, gas tanks, and antifreeze – making sure there are no contaminants leaking on the ground or any fire hazard.
3. We allow the Flint Police Dept to bring out their advanced accident class so they can train on the crash vehicles
4. We allow the Flint Police Dept to bring in their K-9 units for training (see photos)
5. We allow the Flint Police Dept the use of our inside hoist whenever it is needed for their investigation

3401 N. Dort Highway • Flint, MI 48506 • Towing (810) 235-1711 • Fax (810) 235-8144
Parts (810) 235-9166 • Toll Free (888) 235-9100 • www.completetowing.us

Towing • Used parts • Industrial Equipment • Auto & Truck Sales • Parts Locator Service • Storage Containers

24 HOUR TOWING • USED PARTS

6. We offer assistance through our on-duty mechanics, with the removal of automobile parts from evidence vehicles, under the direction of the Officer in charge of the case.
7. We store equipment at the request of FPD at no charge to the city.
8. We assist the impound officer whenever needed

Third year rates for FY 2027:

All rates will be the same as quoted for FY 2026 with one exception:

Rate to tow a car or light truck: FY 2027 will be \$75.00/tow

Also, if we may be so bold, one improvement we would like to suggest is that we be informed on a weekly basis which impound vehicles the City of Flint has released. This would allow us to better track the vehicles you store at our facility and let you know if there is a vehicle here you assume is picked up, but it isn't and thus perhaps preventing the need for a duplicate TR52.

We feel it is a privilege and appreciate the opportunity to continue to provide towing, storage, and these value-added services for the City of Flint. If there are any questions regarding our proposal, please call me at 810-235-1711 or email me at admin@completetowing.us.

Sincerely,
Complete Auto & Truck Parts, Inc.
Complete Towing



James D. Patton

JP/pb

(This letter is a supplemental attachment to the RFP # 24000546)



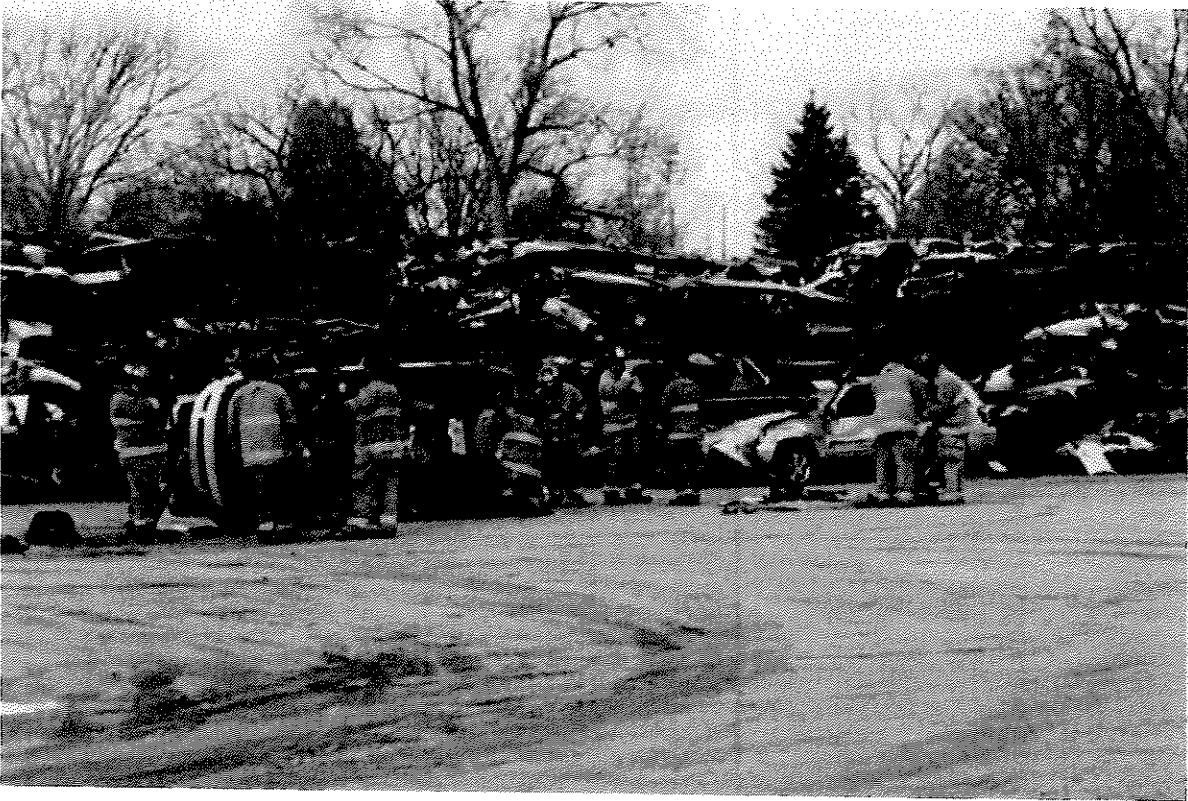

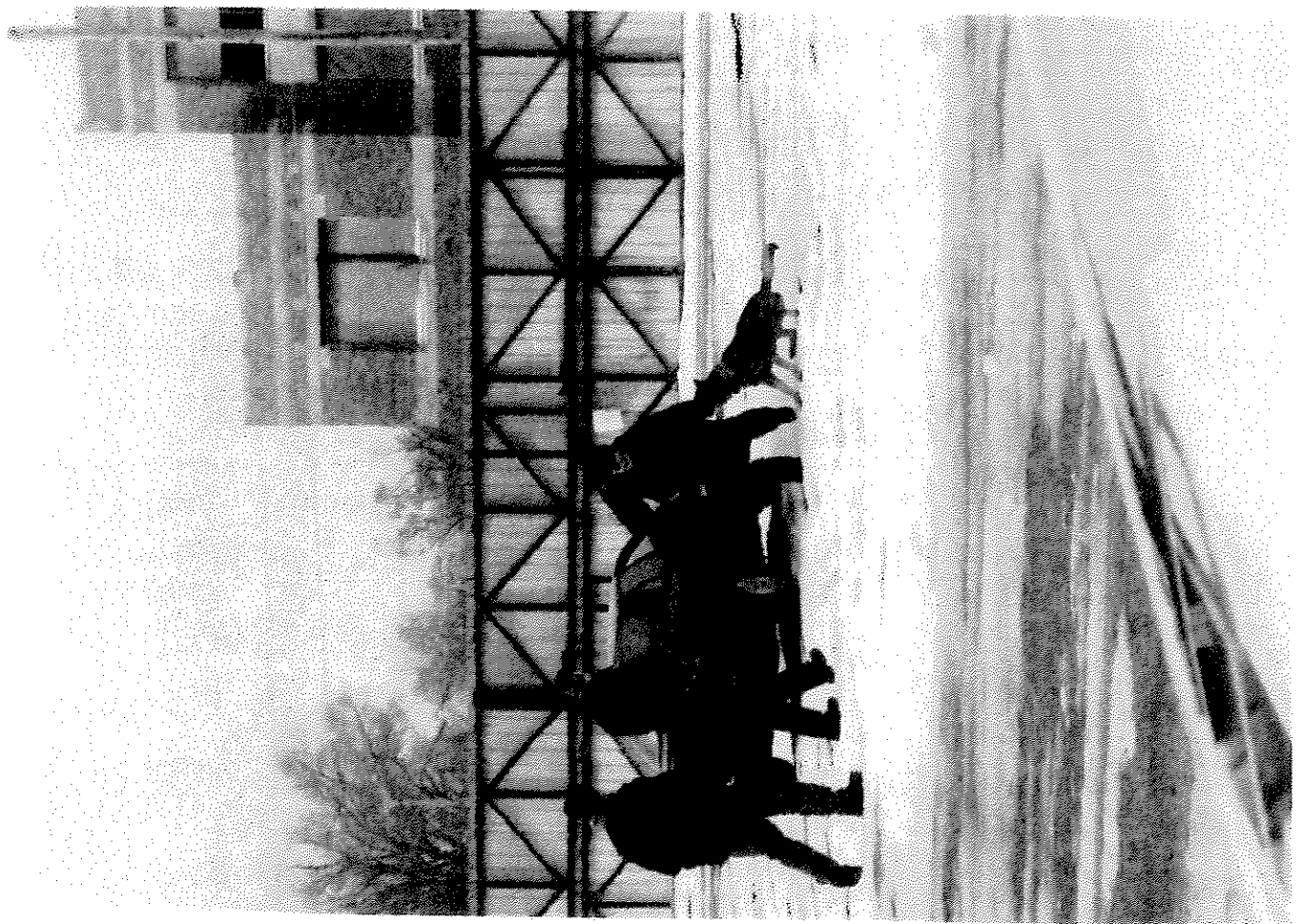



COMPLETE TOWING
3401 N. Dort Hwy
Flint, MI 48506

AUCTION ADDENDUM

Excerpt from Proposal:

"Auction

An auction shall be held pursuant to MCLA 257.252(a) (9) and 257.252 (d) (6), and 257.252 (g) in order to dispose of any vehicles which have not been released, redeemed, or declared "abandoned scrap vehicle" and were towed pursuant to this contract. **Any proceeds of sale after the impound facility towing and storage fees (maximum collectable storage fee may not exceed 30-days for abandoned vehicle designation) along with auctioneer service fees shall be invoiced and supplied with the list by VIN and impound number of all vehicles auctioned."**

The auction services we provide after a Flint Police Officer checks the vehicle for eligibility for auction will include the following:

- Place the vehicle in a separate lot for auction
- Remove the license plates
- Contract with a licensed professional auctioneer
- Pay the auctioneer
- Schedule the auction on a date agreeable to the City of Flint
- Contract for and pay for the advertising in the Flint Journal and on M-Live
- Publicize the auction on our website - including a list of vehicles
- Provide personnel during the auction to secure the cars from theft or damage
- Provide personnel during the auction to assist with bidders' questions
- Provide personnel for the three days following the auction for release of vehicles
- Record and report auction results within 72 hours of completion

As compensation for these services, we agree to accept the terms explained in the proposal. We will charge the City of Flint the towing fee and the 30 days storage and the auctioneer fee (3.0%) for each vehicle up to, but not to exceed, the total bid amount each vehicle sold for at auction.

However, because this RFP is an abrupt deviation from the way these auction proceeds were handled historically, we would just like to point out another method of calculating the fees for managing these auctions would be to simply bill the City of Flint Sixty Percent (60%) of total auction proceeds. Either method is acceptable to Complete Towing.

EXHIBIT B - QUALIFICATIONS AND LICENSES REQUIREMENTS

Please give a synopsis of your qualifications and experience with this service:

Please see included letter

Please list Licenses:

CDL or Chauffer license for all tow operators
Sales Tax License, Dealer License, Repair Facility License
Salvage Vehicle Agent License
Junk Dealer License

How long have you been in business?

Since 1985

Have you done business with the City of Flint?

Yes

If yes, please state the project name.

Impound Towing and Storage
Heavy Towing Services
Vehicle Inspections

EXHIBIT C – DISCLOSURE OF SUPPLIER RESPONSIBILITY STATEMENT

1. List any convictions of any person, subsidiary, or affiliate of the company, arising out of obtaining, or attempting to obtain a public or private contract, or subcontract, or in the performance of such contract or subcontract.

N/A

2. List any convictions of any person, subsidiary, or affiliate of this company for offenses such as embezzlement, theft, fraudulent schemes, etc. or any other offense indicating a lack of business integrity or business honesty which affect the responsibility of the contractor.

N/A

3. List any convictions or civil judgments under state or federal antitrust statutes.

N/A

4. List any violations of contract provisions such as knowingly (without good cause) to perform, or unsatisfactory performance, in accordance with the specifications of a contract.

N/A

5. List any prior suspensions or debarments by any government agency.

N/A

6. List any contracts not completed on time.

N/A

7. List any documented violations of federal or state labor laws, regulations or standards, or occupational safety and health rules.

N/A

**❖ EXHIBIT D – LIST OF REFERENCES: (3) SIMILAR SCOPE OF WORK FROM
THE LAST 5 YEARS**

Providing the following contact information enables the City of Flint to contact those accounts as references.

Reference #1:

Company/Municipality: Flint Police Department
Contact Person: Terence Green Title: Chief
Address: 210 E Fifth Street
City: Flint State: MI Zip: 48502
Telephone: 810-237-6868 Fax: _____
Email: _____
Type of Project: Towing and Recovery and Impound Storage and Auction

Project Timeline (Dates): 39 years Budget: _____

Reference #2:

Company/Municipality: Genesee County Sheriff Department
Contact Person: Chris Swanson/Robert Pickell ^(prior) Title: Sheriff
Address: 1002 S Saginaw St
City: Flint State: MI Zip: 48503
Telephone: 810-257-3406 Fax: _____
Email: _____
Type of Project: Towing and Recovery and Impound Storage

Project Timeline (Dates): 39 Years Budget: _____

❖ EXHIBIT D – LIST OF REFERENCES: (3) SIMILAR SCOPE OF WORK FROM
THE LAST 5 YEARS (CONTINUES)

Reference #3:

Company/Municipality: Gain Auto Theft

Contact Person: Chris Swanson Title: Sheriff

Address: 1002 S Saginaw St

City: Flint State: MI Zip: 48502

Telephone: 810-257-3422 Fax: _____

Email: _____

Type of Project: Towing and Recovery Storage and Impound

Project Timeline (Dates): 19 years Budget: _____

RFP 24000546



CERTIFICATE OF LIABILITY INSURANCE

DATE (MM/DD/YYYY)
5/24/2024

THIS CERTIFICATE IS ISSUED AS A MATTER OF INFORMATION ONLY AND CONFERS NO RIGHTS UPON THE CERTIFICATE HOLDER. THIS CERTIFICATE DOES NOT AFFIRMATIVELY OR NEGATIVELY AMEND, EXTEND OR ALTER THE COVERAGE AFFORDED BY THE POLICIES BELOW. THIS CERTIFICATE OF INSURANCE DOES NOT CONSTITUTE A CONTRACT BETWEEN THE ISSUING INSURER(S), AUTHORIZED REPRESENTATIVE OR PRODUCER, AND THE CERTIFICATE HOLDER.

IMPORTANT: If the certificate holder is an ADDITIONAL INSURED, the policy(ies) must have ADDITIONAL INSURED provisions or be endorsed. If SUBROGATION IS WAIVED, subject to the terms and conditions of the policy, certain policies may require an endorsement. A statement on this certificate does not confer rights to the certificate holder in lieu of such endorsement(s).

PRODUCER The Campbell Group 4808 Broadmoor Ave SE Kentwood MI 49512	CONTACT NAME: Sarah Bednarsky PHONE (A/C No, Ext): 800-748-0351 ext 1379 FAX (A/C No): 800-847-3129 E-MAIL ADDRESS: sbednarsky@thecampbellgrp.com
INSURED Complete Auto & Truck Parts Inc DBA Complete Towing 3401 N Dort Hwy Flint MI 48506	COMPACT-06 INSURER A : Fremont Insurance Company INSURER B : INSURER C : INSURER D : INSURER E : INSURER F :
INSURER(S) AFFORDING COVERAGE NAIC # _____ 13994	

COVERAGES **CERTIFICATE NUMBER: 26851289** **REVISION NUMBER:**

THIS IS TO CERTIFY THAT THE POLICIES OF INSURANCE LISTED BELOW HAVE BEEN ISSUED TO THE INSURED NAMED ABOVE FOR THE POLICY PERIOD INDICATED. NOTWITHSTANDING ANY REQUIREMENT, TERM OR CONDITION OF ANY CONTRACT OR OTHER DOCUMENT WITH RESPECT TO WHICH THIS CERTIFICATE MAY BE ISSUED OR MAY PERTAIN, THE INSURANCE AFFORDED BY THE POLICIES DESCRIBED HEREIN IS SUBJECT TO ALL THE TERMS, EXCLUSIONS AND CONDITIONS OF SUCH POLICIES. LIMITS SHOWN MAY HAVE BEEN REDUCED BY PAID CLAIMS.

INSR LTR	TYPE OF INSURANCE	ADDL INSD	SUBR WVD	POLICY NUMBER	POLICY EFF (MM/DD/YYYY)	POLICY EXP (MM/DD/YYYY)	LIMITS
A	COMMERCIAL GENERAL LIABILITY CLAIMS-MADE <input checked="" type="checkbox"/> OCCUR GEN'L AGGREGATE LIMIT APPLIES PER: <input checked="" type="checkbox"/> POLICY <input type="checkbox"/> PRO-JECT <input type="checkbox"/> LOC OTHER:	Y	Y	CPP 0082035	5/30/2024	5/30/2025	EACH OCCURRENCE \$ 2,000,000 DAMAGE TO RENTED PREMISES (Ea occurrence) \$ 100,000 MED EXP (Any one person) \$ 5,000 PERSONAL & ADV INJURY \$ 2,000,000 GENERAL AGGREGATE \$ 4,000,000 PRODUCTS - COMPIOP AGG \$ 4,000,000 \$
A	AUTOMOBILE LIABILITY <input checked="" type="checkbox"/> ANY AUTO <input type="checkbox"/> OWNED AUTOS ONLY <input type="checkbox"/> SCHEDULED AUTOS NON-OWNED AUTOS ONLY <input checked="" type="checkbox"/> HIRED AUTOS ONLY <input checked="" type="checkbox"/>	Y	Y	CAP 0028516	5/30/2024	5/30/2025	COMBINED SINGLE LIMIT (Ea accident) \$ 1,000,000 BODILY INJURY (Per person) \$ BODILY INJURY (Per accident) \$ PROPERTY DAMAGE (Per accident) \$ \$ UMBRELLA LIAB <input type="checkbox"/> OCCUR EXCESS LIAB <input type="checkbox"/> CLAIMS-MADE DED RETENTION \$ EACH OCCURRENCE \$ AGGREGATE \$ \$
A	WORKERS COMPENSATION AND EMPLOYERS' LIABILITY ANY PROPRIETOR/PARTNER/EXECUTIVE OFFICER/MEMBER EXCLUDED? (Mandatory in NH) If yes, describe under DESCRIPTION OF OPERATIONS below	Y/N	N/A	WCP 0020073	5/30/2024	5/30/2025	<input checked="" type="checkbox"/> PER STATUTE <input type="checkbox"/> OTH-ER E.L. EACH ACCIDENT \$ 100,000 E.L. DISEASE - EA EMPLOYEE \$ 100,000 E.L. DISEASE - POLICY LIMIT \$ 500,000
A	Garage Keepers On Hook/ Cargo Coverage			CPP 0082035	5/30/2024	5/30/2025	50,000 50,000

DESCRIPTION OF OPERATIONS / LOCATIONS / VEHICLES (ACORD 101, Additional Remarks Schedule, may be attached if more space is required)
 Garage Keepers Legal Liability coverage includes \$2,500 comprehensive and collision deductibles.
 City of Flint, and including all elected and appointed officials, all employees and volunteers, all boards, commissions and/or authorities and their board members, employees and volunteers are considered additional insured;s with respects to general and auto liability coverage as long as required within a written contract. Coverage is primary and non-contributory as it applies to general liability.

CERTIFICATE HOLDER City of Flint 1101 South Saginaw Street Flint MI 48502	CANCELLATION SHOULD ANY OF THE ABOVE DESCRIBED POLICIES BE CANCELLED BEFORE THE EXPIRATION DATE THEREOF, NOTICE WILL BE DELIVERED IN ACCORDANCE WITH THE POLICY PROVISIONS. AUTHORIZED REPRESENTATIVE
---	--

❖ EXHIBIT F – NON-BIDDER’S RESPONSE

VENDOR’S NAME: Complete Towing (N/A – We are bidding)

NON-BIDDER’S RESPONSE

For the purpose of facilitating your firm’s response to our invitation to bid, the City of Flint is interested in ascertaining reasons for prospective bidder’s failure to respond to “Invitations to Bid”. If your firm is not responding to this bid, please indicate the reason(s) by checking any appropriate item(s) below and return this form to the above address.

We are *not* responding to this “Invitation to Bid” for the following reason(s):

_____ Items or materials requested not manufactured by us or not available to our company.

_____ Our items and/or materials do not meet specifications.

_____ Specifications not clearly understood or applicable (too vague, too rigid, etc.).

_____ Quantities too Small.

_____ Insufficient time allowed for preparation of bid.

_____ Incorrect address used. Our correct mailing address is:

_____ Our branch / division handles this type of bid. We have forwarded this bid on to them but for the future the correct name and mailing address is: _____

_____ OTHER: _____

Thank you for your participation in this bid.

❖ EXHIBIT G – CITY OF FLINT AFFADAVIT

FOR CORPORATION

STATE OF Michigan

S.S.

COUNTY OF Genesee

James D Patton being duly sworn, deposes and says that she/he/they
is President of Complete Auto & Truck Parts, Inc., d/b/a Complete Towing
(Official Title) (Name of Corporation)

a corporation duly organized and doing business under the laws of the State of Michigan
the corporation making the within and foregoing bid; that they executed said bid in behalf of said corporation by
authority of its Board of Directors; that said bid is genuine and not sham or collusive and is not made in the
interests of or on behalf of any person not herein named, and that they have not and said bidder has not directly
or indirectly induced or solicited any other person or corporation to refrain from bidding; that they have not and
said bidder has not in any manner sought by collusion to secure to themselves or to said corporation an advantage
over other bidders.

Subscribed and sworn to before me at Complete Towing, in said County and State,
this 3 day of June, A.D. 20 24,

Peggy Buby

*Notary Public, Genesee County, MI
My Commission expires 3/30, 20 25

240290



RESOLUTION NO.: _____

PRESENTED: 7-17-2024

ADOPTED: _____

RESOLUTION APPROVING A BUDGET AMENDMENT AND AUTHORIZATION FOR THE CITY OF FLINT TO ACCEPT A \$1,000,000.00 GRANT FROM THE US ENVIRONMENTAL PROTECTION AGENCY

BY THE MAYOR:

Whereas, The City of Flint was awarded funding from the Environmental Protection Agency (grant number: OOE03636), and

Whereas, the amount awarded is \$1,000,000, and

Whereas, the grant will extend for three (3) years, from June 1, 2024 to May 31, 2027, and

Whereas, the cumulative awarded amount may be \$1,000,000, and

Whereas, the grant is awarded to the City of Flint, as the fiduciary, and five community partner organizations, to support the environmental justice efforts of the US Environmental Protection Agency to facilitate a community engagement process that will result in a Flint Climate Change and Resiliency Plan;

Account Number	Account Name	Amount
296-704.750-702.010	WAGES - FULL-TIME (NON-EXEMPT)	\$214,375
296-704.750-702.020	SALARIED EMPLOYEE (EXEMPT)	\$13,625
296-704.750-705.000	SICK, VACATION AND ACCRUED LEAVE PAY	0
296-704.750-706.000	HOLIDAY PAY	\$5,412
296-704.750-710.100	UNEMPLOYMENT COMPENSATION (SUTA)	\$3,675
296-704.750-710.200	FICA (SOCIAL SECURITY)	\$6,635
296-704.750-710.300	MEDICARE	\$3,901
296-704.750-713.000	WORKERS COMPENSATION	\$886
296-704.750-714.300	EMPLOYER HEALTH CARE SAVINGS PLAN (HCSP)	\$5,922
296-704.750-716.100	MERS HYBRID DEFINED CONTRIBUTION PENSION	\$9,607
296-704.750-717.100	MERS HYBRID DEFINED BENEFIT PENSION	\$14,316
296-704.750-718.010	HEALTH INSURANCE PREMIUMS	\$33,531
296-704.750-718.300	LIFE INSURANCE	\$986
296-704.750-718.400	OPTICAL INSURANCE	\$754
296-704.750-718.500	DENTAL INSURANCE	\$1,823
296-704.750-719.100	ACCRUED ABSENCES	\$2,280
296-704.750-801.000	PROFESSIONAL SERVICES	\$540,000
296-704.750-802.000	CONTRACTUAL SERVICES	\$90,000
296-704.750-969.100	INDIRECT COST ALLOCATION	\$52,272
	Total:	\$1,000,000

IT IS RESOLVED that the appropriate City officials are authorized to do all things necessary to abide by the terms of the Environmental Justice Government – to – Government (EJG2G) grant # OOE03636 in the amount of \$1,000,000.00 for three (3) years total, to appropriate revenue and expenditure amounts using grant code FEPA-EVG2G24, and to make the grant funds available in the current and any subsequent fiscal years that funding continues to remain available by the grantor.

ADMINISTRATION:

Approved as to Form:

William Kim (Jul 9, 2024 15:47 EDT)

William Kim, City Attorney

Approved as to Finances:

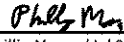
Phillip Moore (Jul 9, 2024 16:01 EDT)

Phillip Moore, Chief Financial Officer

For the City of Flint:

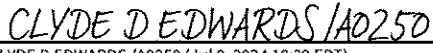
CLYDE D EDWARDS /A0250
CLYDE D EDWARDS /A0250 (Jul 9, 2024 18:39 EDT)

Clyde Edwards, City Administrator

Approved by City Council:



CITY OF FLINT STAFF REVIEW FORM

Revised July 2, 2024

TODAY'S DATE: July 5, 2024

BID/PROPOSAL#: N/A

AGENDA ITEM TITLE: RESOLUTION APPROVING A BUDGET AMENDMENT AND AUTHORIZATION FOR THE CITY OF FLINT TO ACCEPT A \$1,000,000.00 GRANT FROM THE US ENVIRONMENTAL PROTECTION AGENCY

PREPARED BY: Faith Groesbeck

VENDOR NAME: N/A

Section I: BACKGROUND/SUMMARY OF PROPOSED ACTION:

More than two years before this grant was written and submitted, the City of Flint was an active participant of a sustainability group that included representatives from supporting organizations and subawardees. This group's collaborative efforts led to the recognition that to meet their sustainability goals, funding to support a community engagement process to create a Climate Change and Resiliency Plan for the City of Flint would need to be secured. Therefore, in the Spring of 2023, the group's efforts shifted focus to completing an application for the Environment Protection Agency's Environmental Justice Government-to-Government grant.

The accepted project includes collaborating with community and academic partners to facilitate the creation of a Climate Change and Resiliency plan for the City of Flint that accurately reflects the desires and needs of its residents. The plan will be integrated into existing plans, like Imagine Flint, to guide future allocation of resources, prepare for the impacts of climate change, and equitably build resiliency into the planning, development, and public health efforts of city government. Such a plan will be necessary to align goals with the MI Healthy Climate Plan and seek additional implementation funding at the state and federal levels.

Section II. PREVIOUS ALLOCATIONS (INCLUDE ALL ACCOUNTS USED FOR THIS PURPOSE)/ PROVIDE RESOLUTION OR CONTRACT INFORMATION THAT APPLIES

N/A

Section III. POSSIBLE BENEFIT TO THE CITY OF FLINT (RESIDENTS AND/OR CITY OPERATIONS) INCLUDE PARTNERSHIPS AND COLLABORATIONS:

The City of Flint has been overburdened by environmental pollution and racism for decades. Examples include challenges with housing safety and affordability, legacy pollution from manufacturing, the Flint Water Crisis, hazardous chemicals polluting waterways, concentrated industrial activity in racially segregated neighborhoods and resulting health disparities, and widespread blight and illegal dumping. In part, for these stated reasons, the City of Flint's Charter includes the affirmation of

CDE/ authorized administration version

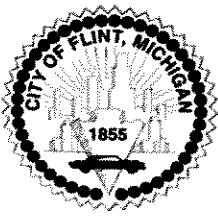

CITY OF FLINT STAFF REVIEW FORM

Revised July 2, 2024

environmental justice as a value to uphold. Once the grant activities commence, there will be many opportunities for all residents to participate in events, provide input, listen to the needs of other community members, and act on environmental and climate concerns.

This grant includes three years of funding for a Sustainability Coordinator for the City of Flint that will administer this project, increase the capacity to seek out and obtain additional funding for related projects, and make this a permanent position.

Subawardee partners include:

- * Environmental Transformation Movement of Flint
- * Flint River Watershed Coalition
- * Michigan United
- * Crim Fitness Foundation
- * North Flint Neighborhood Action Council

Section IV: FINANCIAL IMPLICATIONS:

The FY25 budget will increase by \$1,000,000 for Fund 296 Department 704.750, with grant code FEPA-EVG2G24, with the ability to roll over any remaining funds to subsequent fiscal years, until the end of the grant period on May 31, 2027.

BUDGETED EXPENDITURE? YES NO **IF NO, PLEASE EXPLAIN:** N/A

Account Number	Account Name	Amount
296-704.750-702.010	WAGES - FULL-TIME (NON-EXEMPT)	\$214,375
296-704.750-702.020	SALARIED EMPLOYEE (EXEMPT)	\$13,625
296-704.750-706.000	HOLIDAY PAY	\$5,412
296-704.750-710.100	UNEMPLOYMENT COMPENSATION (SUTA)	\$3,675
296-704.750-710.200	FICA (SOCIAL SECURITY)	\$6,635
296-704.750-710.300	MEDICARE	\$3,901
296-704.750-713.000	WORKERS COMPENSATION	\$886
296-704.750-714.300	EMPLOYER HEALTH CARE SAVINGS PLAN (HCSP)	\$5,922
296-704.750-716.100	MERS HYBRID DEFINED CONTRIBUTION PENSION	\$9,607
296-704.750-717.100	MERS HYBRID DEFINED BENEFIT PENSION	\$14,316
296-704.750-718.010	HEALTH INSURANCE PREMIUMS	\$33,531
296-704.750-718.300	LIFE INSURANCE	\$986
296-704.750-718.400	OPTICAL INSURANCE	\$754
296-704.750-718.500	DENTAL INSURANCE	\$1,823

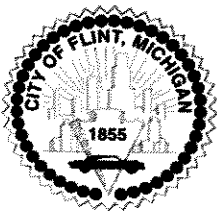

CITY OF FLINT STAFF REVIEW FORM

Revised July 2, 2024

296-704.750-719.100	ACCRUED ABSENCES	\$2,280
296-704.750-801.000	PROFESSIONAL SERVICES	\$540,000
296-704.750-802.000	CONTRACTUAL SERVICES	\$90,000
296-704.750-969.100	INDIRECT COST ALLOCATION	\$52,272
	Total:	\$1,000,000

PRE-ENCUMBERED? YES NO REQUISITION NO:

ACCOUNTING APPROVAL: Phillip Moore
Phillip Moore (Jul 9, 2024 16:01 EDT) Date: 07/09/2024

WILL YOUR DEPARTMENT NEED A CONTRACT? YES NO

Contracts for subawardees will be drafted using an EPA template, be revised through our legal department and signed by subawardees, according to the budget detail in the grant. Any other contractual services will be sought out and paid for through our standard financial procedures.

WHEN APPLICABLE, IF MORE THAN ONE (1) YEAR, PLEASE ESTIMATE TOTAL AMOUNT FOR EACH BUDGET YEAR: *(This will depend on the term of the bid proposal)*

BUDGET YEAR 1 \$

BUDGET YEAR 2

BUDGET YEAR 3

OTHER IMPLICATIONS *(i.e., collective bargaining)*: N/A

STAFF RECOMMENDATION: *(PLEASE SELECT)*: APPROVED NOT APPROVED

DEPARTMENT HEAD SIGNATURE:

Faith Groesbeck
Faith Groesbeck (Jul 9, 2024 15:36 EDT)

(Faith Groesbeck, Public Health Manager)



RESOLUTION NO.: 240291

PRESENTED: 7-17-2024

ADOPTED: _____

PROPOSAL #24000551

BY THE CITY ADMINISTRATOR:

RESOLUTION TO L.A. CONSTRUCTION FOR THE AVON PUMP STATION DEMOLITION
(CSWRF PHASE IV)

WHEREAS, The Division of Purchases & Supplies solicited proposals for the construction projects for Phase IV of the Michigan State Revolving Fund Loan Project Plan as requested by the Department of Public Works, Water Pollution Control. Council Resolution 190188.1, adopted on June 24, 2019, approved the Publicly Owned Treatment Works, DPW-WPC Improvements SRF Project Plan. For The Demolition of the Avon Pump Station, L.A. Construction Corporation, Flint, MI was the lowest responsive bidder for his proposal with a bid of \$2,049,602.30.

WHEREAS, The Avon Street Pump Station was built to redirect high sewage flows from the 3rd Ave. Interceptor to the tunnel interceptor, but subsequent modifications have rendered it now inoperable. Demoing this structure along with the connecting equipment, wiring and piping will result in a grassy area that matches surrounding grade.

Funding is to come from the following account(s):

Account Number	Account Name/ Grant Code	Amount
590-550.441-802.085	Avon Pump Station Const.	\$2,172,578.42
	FY2025 TOTAL	\$2,172,578.42

IT IS RESOLVED, that the Proper City Officials are hereby authorized to enter into a contract with L.A. Construction Corporation for the Avon Pump Station Demolition project for FY25 (07/01/24-06/30/25) in an amount not-to-exceed \$2,172,578.42 (which includes a 6% contingency of \$122,976.12), contingent upon successful financial arrangements with the SRF Program.

APPROVED AS TO FORM:

William Kim (Jul 5, 2024 08:01 EDT)

William Kim, City Attorney

APPROVED AS TO FINANCE:

Phillip Moore (Jul 5, 2024 07:39 EDT)

Phillip Moore, Chief Financial Officer

FOR THE CITY OF FLINT:

CLYDE D EDWARDS / A0243
CLYDE D EDWARDS / A0243 (Jul 8, 2024 11:37 EDT)

Clyde Edwards, City Administrator

APPROVED BY CITY COUNCIL:

City Council

APPROVED AS TO PURCHASING:



Lauren Rowley, Purchasing Manager



CITY OF FLINT STAFF REVIEW FORM

Revised July 2, 2024

TODAY'S DATE: July 2, 2024

BID/PROPOSAL: 24000551

AGENDA ITEM TITLE: Avon Pump Station Demolition – CWSRF Phase IV

PREPARED BY: Jeanette M. Best
WPC/DPW Manager

VENDOR NAME: L.A. Construction Corporation

Section I: BACKGROUND/SUMMARY OF PROPOSED ACTION:

The WPC Avon Street Pump Station was built to redirect high sewage flows from the 3rd Avenue interceptor to the tunnel interceptor. However subsequent modifications to the sewer system rendered it inoperable. This project will demolish the three (3) existing screw pumps, including connected ancillary equipment, wiring, piping and other appurtenances from within the Pump Station building and exterior wet well. Work includes the removal of the wet well structure to 18 inches below existing grade, removing gates, piping, and wiring from within the wet well, as well as bulk heading opening into and out of the wet well. The remaining wet well structure will then be backfilled with compacted fill material, and a 42-inch bypass sewer will be constructed, followed by the placement of topsoil and seed, resulting in a grassy area that matches surrounding grade.

I recommend that the lowest qualified bidder, L.A. Construction Corporation, be awarded the bid in the amount of \$2,049,602.30 + 6% (\$122,976.12) contingency = \$2,172,578.42 for the WPC Avon Pump Station Demolition.

Section II. PREVIOUS ALLOCATIONS (INCLUDE ALL ACCOUNTS USED FOR THIS PURPOSE)/ PROVIDE RESOLUTION OR CONTRACT INFORMATION THAT APPLIES

\$2,803,052.42 Saginaw St. Water Main Replacement. Wade Trim was the Engineering Firm for this project and the Senior Project Manager's comments are as follows:

The lowest responsive bid [for the Avon Demo Project] was from LA Construction Corporation (LA) with a base proposal total of \$2,049,602.30. LA has completed a number of projects throughout the City of Flint and is currently wrapping up the Saginaw Street Improvements project. Based on the work they have done to date and our knowledge of their work for the City, we have no objections to awarding them this project.

Given this, Wade Trim recommends that the City award the Avon Pumping Station Demolition project to LA for a total price of \$2,049,602.30. If you have any questions regarding this recommendation, please contact us.

Very truly yours,
Wade Trim, Inc.
Tiffany L. Harrison, PE
Senior Project Manager



CITY OF FLINT STAFF REVIEW FORM

Revised July 2, 2024

Section III. POSSIBLE BENEFIT TO THE CITY OF FLINT (RESIDENTS AND/OR CITY OPERATIONS) INCLUDE PARTNERSHIPS AND COLLABORATIONS:

The demolition of this unusable pumping station will correct and rehabilitate the sewer at this location and it will remove a public nuisance and safety hazard.

Section IV: FINANCIAL IMPLICATIONS:

This project is funded by the 2024 CWSRF program.

BUDGETED EXPENDITURE? YES NO IF NO, PLEASE EXPLAIN:

Dept.	Name of Account	Account Number	Grant Code	Amount
DPW/WPC	Avon PS Construction	590-550.441-802.085		\$2,172,578.42
FY24 GRAND TOTAL				\$2,172,578.42

PRE-ENCUMBERED? YES NO REQUISITION NO: 250008987

This encumbrance is contingent upon final approval from MI-EGLE for this CWSRF project. Once approved the funds will be made available. EGLE requires an approved resolution for the project prior to final approval.

ACCOUNTING APPROVAL: *[Signature]* Date: 7/3/24

WILL YOUR DEPARTMENT NEED A CONTRACT? YES NO

WHEN APPLICABLE, IF MORE THAN ONE (1) YEAR, PLEASE ESTIMATE TOTAL AMOUNT FOR EACH BUDGET YEAR: (This will depend on the term of the bid proposal)

- BUDGET YEAR 1 \$
- BUDGET YEAR 2
- BUDGET YEAR 3

OTHER IMPLICATIONS (i.e., collective bargaining):

STAFF RECOMMENDATION: (PLEASE SELECT): APPROVED NOT APPROVED

DEPARTMENT HEAD SIGNATURE: *[Signature]*
(Jeanette M. Best, WPC/DPW Manager)



SEALED PROPOSALS RECEIVED IN THE DIVISION OF PURCHASES & SUPPLIES

Avon Pump Station Demolition

Proposal #24000551

Approximate Annual Quantities – Not Guaranteed

Furnish as requested for the period 7/1/24 – 6/30/25

**Bidder #1: Zito Construction Company
Grand Blanc, MI.**

Total Contract Price: \$4,480,000.00

**Bidder #1: L.A. Construction Corporation
Flint, MI.**

Total Contract Price: \$2,049,602.30

****Both contractors have satisfied the minimum Purchasing guidelines by attending the mandatory pre-bid meeting, sending 1 electronic bid and 2 hard copies.**

A SPECIAL NOTE FROM THE PURCHASING DIVISION

Bid results posted are before evaluation team review and award recommendation.

**SECTION 00 42 43
PROPOSAL**

City of Flint - Water Pollution Control Facility, G-4652 Beecher Road, Flint, Michigan 48532

Project: WPCF Avon Pumping Station Demolition

BIDDER INFORMATION

Bidder Name: L. A. CONSTRUCTION CORPORATION

By (Printed Name): AARON C. ADKINS, VICE PRESIDENT

Signature: _____

Address: 3453 N. LINDEN RD., FLINT, MI 48504

Phone No: 810-659-7565

Email: laconstructioncorporation@gmail.com

The Bidder proposes and agrees, if their Bid is accepted, to enter into an Agreement with the City of Flint in the form included in the Contract Documents to complete all Work as specified or indicated in the Contract Documents for the Contract Price and within the Contract Time indicated in the Agreement, and in accordance with the Contract Documents.

In submitting their Bid, Bidder represents, as more fully set forth in the Agreement, that:

1. Bidder has examined copies of all Contract Documents, (consisting of Plans dated 05-22-2024 and Project Manual dated 05-22-2024) which he understands and accepts as sufficient for the purpose, including any and all Addenda officially issued, the receipt of which has been acknowledged.
 - A. Addendum 1 Acknowledged by: AARON C. ADKINS Date: 06/17/2024
 - B. Addendum _____ Acknowledged by: _____ Date: _____
 - C. Addendum _____ Acknowledged by: _____ Date: _____
2. Bidder has examined the surface and subsurface conditions where the Work is to be performed, the legal requirements and local conditions affecting cost, progress, furnishing or performance of the Work, and has made such independent investigations as Bidder deems necessary.
3. Their Bid is genuine and not made in the interest of or on behalf of any undisclosed person, firm or corporation and is not submitted in conformity with any Agreement or rules of any group, association, organization or corporation; Bidder has not directly or indirectly induced or solicited any other Bidder to submit a false or sham Bid; Bidder has not solicited or induced any person, firm or a corporation to refrain from bidding; and Bidder has not sought by collusion to obtain for himself any advantage over any other Bidder or over the Owner.
4. The Bidder agrees to complete the Work, in accordance with the Contract Documents, for the following Contract Price:

Item	Description	Quantity	Unit	Unit Price	Amount
1	Demolition of Screw Pumps, Ancillary Equipment and Appurtenances	1	LSUM	\$ <u>135,348.00</u>	\$ <u>135,348.00</u>
2	Demolition, Backfill & Restoration of Wet Well	1	LSUM	\$ <u>292,829.41</u>	\$ <u>292,829.41</u>
3	Construct 42-Inch Bypass Sewer	1	LSUM	\$ <u>1,621,424.89</u>	\$ <u>1,621,424.89</u>

Total Contract Price (Items 1 through 3)

\$2,049,602.30 TWO MILLION FORTY NINE THOUSAND SIX HUNDRED TWO DOLLARS AND 30 CENTS

5. The Bidder by submitting a Bid, thereby certifies that Bidder or a qualified designated person in Bidder's employ has examined the Contract Documents provided by the Owner for bidding purposes. Further, they certify that Bidder or Bidder's qualified employee has reviewed the Bidder's proposed construction methods and finds them compatible with the conditions which Bidder anticipates from the information provided for Bidding.
6. The Bidder by submitting a Bid agrees to complete the Work under any job circumstances or field conditions present and/or ascertainable prior to bidding. In addition, Bidder agrees to complete the Work under whatever conditions Bidder may create by Bidder's own sequence of construction, construction methods, or other conditions he may create, at no additional cost to the Owner.
7. The Bidder by submitting a Bid, declares that Bidder has familiarized them self with the location of the proposed Work and the conditions under which it must be constructed. Also, Bidder has carefully examined the Plans, the Specifications, and the Contract Documents, which Bidder understands and accepts as sufficient for the purpose and agrees that Bidder will Contract with the Owner to furnish all labor, material, tools, and equipment necessary to do all Work specified and prescribed for the completion of the Project.
8. The Bidder will provide a bid bond, in the amount of at least five (5) percent of the amount Bid, drawn payable to City of Flint as security for the proper execution of the Agreement.
9. The Bidder by submitting a Bid agrees that if awarded Contract, to sign the Agreement and submit satisfactory bonds and certificates of insurance coverage and other evidence of insurance required by the Contract Documents within 15 days after the date of Owner's Notice of Award.
10. The Bidder by submitting a Bid agrees that time is of the essence and, if awarded Contract, that the Work will be Completed on or before the dates/days as specified in the Agreement.
11. Liquidated damages, as specified in the General Conditions, Supplementary Conditions and Agreement, shall also apply to the Substantial Completion date.
12. Engineering and inspection costs incurred after the final completion date shall be paid by the Contractor to the Owner as specified in the Conditions of the Contract and Agreement.
13. Proposals may not be withdrawn for a period of 90 days after bid opening.
14. The following documents are made a condition of this Proposal:
 - A. Required Bid Security
 - B. Legal Status of Bidder
 - C. Non-Collusion Affidavit

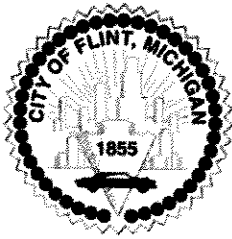

RESOLUTION NO.:

240292

PRESENTED:

7-17-2024

ADOPTED:

PROPOSAL #24000550

BY THE CITY ADMINISTRATOR:

RESOLUTION TO J. RANCK ELECTRIC, INC. FOR ELECTRICAL DISTRIBUTION IMPROVEMENTS-TRANSFORMERS (CSWRF PHASE IV)

WHEREAS, The Division of Purchases & Supplies solicited proposals for the construction projects for Phase IV of the Michigan State Revolving Fund Loan Project Plan as requested by the Department of Public Works, Water Pollution Control. Council Resolution 190188.1, adopted on June 24, 2019, approved the Publicly Owned Treatment Works, DPW-WPC Improvements SRF Project Plan. For Electrical Distribution Improvements-Transformers, J. Ranck Electric, Inc., Mt. Pleasant, MI was the lowest responsive bidder for his proposal with a bid of \$4,451,225.00.

WHEREAS, The WPC has multiple electrical transformers located on site and at the 3rd Avenue Pumping Station. They have exceeded their useful life and need improvements to avoid potential failure and assure reliability for WPC operation locations.

Funding is to come from the following account(s):

Account Number	Account Name/ Grant Code	Amount
590-550.441-802.086	Electrical Dist. Imp. Construction	\$4,718,269.00
	FY2025 TOTAL	\$4,718,269.00

IT IS RESOLVED, that the Proper City Officials are hereby authorized to enter into a contract with J. Ranck Electric Inc. for Electrical Distribution Improvements-Tranformers Project for FY25 (07/01/24-06/30/25) in an amount not-to-exceed \$4,718,269.00 (which includes a 6% contingency of \$267,044.00), contingent upon successful financial arrangements with the SRF Program.

APPROVED AS TO FORM:

William Kim (Jul 5, 2024 08:02 EDT)

William Kim, City Attorney

APPROVED AS TO FINANCE:

Phillip Moore (Jul 5, 2024 07:38 EDT)

Phillip Moore, Chief Financial Officer

FOR THE CITY OF FLINT:



CLYDE D EDWARDS / A0244
CLYDE D EDWARDS / A0244 (Jul 8, 2024 11:37 EDT)

Clyde Edwards, City Administrator

APPROVED BY CITY COUNCIL:

City Council

APPROVED AS TO PURCHASING:



Lauren Rowley, Purchasing Manager

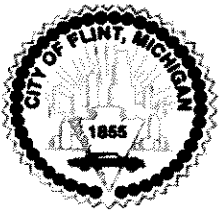

CITY OF FLINT STAFF REVIEW FORM

Revised July 2, 2024

TODAY'S DATE: July 2, 2024

BID/PROPOSAL: 24000550

AGENDA ITEM TITLE: WPC Electrical Distribution Improvements – Transformers, CWSRF Phase IV

PREPARED BY: Jeanette M. Best
WPC/DPW Manager

VENDOR NAME: J. Ranck Electric, Inc.

Section I: BACKGROUND/SUMMARY OF PROPOSED ACTION:

The WPC has multiple electrical transformers located on site and at the Third Avenue Pumping Station. The most recent installation of the transformers was 50 years ago. Some are even older. They have exceeded their useful life and could fail at any time. This project includes the replacement of the following transformers a) Sludge Thickener b) Oil Barn Transformer c) Incinerator Complex Transformers (2) d) Northwest Pump Station Transformers (2) e) Digester Transformer f) East Pumping Station Transformers (2) g) Third Avenue Pumping Station Transformers (2). It also includes updating of electrical coordination study, short circuit and arc-flash analysis and replaces the existing Third Ave. Pumping Station primary distribution transformers.

I recommend that the lowest qualified bidder, J. Ranck Electric, Inc. be awarded the bid in the amount of \$4,451,225.00 + 6% (\$267,044) contingency = \$4,718,269.00 for the WPC Electrical Distribution Improvements – Transformers.

Section II. PREVIOUS ALLOCATIONS (INCLUDE ALL ACCOUNTS USED FOR THIS PURPOSE)/ PROVIDE RESOLUTION OR CONTRACT INFORMATION THAT APPLIES

\$14,546,563.00 CWSRF Phase 3 Electrical Distribution Improvements, Resolution 230245 adopted 7-31-2023. WPCF is currently working with J. Ranck. Their work has been satisfactory. They are issuing submittals for specified equipment but have not yet started physical installation of the equipment. Electrical equipment has an extremely long lead time and can only be ordered after the submittals are approved by the engineer.

Section III. POSSIBLE BENEFIT TO THE CITY OF FLINT (RESIDENTS AND/OR CITY OPERATIONS) INCLUDE PARTNERSHIPS AND COLLABORATIONS:

The replacement of the very old transformers will assure reliability.

Section IV: FINANCIAL IMPLICATIONS:

This project is funded by the 2024 CWSRF program.

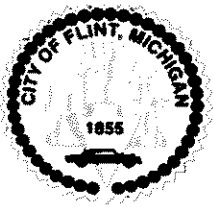

CITY OF FLINT STAFF REVIEW FORM

Revised July 2, 2024

BUDGETED EXPENDITURE? YES NO IF NO, PLEASE EXPLAIN:

Dept.	Name of Account	Account Number	Grant Code	Amount
DPW/WPC	Electrical Dist Imp Construction	5590-550.441-802.086		\$4,718,269.00
		FY25 GRAND TOTAL		\$4,718,269.00

PRE-ENCUMBERED? YES NO REQUISITION NO: 250008989

This encumbrance is contingent upon final approval from MI-EGLE for this CWSRF project. Once approved the funds will be made available. EGLE requires an approved resolution for the project prior to final approval.

ACCOUNTING APPROVAL: *H. Wallace* Date: 07/03/2024

WILL YOUR DEPARTMENT NEED A CONTRACT? YES NO

WHEN APPLICABLE, IF MORE THAN ONE (1) YEAR, PLEASE ESTIMATE TOTAL AMOUNT FOR EACH BUDGET YEAR: (This will depend on the term of the bid proposal)

BUDGET YEAR 1 \$

BUDGET YEAR 2

BUDGET YEAR 3

OTHER IMPLICATIONS (i.e., collective bargaining):

STAFF RECOMMENDATION: (PLEASE SELECT): APPROVED NOT APPROVED

DEPARTMENT HEAD SIGNATURE: *Jeanette M. Best*
(Jeanette M. Best, WPC/DPW Manager)



SEALED PROPOSALS RECEIVED IN THE DIVISION OF PURCHASES & SUPPLIES
Electrical Distribution Improvements - Transformers
Proposal #24000550
Approximate Annual Quantities – Not Guaranteed
Furnish as requested for the period 7/1/24 – 6/30/25

Bidder #1: Halligan Electric, Inc.
Davison, MI.

Based Bid: \$5,822,776.00

Bidder #2: Newkirk Electric Associates, Inc.
Flint, MI.

Based Bid: \$6,380,000.00

Bidder #3: Superior Electric Great Lakes Company
Troy, MI.

Based Bid: \$6,964,225.00

Bidder #4: J. Ranck Electric, Inc.
Mt. Pleasant, MI.

Based Bid: \$4,451,225.00

****PLEASE NOTE THAT J.RANCK HAS TIMELY SUBMITTED THEIR BID AND WAS READ PUBLICLY
AT 3:15PM EST.**

****All contractors have attended the mandatory pre-bid meeting. Superior Electric only
submitted one hard copy.**

A SPECIAL NOTE FROM THE PURCHASING DIVISION

Bid results posted are before evaluation team review and award recommendation.

SECTION 00400 - BID FORM

City of Flint
Water Pollution Control
Electrical Distribution Improvements - Transformers

Contract 200-156238-23001

THIS BID IS SUBMITTED TO:

City of Flint – Finance Department Division of Purchase and Supplies
Owner
1101 S. Saginaw St., Room 203, 2nd Floor
Address
Flint, MI 48502
City, State, Zip

- 1.01 The undersigned Bidder proposes and agrees, if this Bid is accepted, to enter into an Agreement with OWNER in the form included in the Bidding Documents to perform all Work as specified or indicated in the Bidding Documents for the prices and within the times indicated in this Bid and in accordance with the other terms and conditions of the Bidding Documents.
- 2.01 Bidder accepts all of the terms and conditions of the Advertisement or Invitation to Bid and Instructions to Bidders, including without limitation those dealing with the disposition of Bid security. The Bid will remain subject to acceptance for 90 days after the Bid opening, or for such longer period of time that Bidder may agree to in writing upon request of OWNER.
- 3.01 In submitting this Bid, Bidder represents, as set forth in the Agreement, that:
- A. Bidder has examined and carefully studied the Bidding Documents, the other related data identified in the Bidding Documents, and the following Addenda, receipt of all which is hereby acknowledged.

<u>Addendum No.</u>	<u>Addendum Date</u>
<u>1</u>	<u>June 3, 2024</u>
<u>2</u>	<u>June 18, 2024</u>
_____	_____

- B. Bidder has visited the Site and become familiar with and is satisfied as to the general, local, and Site conditions that may affect cost, progress, and performance of the Work.
- C. Bidder is familiar with and is satisfied as to all Federal, State, and local Laws and Regulations that may affect cost, progress, and performance of the Work.

- D. Bidder has carefully studied all:
1. Reports of explorations and tests of subsurface conditions at or contiguous to the Site and all drawings of physical conditions in or relating to existing surface or subsurface structures at or contiguous to the Site (except Underground Facilities) which have been identified in the Supplementary Conditions as provided in Paragraph 4.02 of the General Conditions, and
 2. Reports and drawings of a Hazardous Environmental Condition, if any, which has been identified in the Supplementary Conditions as provided in Paragraph 4.06 of the General Conditions.
- E. Bidder has obtained and carefully studied (or assumes responsibility for having done so) all additional or supplementary examinations, investigations, explorations, tests, studies and data concerning conditions (surface, subsurface and Underground Facilities) at or contiguous to the Site which may affect cost, progress, or performance of the Work or which relate to any aspect of the means, methods, techniques, sequences, and procedures of construction to be employed by Bidder, including applying the specific means, methods, techniques, sequences, and procedures of construction expressly required by the Bidding Documents to be employed by Bidder, and safety precautions and programs incident thereto.
- F. Bidder does not consider that any further examinations, investigations, explorations, tests, studies, or data are necessary for the determination of this Bid for performance of the Work at the price(s) bid and within the times and in accordance with the other terms and conditions of the Bidding Documents.
- G. Bidder has correlated the information known to Bidder, information and observations obtained from visits to the Site, reports and drawings identified in the Bidding Documents, and all additional examinations, investigations, explorations, tests, studies, and data with the Bidding Documents.
- H. Bidder has given ENGINEER written notice of all conflicts, errors, ambiguities, or discrepancies that Bidder has discovered in the Bidding Documents, and the written resolution thereof by ENGINEER is acceptable to Bidder.
- I. The Bidding Documents are generally sufficient to indicate and convey understanding of all terms and conditions for the performance of the Work for which this Bid is submitted.
- J. In preparation of this Bid, Bidder acknowledges that it will not discriminate against any employee or applicant for employment with respect to hire, tenure, conditions, or privileges of employment, or a matter directly or indirectly related to employment, because of race, color, religion, national origin, age, sex, height, weight, marital status, or a disability that can be reasonable accommodated. OWNER will require this covenant be placed in the Contract with any subcontractor employed in the performance of this Contract.
- K. All claims and disputes arising from related Work at Site by other contractors shall be settled in accordance with Paragraph 7.03 of the Supplementary Conditions.
- 4.01 Bidder further represents that this Bid is genuine and not made in the interest of or on behalf of any undisclosed individual or entity and is not submitted in conformity with any agreement or rules of any group, association, organization or corporation; Bidder has not directly or indirectly induced or solicited any other Bidder to submit a false or sham Bid; Bidder has not solicited or induced any individual or entity to refrain from bidding; and Bidder has not sought by collusion to obtain for itself any advantage over any other Bidder or over OWNER.

5.01 Bidder will complete the Work in accordance with the Contract Documents for the following price(s):

A. BID PRICE FOR ALL WORK Four Million Four Hundred Fifty-one Thousand Two Hundred Twenty-five Dollars (\$4,451,225.00)
(use words) (figures)

B. All specific allowances are included in the price(s) set forth above and have been computed in accordance with Paragraph 11.02 of the General Conditions.

1. Included in the Bid Price is a Lump Sum Allowance for Consumers Energy services related to turning off each source of power in the amount of \$50,000.

6.01 CONTRACTOR shall list subcontractors proposed for the following Work.

<u>Discipline</u>	<u>Subcontractor Name</u>
Demolition	N/A
Concrete	N/A
Concrete Repair	N/A
Painting	N/A
Process Piping and Equipment	N/A
HVAC	N/A
Electrical	J. Ranck Electric, Inc.
Instrumentation	N/A
Other	N/A

7.01 Bidder agrees that the Work will be substantially completed and completed and ready for final payment in accordance with Paragraph 14.07.B of the General Conditions on or before the dates or within the number of calendar days indicated in the Agreement.

8.01 Bidder accepts the provisions of the Agreement as to liquidated damages in the event of failure to complete the Work within the times specified above, which shall be stated in the Agreement.

9.01 The following documents are attached to and made a condition of this Bid:

- A. Evidence of Bidder's qualification to do business in the state where the Project is located or covenant to obtain such qualification prior to award of the Contract; and
- B. Required Bid Security in the form of a certified check, bank check, or a Bid Bond; and

10.01 The terms used in this Bid with initial capital letters have the meanings indicated in the Instructions to Bidders, the General Conditions, and the Supplementary Conditions.

SUBMITTED on June 26, 2024.

State Contractor License No. 6104713 (If applicable)

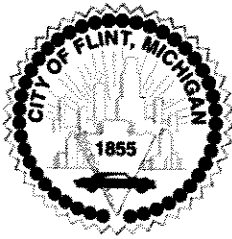

RESOLUTION NO.: 240293

PRESENTED: 7-17-2024

ADOPTED: _____

PROPOSAL #24000549

BY THE CITY ADMINISTRATOR:

RESOLUTION TO RIC-MAN CONSTRUCTION FOR 3RD AVE. PUMP STATION FORCE MAIN REHABILITATION (CSWRF PHASE VI)

WHEREAS, The Division of Purchases & Supplies solicited proposals for the construction projects for Phase IV of the Michigan State Revolving Fund Loan Project Plan as requested by the Department of Public Works, Water Pollution Control. Council Resolution 190188.1, adopted on June 24, 2019, approved the Publicly Owned Treatment Works, DPW-WPC Improvements SRF Project Plan. For the 3rd Ave. Pump Station Force Main Rehabilitation project, Ric-Man Construction, Inc., Sterling Heights, Michigan was the sole responsive bidder for this proposal with a base bid of \$54,994,484.00.

WHEREAS, The 3rd Avenue Pumping Station (TAPS) rehabilitation is necessary to ensure continuous flow from TAPS to the WPC Facility. The project will prevent basement backups and pipe failure. This project will also include Final Testing of the force mail system upgrades upon construction completion.

Funding is to come from the following account(s):

Account Number	Account Name/ Grant Code	Amount
590-550.441-802.087	3 rd Ave. FM Imp. Construction	\$54,994,484.00
	FY2025 TOTAL	\$54,994,484.00

IT IS RESOLVED, that the Proper City Officials are hereby authorized to enter into a contract with Ric-Man Construction, Inc. for the 3rd Avenue Force Main Rehabilitation Project for FY25 (07/01/24-06/30/25) in an amount not-to-exceed \$54,994.484 (which includes a 6% contingency), contingent upon successful financial arrangements with the SRF Program.

APPROVED AS TO FORM:

William Kim
William Kim (Jul 9, 2024 15:28 EDT)

William Kim, City Attorney

APPROVED AS TO FINANCE:

Phillip Moore
Phillip Moore (Jul 9, 2024 15:19 EDT)

Phillip Moore, Chief Financial Officer

FOR THE CITY OF FLINT:

CLYDE D EDWARDS / A0251
CLYDE D EDWARDS / A0251 (Jul 9, 2024 18:40 EDT)

Clyde Edwards, City Administrator

APPROVED BY CITY COUNCIL:

City Council

APPROVED AS TO PURCHASING:

Lauren Rowley

Lauren Rowley, Purchasing Manager

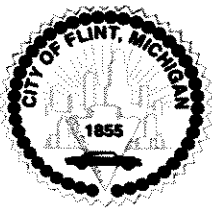

CITY OF FLINT STAFF REVIEW FORM

Revised July 2, 2024

TODAY'S DATE: July 2, 2024

BID/PROPOSAL: 24000549

AGENDA ITEM TITLE: 3rd Avenue Pump Station Force Main Rehab – CWSRF Phase IV

PREPARED BY: Jeanette M. Best
WPC/DPW Manager

VENDOR NAME: Ric-Man Construction, Inc.

Section I: BACKGROUND/SUMMARY OF PROPOSED ACTION:

The WPC 3rd Avenue Pumping Station (TAPS) was built in 1925 and the WPCF was constructed between 1925-1927. Force mains were constructed between the 3rd Avenue Pumping Station and the WPCF in 1925 and a second one in 1974. These force mains are well beyond their useful life and need to be rehabilitated. Phase 1 of this project will provide flow isolation for the existing parallel 50-inch and 72-inch forcemains at the upstream Third Avenue Pump Station (TAPS) and the downstream Water Pollution Control Facility (WPCF), including rehab work on the concrete trestle supports at two aerial crossings for the existing 50-inch and 72-inch forcemains. Phase 2 includes pipe lining rehabilitation of the existing 72-inch PCCP force main between TAPS and WPCF which is listed in several segments. It is the intent of the project to award the entire Phase 1 and Phase 2A and 2B Base Bid work. This will also include Final Testing of the force main system upgrades upon construction completion.

I recommend that the sole qualified bidder, Ric-Man Construction, Inc., be awarded the bid in the amount of \$54,994,484.00 (the 6% contingency is included) for WPC 3rd Avenue Pump Station Force Main Rehabilitation.

Section II. PREVIOUS ALLOCATIONS (INCLUDE ALL ACCOUNTS USED FOR THIS PURPOSE)/ PROVIDE RESOLUTION OR CONTRACT INFORMATION THAT APPLIES

\$0

Section III. POSSIBLE BENEFIT TO THE CITY OF FLINT (RESIDENTS AND/OR CITY OPERATIONS) INCLUDE PARTNERSHIPS AND COLLABORATIONS:

Rehabilitation of the TAPS force main will assure continuous flow from TAPS to the WPC. Isolation valves will allow the forcemains to be inspected and repaired should they need it avoiding pipe failures. It will also prevent basement back up and sewage discharges to the river when pipe maintenance is needed.

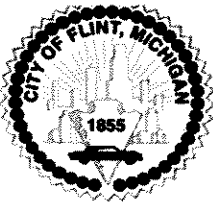

CITY OF FLINT STAFF REVIEW FORM

Revised July 2, 2024

Section IV: FINANCIAL IMPLICATIONS:

This project is funded by the 2024 CWSRF program.

BUDGETED EXPENDITURE? YES NO IF NO, PLEASE EXPLAIN:

Dept.	Name of Account	Account Number	Grant Code	Amount
DPW/WPC	3 rd Ave Force mains Imp Construction	590-550.441-802.087		\$54,994,484.00
FY2025 GRAND TOTAL				\$54,994,484.00

PRE-ENCUMBERED? YES NO REQUISITION NO: 250008990

This encumbrance is contingent upon final approval from MI-EGLE for this CWSRF project. Once approved the funds will be made available. EGLE requires an approved resolution for the project prior to final approval.

ACCOUNTING APPROVAL:  Date: 07/02/24

WILL YOUR DEPARTMENT NEED A CONTRACT? YES NO

WHEN APPLICABLE, IF MORE THAN ONE (1) YEAR, PLEASE ESTIMATE TOTAL AMOUNT FOR EACH BUDGET YEAR: (This will depend on the term of the bid proposal)

BUDGET YEAR 1 \$

BUDGET YEAR 2

BUDGET YEAR 3

OTHER IMPLICATIONS (i.e., collective bargaining):

STAFF RECOMMENDATION: (PLEASE SELECT): APPROVED NOT APPROVED

DEPARTMENT HEAD SIGNATURE: 
(Jeanette M. Best, WPC/DWP Manager)



SEALED PROPOSALS RECEIVED IN THE DIVISION OF PURCHASES & SUPPLIES
3rd Avenue Pump Station Rehab
Proposal #24000549
Approximate Annual Quantities – Not Guaranteed
Furnish as requested for the period 7/1/24 – 6/30/25

Bidder #1: Ric-Man Construction, Inc.
Sterling Heights, MI.

Base Bid: \$54,994,484.00

A SPECIAL NOTE FROM THE PURCHASING DIVISION

Bid results posted are before evaluation team review and award recommendation.

**SECTION 00 42 43
PROPOSAL**

Owner: City of Flint

Project: Third Avenue Pumping Station Forcemain Rehabilitation

Project Location: 2301 University Avenue, Flint MI 48504 MI

BIDDER INFORMATION

Bidder Name: RIC-MAN CONSTRUCTION, INC.

By (Printed Name): STEVEN MANCINI

Signature: [Signature]

Address: 4150 MAUND RD STERLING HEIGHTS, MI

Phone No: 586-739-5010

Email: SMANCINI@RIC-MAN.COM

The Bidder proposes and agrees, if their Bid is accepted, to enter into an Agreement with the City of Flint in the form included in the Contract Documents to complete all Work as specified or indicated in the Contract Documents for the Contract Price and within the Contract Time indicated in the Agreement, and in accordance with the Contract Documents.

In submitting their Bid, Bidder represents, as more fully set forth in the Agreement, that:

1. Bidder has examined copies of all Contract Documents (consisting of Plans dated Ready for Bidders date and Project Manual dated Ready for Bidders date) which Bidder understands and accepts as sufficient for the purpose, including any and all Addenda officially issued, the receipt of which has been acknowledged.

- A. Addendum 1 Acknowledged by: [Signature] Date: 6/19/24
- B. Addendum 2 Acknowledged by: [Signature] Date: 6/26/24
- C. Addendum _____ Acknowledged by: _____ Date: _____

- 2. Bidder has examined the surface and subsurface conditions where the Work is to be performed, the legal requirements and local conditions affecting cost, progress, furnishing or performance of the Work, and has made such independent investigations as Bidder deems necessary.
- 3. Their Bid is genuine and not made in the interest of or on behalf of any undisclosed person, firm or corporation and is not submitted in conformity with any Agreement or rules of any group, association, organization or corporation; Bidder has not directly or indirectly induced or solicited any other Bidder to submit a false or sham Bid; Bidder has not solicited or induced any person, firm or a corporation to refrain from bidding; and Bidder has not sought by collusion to obtain for himself any advantage over any other Bidder or over the Owner.
- 4. The Bidder agrees to complete the Work, in accordance with the Contract Documents, for the following Contract Price:

See Next Page for Base Bid

Addendum 02
Issued 06-24-2024

Base Bid:

Item	Description	Quantity	Unit	Unit Price	Amount
1	Mobilization	1	LSUM	\$ <u>1,000,000</u>	\$ <u>1,000,000</u>
2	Third Avenue Pumping Station (TAPS) Modifications for New Header Forcemain Valve Vaults and Piping	1	LSUM	\$ <u>18,655,000</u>	\$ <u>18,655,000</u>
3	Modifications at Water Pollution Control Facility (WPCF)	1	LSUM	\$ <u>7,900,000</u>	\$ <u>7,900,000</u>
4	Temporary Bypassing Pumping System at WPCF during Outlet Modifications	1	LSUM	\$ <u>2,750,000</u>	\$ <u>2,750,000</u>
5	Trestle Locations 1 and 2 Rehabilitation/Repairs	1	LSUM	\$ <u>639,484</u>	\$ <u>639,484</u>
6	Phase 2A 72-inch Forcemain Cleaning and Internal Inspection-TAPS to WPCF	1	LSUM	\$ <u>1,000,000</u>	\$ <u>1,000,000</u>
7	Phase 2B 72-inch Forcemain Rehabilitation from Sta 118 + 00 to 167 + 50 and Sta 2+48 to Sta 4 + 50	1	LSUM	\$ <u>18,700,000</u>	\$ <u>18,700,000</u>
8	Testing of Existing 50-inch and Rehabilitated 72-inch Forcemain	1	LSUM	\$ <u>255,000</u>	\$ <u>255,000</u>
9	Owner Controlled Contingency Allowance	1	LSUM		\$3,900,000
10	TAPS Utility Relocations for Work by Utility Companies	1	LSUM		\$175,000
11	SCADA Allowance	1	LSUM		\$20,000

Unit Price Breakdown for Item 5 - Trestle Locations 1 and 2 Rehabilitation/Repairs:

Item	Description	Quantity	Unit	Unit Price
5.1	Pressure Injection of Non-Weeping Crack Repair, Type 1	60	LFT	\$ <u>260</u>
5.2	Concrete Surface Repair, Type 2A	40	SFT	\$ <u>167</u>
5.3	Concrete Surface Repair, Type 2B	25	SFT	\$ <u>417</u>
5.4	Sawcut Form and Pour Repair, Type 3	1.5	CYD	\$ <u>4170</u>
5.5	Brick Repointing Repair, Type 4	25	LFT	\$ <u>200</u>
5.6	Protective Coating Repair, Type 5	6,800	SFT	\$ <u>17</u>
5.7	Guardrail Post Repair, Type 6	7	EA	\$ <u>840</u>
5.8	Replacement Steel Support Beams	1,450	LBS	\$ <u>45</u>
5.9	Blast and Recoat Steel Supports	3,160	SFT	\$ <u>61</u>
5.10	Grout Bag Closure Wall	225	CFT	\$ <u>154</u>
5.11	Flowable Fill Beneath Footings	22	CYD	\$ <u>2472</u>
5.12	Slide Rail System	1	EACH	\$ <u>110,000</u>
5.13	Site Restoration	1	LSUM	\$ <u>17,000</u>

Note: The Unit Price Breakdown for Item 5 (table above) should equate to the Unit Price (Lump Sum) entered into Item 5 in the Base Bid.

Addendum 02
Issued 06-24-2024

Additive Alternates:

Item	Description	Quantity	Unit	Unit Price	Amount
12	Phase 2C 72-inch Liner Sta 78+50 to Sta 118+00	1	LSUM	\$ <u>No Bid</u>	\$ <u>No Bid</u>
13	Phase 2D 72-inch Liner Sta 40+80 to Sta 78+50	1	LSUM	\$ <u>No Bid</u>	\$ <u>No Bid</u>
14	Phase 2E 72-inch Liner Sta 4+45 to Sta 40+80	1	LSUM	\$ <u>No Bid</u>	\$ <u>No Bid</u>

Bid Summary:

Base Bid Total for Phase 1, 2A and 2B (Items 1 through 11)

\$ 54,994,484

Base Bid + Additive Alternate Phase 2C (Items 1 through 12)

\$ No Bid

Base Bid + Additive Alternates Phase 2C and 2D (Items 1 through 13)

\$ No Bid

Base Bid + Additive Alternates Phase 2C, 2D and 2E (Items 1 through 14)

\$ No Bid

Bidder's Chosen Pipe Liner Material and Supplier:

STEEL - AMERICAN/THOMPSON/NORTHWEST Fred - Thompson

5. The Bidder by submitting a Bid, thereby certifies that Bidder or a qualified designated person in Bidder's employ has examined the Contract Documents provided by the Owner for bidding purposes. Further, they certify that Bidder or Bidder's qualified employee has reviewed the Bidder's proposed construction methods and finds them compatible with the conditions which Bidder anticipates from the information provided for Bidding.
6. The Bidder by submitting a Bid agrees to complete the Work under any job circumstances or field conditions present and/or ascertainable prior to bidding. In addition, Bidder agrees to complete the Work under whatever conditions Bidder may create by Bidder's own sequence of construction, construction methods, or other conditions he may create, at no additional cost to the Owner.
7. The Bidder by submitting a Bid, declares that Bidder has familiarized them self with the location of the proposed Work and the conditions under which it must be constructed. Also, Bidder has carefully examined the Plans, the Specifications, and the Contract Documents, which Bidder understands and accepts as sufficient for the purpose and agrees that Bidder will Contract with the Owner to furnish all labor, material, tools, and equipment necessary to do all Work specified and prescribed for the completion of the Project.
8. The Bidder will provide a bid bond, in the amount of at least **five (5)** percent of the amount Bid, drawn payable to City of Flint as security for the proper execution of the Agreement.

240295

RESOLUTION NO: _____

PRESENTED: _____

ADOPTED: _____

RESOLUTION APPROVING REALLOCATION OF ARPA FUNDS TO PROCEED WITH GRANTS FOR BLIGHT REMEDIATION FOR THE NEIGHBORHOOD ENGAGEMENT HUB BY OFFICE OF THE 2ND WARD FOR 2025

BY THE CITY COUNCIL:

The Councilperson in the 2nd Ward recommends reallocating \$10,000 of ARPA Funds (Ward Account), previously obligated for revenue replacement, to provide funding to the Neighborhood Engagement Hub to serve as a fiduciary to support summer lawn care maintenance of Landbank properties and Abandoned Private properties in the 2nd Ward.

Reallocated funds will be moved from #101-287.000-963.000 as follows:
Account #: 101-728.018-801.000 Description: Neighborhood Engagement Hub
Amount: \$10,000 (Ward Account).

IT IS RESOLVED, that the appropriate City officials are authorized to do all things necessary, including executing any necessary agreements, to appropriate funding from the funding source account #101-287.000-963.000 to the Neighborhood Engagement Hub in the Amount of \$10,000.

Based on review and validation of the appropriate fund use by the City's compliance firm, implementation of these funds will be consistent and compliant with US Department of Treasury requirements and previously approved authorizations.

APPROVED AS TO FORM:

APPROVED BY FLINT CITY COUNCIL:

William Kim, Chief Legal Officer



240302

RESOLUTION NO.: _____

PRESENTED: 7-17-2024

ADOPTED: _____

RESOLUTION APPROVING REALLOCATION OF ARPA FUNDS TO PROCEED WITH FUNDS GRANTS FOR YOUTH JOB TRAINING FOR ACTIVE BOYS IN CHRIST

BY THE CITY ADMINISTRATION:

In 2022 and 2023, the City of Flint received funds pursuant to the American Rescue Plan Act of 2021 (ARPA), which could be used by the City for specific and defined purposes. In 2023, the City of Flint obligated all of the ARPA funding received, of which approximately \$40 million was obligated as “revenue replacement;”

City Administration recommends reallocating \$146,750 of ARPA funds, previously obligated for revenue replacement, to provide funding to the Urban Renaissance Center to Reallocated funds will be moved from #101-000.000-385.287 as follows:

Account	Description	Amount
101-728.018-801.000	Active Boys in Christ	\$146,750

IT IS RESOLVED that the appropriate City officials are authorized to do all things necessary, including executing any necessary agreements, to appropriate funding from the funding source account #101-000.000-385.287 to Active Boys in Christ in the amount of \$146,750. Based on review and validation of the appropriate fund use by the City’s compliance firm, implementation of these funds will be consistent and compliant with US Department of Treasury requirements and previously approved authorizations.

For the City:

CLYDE D EDWARDS / A0259
CLYDE D EDWARDS / A0259 (Jul 17, 2024 13:21 EDT)
Clyde D. Edwards, City Administrator

For the City Council:

Approved as to Form:

William Kim
William Kim (Jul 17, 2024 10:30 EDT)
William Kim, City Attorney

Approved as to Finance:

Phillip Moore
Phillip Moore (Jul 17, 2024 10:37 EDT)
Phillip Moore, Chief Financial Officer

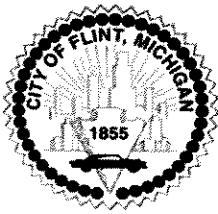

CITY OF FLINT STAFF REVIEW FORM

Revised July 2, 2024

TODAY'S DATE: 7/15/2024

BID/PROPOSAL# A0259

AGENDA ITEM TITLE: RESOLUTION APPROVING REALLOCATION OF ARPA FUNDS TO PROCEED WITH FUNDS GRANTS FOR YOUTH JOB TRAINING FOR ACTIVE BOYS IN CHRIST

PREPARED BY: Shelly Sparks-Green

VENDOR NAME: Active Boys in Christ

Section I: BACKGROUND/SUMMARY OF PROPOSED ACTION:

ABC Youth is a non-profit organization that offers boys and girls ages 7-17 free skilled trades training, focusing on electrical, plumbing, carpentry, and culinary arts, coupled with life skills sessions teaching several different components of character traits. Nearly 98% percent of our students come from economically disadvantaged backgrounds and we want to provide the space and culture of hope for kids and families who are labeled at-risk.

Youth engage in hands-on activities exploring carpentry, electrical, plumbing, window installation, siding, and roofing as they build and construct sheds and homes. The goal is to train and prepare students to advance their skills to become contracted by local skilled trades contractors, local unions, and trades agencies; thus, reducing violence, improving scholastic competence, job competency, and safe community engagement.

Section II. PREVIOUS ALLOCATIONS (INCLUDE ALL ACCOUNTS USED FOR THIS PURPOSE)/ PROVIDE RESOLUTION OR CONTRACT INFORMATION THAT APPLIES

Active Boys In Christ has received funds from ARPA in different categories.

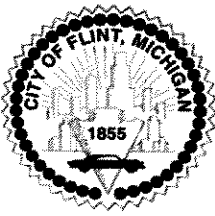

CITY OF FLINT STAFF REVIEW FORM

Revised July 2, 2024

Section III. POSSIBLE BENEFIT TO THE CITY OF FLINT (RESIDENTS AND/OR CITY OPERATIONS) INCLUDE PARTNERSHIPS AND COLLABORATIONS:

The program's focus on skilled trades training can also improve scholastic competence. Studies have shown that hands-on learning can help students to better understand academic concepts. Additionally, the sense of accomplishment that comes from completing a project can boost a student's confidence and motivation in school. By providing positive outlets and opportunities for at-risk youth, ABC Youth can also help to reduce violence in Flint.

Section IV: FINANCIAL IMPLICATIONS:

American Rescue Plan Act funds must be fully expended by 12/31/26.

BUDGETED EXPENDITURE? YES NO IF NO, PLEASE EXPLAIN:

Dept.	Name of Account	Account Number	Grant Code	Amount
Mayor's Office	Active Boys in Christ	101-728.018-801.000	Revenue Replacement	\$146,750
		FY24 GRAND TOTAL		\$146,750

PRE-ENCUMBERED? YES NO REQUISITION NO:

ACCOUNTING APPROVAL: Phillip Moore
Phillip Moore (Jul 17, 2024 10:37 EDT) Date: 07/17/2024

WILL YOUR DEPARTMENT NEED A CONTRACT? YES NO

WHEN APPLICABLE, IF MORE THAN ONE (1) YEAR, PLEASE ESTIMATE TOTAL AMOUNT FOR EACH BUDGET YEAR: *(This will depend on the term of the bid proposal)*



CITY OF FLINT STAFF REVIEW FORM

Revised July 2, 2024

BUDGET YEAR 1 \$

BUDGET YEAR 2

BUDGET YEAR 3

OTHER IMPLICATIONS (*i.e., collective bargaining*):

STAFF RECOMMENDATION: (PLEASE SELECT): APPROVED NOT APPROVED

DEPARTMENT HEAD SIGNATURE: 
Shelly Sparks-Green (Jul 17, 2024 13:19 EDT)
Shelly Sparks-Green , Chief Resilience Officer

240303

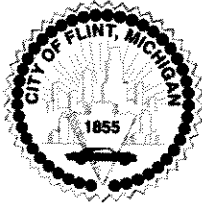

RESOLUTION NO.: _____

PRESENTED: 7-17-2024

ADOPTED: _____

BY THE CITY ADMINISTRATOR:

**RESOLUTION TO INA STORE, INC. FOR A CASE WHEEL LOADER
FOR THE STREET MAINTENANCE DIVISION**

WHEREAS, the Fleet Division has utilized Sourcewell cooperative contract #011723 for CNH Industrial for the purchase of a Case brand wheel loader for the Department of Public Works, Street Maintenance Division; and

To ensure adequate funding is available, a transfer from the Fleet (661) fund balance for \$217,641.59 is needed.

Account Code	Description	Amount
661.229.000-977.000	Equipment	\$217,641.59

IT IS RESOLVED, that appropriate City officials are authorized to amend the FY2025 by transfer of funds for \$217,641.59 from Fleet (661) fund balance; and

IT IS FURTHER RESOLVED, that the Purchasing Division is now authorized to issue a purchase order to INA Store, Inc. to purchase a Case brand wheel loader in an amount not to exceed \$217,641.59.

APPROVED AS TO FORM:

William Kim (Jul 16, 2024 13:14 EDT)

William Kim, City Attorney

APPROVED AS TO FINANCE:

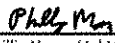
Phillip Moore (Jul 16, 2024 12:55 EDT)

Phillip Moore, Chief Financial Officer

FOR THE CITY OF FLINT:

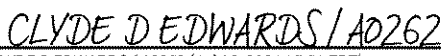
CLYDE D EDWARDS / A0262
CLYDE D EDWARDS / A0262 (Jul 16, 2024 15:51 EDT)

Clyde Edwards, City Administrator

APPROVED BY CITY COUNCIL:

City Council

APPROVED AS TO PURCHASING:



Lauren Rowley, Purchasing Manager



CITY OF FLINT STAFF REVIEW FORM

Revised July 2, 2024

TODAY'S DATE: 7/10/2024

BID/PROPOSAL#: N/A

AGENDA ITEM TITLE: Equipment Purchase for Street Maintenance

PREPARED BY: Marquita Blair, Fleet Administrator

VENDOR NAME: INA Store Inc Dealership (CNH Industrial Sourcewell contract)

Section I: BACKGROUND/SUMMARY OF PROPOSED ACTION:

Street Maintenance is requesting to purchase Equipment/Machinery: Wheel Loader (also referred to as a front or bucket loader) - Machine equipped with 2.5yd multipurpose 4NI bucket. A new unit will replace the expired John Deere leased unit 6091 (lease reference number 22-003953) needed for the Street Maintenance Division.

INA, Sourcewell contract #011723 City of Flint account # 80495, submitted a quote of \$217,641.19. The machine is scheduled for production on 1/08/2025.

Section II. PREVIOUS ALLOCATIONS (INCLUDE ALL ACCOUNTS USED FOR THIS PURPOSE)/ PROVIDE RESOLUTION OR CONTRACT INFORMATION THAT APPLIES

New equipment pricing based on Sourcewell Contract #011723 City of Flint Account # 80495. Replacing old unit 6091 - Deere - Fleet - Account 030-0063090-012 (661)

Section III. POSSIBLE BENEFIT TO THE CITY OF FLINT (RESIDENTS AND/OR CITY OPERATIONS) INCLUDE PARTNERSHIPS AND COLLABORATIONS:

Street Maintenance uses wheel loaders to load, carry, and transport material across a job site. The machinery can haul large amounts of fine materials such as sand to larger objects such as rock, concrete, and demolition debris. INA Store has been successful in providing the city with various pieces of equipment for DPW and blight division. This is a replacement piece of equipment needed for Streets Maintenance.

Section IV: FINANCIAL IMPLICATIONS:

It has been determined that purchasing the equipment will result in cost savings instead of leasing. To buy the equipment, the use of balance will be needed to complete the purchase.



CITY OF FLINT STAFF REVIEW FORM

Revised July 2, 2024

BUDGETED EXPENDITURE? YES X NO IF NO, PLEASE EXPLAIN: Use of Fleet Fund #661 fund balance is needed to complete the purchase.

Dept.	Name of Account	Account Number	Grant Code	Amount
Streets	Equipment	661.229.000-977.000	N/A	\$217,641.59
FY24 GRAND TOTAL				\$217,641.59

PRE-ENCUMBERED? YES X NO REQUISITION NO:

ACCOUNTING APPROVAL: V. Foster

WILL YOUR DEPARTMENT NEED A CONTRACT? YES NO

WHEN APPLICABLE, IF MORE THAN ONE (1) YEAR, PLEASE ESTIMATE TOTAL AMOUNT FOR EACH BUDGET YEAR: (This will depend on the term of the bid proposal)

BUDGET YEAR 1 \$

BUDGET YEAR 2

BUDGET YEAR 3

OTHER IMPLICATIONS (i.e., collective bargaining):

STAFF RECOMMENDATION: (PLEASE SELECT): **APPROVED** **NOT APPROVED**

DEPARTMENT HEAD SIGNATURE: Marquita Blair, Fleet Administrator
(Name, Title)



CUSTOMER INFORMATION:	
CITY OF FLINT - 810/766/7015	
1101 S SAGINAW ST	
FLINT, MICHIGAN 48502 USA	

DEALERSHIP	
THE INASTORE, INC.	
4770 ZELLE ROAD	
BRIDGEPORT, MI 48722 US	
989-777-1900	
Email	tim@theinastore.com
SALESPERSON:	Tim Brown - 9892391349

Retail Offer Number:	0001136107-1
----------------------	--------------

Retail Offer Valid to:	06/30/2024
------------------------	------------

Description:	City of Flint 621G
--------------	--------------------

UNITS OFFERED			
Unit # 1 621G2 ZBAR T4 FINAL LEC		List Price	290,530.00
Vehicle / Quote Number:	0019378334	Offered Price	217,641.59
Sales Order Number:	0087566427		
VIN/Serial #:			
Financed By	CNH Industrial Capital		
Rate Type	Low Rate		
Finance Program	N/A		

Total	\$217,641.59
--------------	---------------------

Down Payment	\$-0.00
---------------------	----------------

Total Offer Value	\$217,641.59
--------------------------	---------------------

Pricing based on Sourcewell contract #011723 City of Flint account # 80495. Machine equipped with 2.5yd multi purpose 4N1 bucket instead of 3.0yd GP bucket. Price includes delivery and training

Vehicle Configuration

Vehicle / Quote Number: 0019378334, 0087566427					
87736988	621G JRB ZBAR/XR COUPLER	8,220.00	734133	LED LIGHTS 4 FR 2 RE	
92147602	3.0 CU. YD. JRB COUPLER	12,360.00	782114	AM/FM BLUETOOTH STEREO	
	BUCKET			RADIO	
NORMAL	NORMAL OFFER		734141	HEATED AIR SEAT WITH	
				HEADREST	
ZL	ZL		782559	SOUND SUPPRESSION PACKAGE	
CASE	CASE		424225	5-SPEED TRANSMISSION	4,253.00
EH	EH		734115	XR LINKAGE	7,159.00
NAT4-L2	NAT4B-LE 78		734596	TRANSPORT PROTECTION	
STD12	STD12		782537	BUCKET PINS, NO BKT OR	
				COUPLER	
	Base price	255,745.00	424911	LOCKING HYDRAULIC FOR	
				COUPLER	
734117	NO GUARDING PACKAGE		482307	RETRIEVAL HITCH	
734138	NO TELEMATIC		734139	NO INTEGRATED PAYLOAD	
				SYSTEM	
424234	REAR VIEW CAMERA		482059	HEAVY COUNTERWEIGHT	
734146	QUICK PICK 2 - D W 1906		482027	SKID PLATE/TRANSMISSION	956.00
				GUARD	
734152	ENHANCED CAB COMFORT	932.00	782897	REAR FRAME SIDE COVERS	
734154	ENHANCED VISIBILITY BUNDLE	1,997.00	482105	ENGLISH LITERATURE	
734890	BU-621G T4B 734890		782122	LIMITED SLIP DIFFERENTIALS	
482585	COOLING SYSTEM W/REVERSING		9420538	20.5R25 L3 MICHELIN XHA2.	
	FAN				
482322	COLD WEATHER PACKAGE	1,723.00	782511	FULL FENDERS W/RH & LH STEPS	1,056.00
424223	EJECTOR TYPE PRECLEANER	421.00	782441	STANDARD HYDRAULIC	
				STEERING	
726013	REMOTE JUMP START		782503	RIDE CONTROL	
782777	OPERATOR CONVENIENCE		734054	JOYSTICK WITH 1 AUX FUNCTION	
	PACKAGE				
734064	TWO-TONE GRAY TRIM		734186	NO TRANSMISSION CONTROL	
				UNIT	
734005	RIGHT/LEFT HEATED MIRRORS		469817	ADVANCED CONNECTIVITY	
469491	3" SEAT BELT - HIGH VISIBILITY		469825	TELEMATICS 5YR CUSTOMER	
				PORTAL	
782440	CAB WITH HEATER AND A/C			Total List Price	\$290,530.00



621G

EFFECTIVE APRIL 2021

Z-BAR/XT/XR WHEEL LOADER

TIER 4 FINAL CERTIFIED



ENGINE

Make	FPT
Model	F4HFE613W
Emissions Certification	Tier 4 Final
Emissions Technology	SCR/DOC
Type	4-stroke, turbocharged and air-to-air cooled
Cylinders	6-cylinder in-line
Bore/Stroke	4.09 x 5.20 in (104 x 132 mm)
Displacement	411 in ³ (6.7 L)
Fuel	#2 Diesel, #1 and #2 mixture permitted for cold temperatures
Fuel injection	Direct injection – electronic
Fuel filter	Replaceable
Fuel pump	Bosch
Gradeability:	
Side-to-side	35°
Fore and aft	35°
Air filter	Dry type elements w/ warning restriction indicator
Mid-mount cooling module w/ auto reversing fan:	
Mid-mount Air/Water w/ Lube Oil Cooler	
Fan – hydraulic driven:	
Style	8 blade puller
Diameter	32 in (813 mm)
Water pump	Integral
Engine oil pump operating angle ratings:	
Side-to-side	35°
Fore and aft	35°
Oil filtration	Replaceable
Engine speeds	RPM
Rated – full load	2000
Horsepower – Maximum Power:	
Peak gross @ 1800 RPM	172 hp (128 kW)
Net rated @ 2000 RPM	151 hp (113 kW)
Peak net @ 1800 RPM	162 hp (121 kW)
Torque – Maximum Power:	
Gross @ 1600 RPM	538 lb-ft (730 N-m)
Net @ 1600 RPM	510 lb-ft (692 N-m)
Net torque rise:	
Maximum power range	29%

NOTE: Gross horsepower and torque per SAE J1995. Net horsepower and torque per SAE J1349.

DRIVETRAIN

Transmission:		
4F/3R Proportional w/ Electronic Control		
Module torque sensing autoshift/manual shift and modulation		
Gears	Helical cut	
Gear ratios – 4-speed	Forward/Reverse	
1st	4.012/3.804	
2nd	2.174/2.061	
3rd	1.088/1.031	
4th	0.619/ –	
Gear ratios – 5-speed	Forward/Reverse	
1st	4.320/4.097	
2nd	2.191/2.078	
3rd	1.418/0.895	
4th	0.944/ –	
5th	0.611/ –	
Torque converter:		
Stall ratio – 4-speed	2.664:1	
Stall ratio – 5-speed	2.376:1	
Differential:		
Limited slip w/ 34% of available axle torque to wheel w/ traction		
Rear axle oscillation	24° total	
Front and rear axles:		
Differential ratio	3.18	
Planetary ratio	6.40	
Final axle ratio	20.34	
Heavy-duty axles – optional:		
Front axle equipped w/ locking differential		
Rear axle equipped w/ open differential		
Planetaries	Outboard	
Service brakes:		
Hydraulically actuated, maintenance-free, multiple wet disc w/ accumulator to all four wheels		
Brake surface area:		
Front hub – each	480 in ² (0.31 m ²)	
Rear hub – each	480 in ² (0.31 m ²)	
Parking brakes:		
Spring-applied hydraulic release disc on transmission output shaft neutralizes power flow to wheels when engaged		
Travel speeds – 4-speed transmission:		
	Forward	Reverse
	mph (kph)	mph (kph)
1st	4.3 (6.9)	4.5 (7.3)
2nd	8.4 (13.5)	8.8 (14.2)
3rd	14.9 (23.9)	15.6 (25.0)
4th	24.0 (38.6)	–
Travel speeds – 5-speed transmission:		
	Forward	Reverse
	mph (kph)	mph (kph)
1st	4.0 (6.5)	4.3 (6.9)
2nd	8.3 (13.3)	8.7 (14.0)
3rd	12.7 (20.5)	20.1 (32.4)
4th	19.1 (30.7)	–
5th	28.0 (45.0)	–

NOTE: Travel speeds at full engine throttle w/ 20.5-R25 (L3 Radial) tires.

ELECTRICAL

Voltage	24 Volts, negative ground
Alternator	120 amp
Batteries (2)	12-volt

OPERATOR ENVIRONMENT

ROPS cab AC w/ heat; 8" LCD touchscreen display, adjustable armrest w/ 3 configurable buttons; Key start; Articulated power steering w/ tilt column; Fully adjustable, suspension seat w/ headrest; Foot throttle; Single lever (joystick) loader control w/ auxiliary function and fully adjustable wrist rest, 2 cup holders; Interior rear view mirror; 3 inch (76 mm) retractable seat belt; Integrated 4-corner strobe; Multiple storage trays; Single brake pedal; F/N/R shuttle switch; Left and Right external side mirrors; Pressurized air filtering; Anti-glare window strip; Front and Rear Defroster; Side window, partial/fully open; 2 Dome lights; Wipers, rear and intermittent front; Windshield washers, front and rear; Rubber floor mat; Horn; Radio ready – Includes antenna, speakers, wiring, radio fuse, 20A converter, 12-volt auxiliary power outlet, and USB outlet.

Displays/Gauges:

Digital:
Transmission oil temperature; Engine coolant temperature; Fuel level; DEF level.

LCD screen:

Hour meter; Engine speed; Travel speed; Time; Automatic transmission indication; Current gear selection; FNR indication; DeClutch indication; Engine mode indication; Trip computer A/B; Fuel consumption; Multiple languages, Metric/English; Engine diagnostics; Transmission diagnostics; Warning prompts; Error reporting; Diff. lock*; DEF gauge.

Audible/Visual alarms:

Warning lights:
Four-way flashers and turn signals; Brake pressure; Lamp/high beam indication; Engine block heater.

Caution warnings:

Parking brake; Coolant temperature; Hydraulic oil temperature; Transmission oil temperature; Air filter; Transmission filter; Hydraulic filter; Alternator; Low fuel.

Critical warnings:

Engine oil pressure; Brake pressure; Steering pressure – w/ aux. steering*; Coolant temperature; Hydraulic oil temperature; Transmission oil temperature.

Backup alarm

Maintenance reminders:

Cab air filter; Engine oil filter; Fuel pre-filter; DEF tank vent filter; SCR supply filter; Hydraulic oil and filter; Engine air filter; Engine coolant; Drive belt; Cab recirculation filter; Engine breather filter; Transmission breather; Front and rear axle fluid; SCR supply module filter.

NOTE: *if equipped w/ option.

OPERATING WEIGHT

Z-Bar

Unit equipped w/ 2.75 yd³ (2.1 m³) Case pin on bucket w/ edge; 20.5-R25 L3 Radial tires; ROPS cab w/ heater and A/C; Std. battery; Heavy counterweight – 1,950 lb (885 kg); Front and rear fenders; Lights; 165 lb (75 kg) operator:
28,159 lb (12 773 kg)

XT

Unit equipped w/ 2.5 yd³ (1.9 m³) CNH w/ edge and JRB coupler; 20.5-R25 L3 Radial tires; ROPS cab w/ heater and A/C; Std. battery; Heavy counterweight – 1,950 lb (885 kg); Front and rear fenders; Lights; 165 lb (75 kg) operator:
28,076 lb (13 188 kg)

XR

Unit equipped w/ 2.5 yd³ (1.9 m³) Case pin on bucket w/ edge; 20.5-R25 L3 Radial tires; ROPS cab w/ heater and A/C; Std. battery; Heavy counterweight – 1,950 lb (885 kg); Front and rear fenders; Lights; 165 lb (75 kg) operator:
28,483 lb (12 920 kg)

HYDRAULICS

Pump – steering/implement:

Closed center pressure/flow compensated

Variable displacement – load-sensing:

45.2 gpm @ 2000 RPM
(171 L/min @ 2000 RPM)

Loader control valve:

Closed-center, sectional 2, 3 or 4-function
w/ control for lift, tilt and auxiliary hydraulics

Loader auxiliary steering:

Hydraulic orbital center-pivot articulating
w/ on-demand oil flow

High pressure standby:

Implement 3,625 psi (25 000 kPa)
Steering 3,500 psi (24 132 kPa)

Filtration:

Filtered vent w/ relief on hydraulic reservoir,
maintains 3-5 psi on reservoir, 10-micron, return
filter furnishes only clean oil to all components
of the system

SERVICE CAPACITIES

Fuel tank 65.0 gal (246.0 L)

DEF tank – Diesel Exhaust Fluid:

Usable capacity 9.8 gal (37.1 L)
Total 15.6 gal (58.9 L)

Hydraulic system:

Reservoir 24.0 gal (90.8 L)
Total 39.0 gal (147.6 L)

Transmission:

Service w/ filter 29.2 qt (27.6 L)

Front and rear axle:

Front axle 23.2 qt (22.0 L)
Rear axle 23.2 qt (22.0 L)

Front and rear axle – optional:

Front axle 23.2 qt (22.0 L)
Rear axle 23.2 qt (22.0 L)

Engine oil w/ filter 14 qt (13.2 L)

Cooling system 28.4 qt (26.8 L)

OTHER SPECIFICATIONS

Lift cylinder:

Bore diameter 4.7 in (120.6 mm)
Rod diameter 2.5 in (63.5 mm)
Stroke 31.0 in (787.6 mm)

Dump cylinder – Z-Bar and XR:

Bore diameter 5.0 in (127 mm)
Rod diameter 3.0 in (76.2 mm)
Stroke 24.4 in (619.7 mm)

Dump cylinder – XT:

Bore diameter 4.5 in (114 mm)
Rod diameter 2.5 in (63.5 mm)
Stroke 32.6 in (819.9 mm)

Loader:

Z-Bar loader linkage; Single control for
lift and tilt; Positive hold float; Automatic
return-to-dig; Automatic height control;
Automatic return-to-travel; Brake pedal
transmission disconnect; Bucket position
indicator on bucket.

Cycle time:

Raise w/ rated bucket load:
Z-Bar 6.3 sec
XR 6.3 sec
XT 6.5 sec

Dump w/ rated bucket load:

Z-Bar 1.2 sec
XR 1.2 sec
XT 2.4 sec

Float down:

Z-Bar 4.8 sec
XR 4.8 sec
XT 4.2 sec

Sound level in Cab (LpA) 68 dB(A)

Exterior sound level (LwA) 104 dB(A)

NOTE: Sound level data tested in accordance
with ISO6395, 6396, 3744.

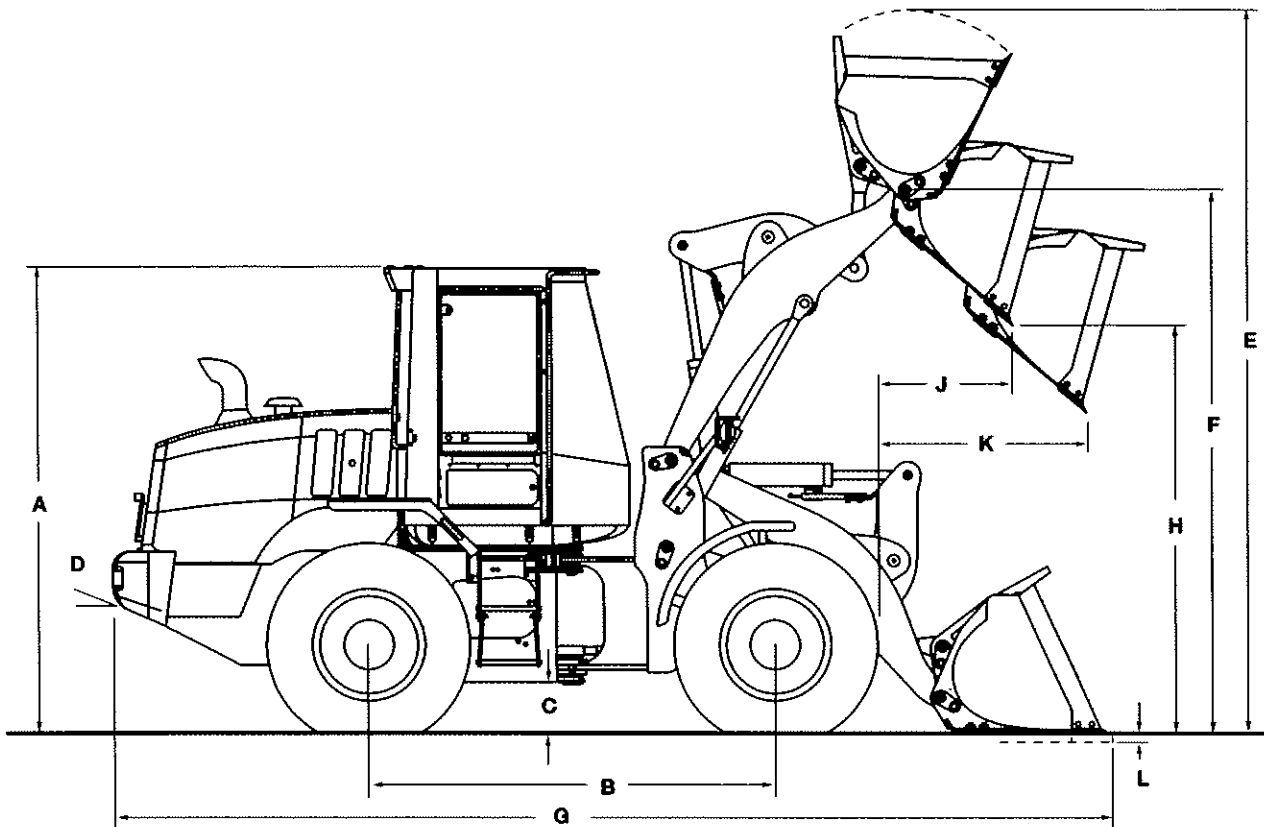

Line drawings are for illustrative purpose only and may not be exact representation of unit.

DIMENSIONS

A. Height to top of ROPS cab	133.2 in (3 384 mm)
Height to drawbar	42.1 in (1 070 mm)
B. Wheelbase	114.2 in (2 900 mm)
C. Ground clearance	15.3 in (389 mm)
D. Angle of departure	25°
Width:	
Overall* without bucket	97.6 in (2 478 mm)
Tread width	76.8 in (1 950 mm)
Turning radius* – outside	205.6 in (5 223 mm)
Turning angle:	
From center	40°
Total angle	80°
Rear axle oscillation – total	24°

NOTE: *Dimensions taken with 20.5-R25 (L3 Radial) tires. For transport dimensions, refer to specific bucket width and overall length on pages 4 through 9.

WEIGHT ADJUSTMENTS

Select Options	Weight Adjustment	Tipping Load Adjustment	
		Straight: Deflected*	40° Turn: Deflected*
20.5 x 25 12 ply L2 Bias tires	-592 lb (-269 kg)	-618 lb (-280 kg)	-1,179 lb (-535 kg)
20.5 x 25 12 ply L3 Bias tires	-20 lb (-9 kg)	+240 lb (+109 kg)	+363 lb (+165 kg)
20.5-R25 L2 Radial tires	-256 lb (-116 kg)	-259 lb (-117 kg)	-189 lb (-86 kg)
20.5-R25 Snow Radial Tires	-132 lb (-60 kg)	-175 lb (-79 kg)	-111 lb (-50 kg)
20.5-R25 Solid Tires Req. Diff Axles, Ltd Speed Controller	+4,782 lb (+2 169 kg)	+3,140 lb (+1 424 kg)	+3,327 lb (+1 509 kg)

NOTE: Unit equipped with Z-Bar loader arms, 2.5 yd³ (1.9 m³) general purpose pin on bucket with bolt-on edge, 20.5-R25 (L3 Radial) tires, ROPS cab with heater and air conditioner, heavy counterweight, standard batteries, front and rear fenders, full fuel and 165 lb (79 kg) operator. Adjust select options from rated weight. *Tipping loads: ISO 14397-1 Deflected Tires.

PERFORMANCE SPECS

621G Z-Bar*		3.0 yd³ (2.3 m³) Bucket with Bolt-on Edge - Pin On	2.5 yd³ (1.9 m³) Bucket with Bolt-on Edge - Pin On	2.4 yd³ (1.8 m³) Bucket with Teeth Only - Pin On	4.5 yd³ (3.4 m³) Bucket with Bolt-on Edge - Pin On
Operating weight		28,254 lb (12 816 kg)	28,093 lb (12 743 kg)	28,013 lb (12 707 kg)	28,672 lb (13 005 kg)
E. Operating height – fully raised with spillguard		198.6 in (5 044 mm)	194.5 in (4 941 mm)	194.5 in (4 941 mm)	212.9 in (5 408 mm)
F. Hinge pin height – fully raised		150.9 in (3 833 mm)	150.9 in (3 833 mm)	150.9 in (3 834 mm)	150.9 in (3 833 mm)
G. Overall length – bucket level on ground		290.6 in (7 380 mm)	284.9 in (7 237 mm)	290.6 in (7 382 mm)	302.9 in (7 694 mm)
Dump angle – fully raised		51°	51°	51°	50°
H. Dump height – fully raised, 45° dump		110.4 in (2 804 mm)	114.1 in (2 899 mm)	110.4 in (2 805 mm)	102.2 in (2 596 mm)
J. Bucket reach – fully raised, 45° dump		39.8 in (1 010 mm)	36.0 in (916 mm)	40.2 in (1 021 mm)	47.9 in (1 216 mm)
K. Bucket reach – 7 ft 0 in (2.13 m) height, 45° dump		59.6 in (1 513 mm)	57.7 in (1 466 mm)	60.0 in (1 525 mm)	62.9 in (1 598 mm)
L. Dig depth		3.3 in (84 mm)	2.8 in (72 mm)	3.0 in (76 mm)	4.4 in (111 mm)
Operating load – ISO Rigid Tires		10,299 lb (4 671 kg)	10,569 lb (4 794 kg)	10,703 lb (4 855 kg)	9,637 lb (4 371 kg)
Operating load – ISO Deflected Tires		9,375 lb (4 252 kg)	9,633 lb (4 369 kg)	9,756 lb (4 425 kg)	8,737 lb (3 963 kg)
Maximum material density – ISO Rigid Tires		3,433 lb/yd ³ (2 037 kg/m ³)	4,228 lb/yd ³ (2 509 kg/m ³)	4,460 lb/yd ³ (2 646 kg/m ³)	2,142 lb/yd ³ (1 271 kg/m ³)
Maximum material density – ISO Deflected Tires		3,125 lb/yd ³ (1 854 kg/m ³)	3,853 lb/yd ³ (2 286 kg/m ³)	4,065 lb/yd ³ (2 412 kg/m ³)	1,942 lb/yd ³ (1 152 kg/m ³)
Tippling load – ISO Rigid Tires:					
	Straight	23,725 lb (10 761 kg)	24,318 lb (11 030 kg)	24,612 lb (11 164 kg)	22,275 lb (10 104 kg)
	40° turn	20,597 lb (9 343 kg)	21,138 lb (9 588 kg)	21,407 lb (9 710 kg)	19,274 lb (8 742 kg)
Tippling load – ISO Deflected Tires:					
	Straight	22,307 lb (10 118 kg)	22,881 lb (10 378 kg)	23,155 lb (10 503 kg)	20,896 lb (9 478 kg)
	40° turn	18,749 lb (8 504 kg)	19,266 lb (8 739 kg)	19,511 lb (8 850 kg)	17,474 lb (7 926 kg)
Lift capacity:					
	Full height	16,266 lb (7 378 kg)	16,442 lb (7 458 kg)	16,530 lb (7 498 kg)	15,794 lb (7 164 kg)
	Ground	22,395 lb (10 158 kg)	25,278 lb (11 466 kg)	26,875 lb (12 100 kg)	21,930 lb (9 947 kg)
Breakout force with tilt cylinder		24,031 lb (10 900 kg)	27,260 lb (12 374 kg)	29,182 lb (13 237 kg)	18,285 lb (8 294 kg)
Loader clearance circle with bucket		455.1 in (11 560 mm)	451.9 in (11 478 mm)	454.8 in (11 552 mm)	462.3 in (11 743 mm)

621G XR		3.0 yd³ (2.3 m³) Bucket with Bolt-on Edge - Pin On	2.5 yd³ (1.9 m³) Bucket with Bolt-on Edge - Pin On	2.4 yd³ (1.8 m³) Bucket with Teeth Only - Pin On	4.5 yd³ (3.4 m³) Bucket with Bolt-on Edge - Pin On
Operating weight		28,644 lb (12 993 kg)	28,483 lb (12 920 kg)	28,403 lb (12 883 kg)	29,062 lb (13 182 kg)
E. Operating height – fully raised with spillguard		215.3 in (5 469 mm)	211.2 in (5 365 mm)	211.2 in (5 365 mm)	229.6 in (5 833 mm)
F. Hinge pin height – fully raised		167.6 in (4 258 mm)	167.6 in (4 258 mm)	167.6 in (4 258 mm)	167.6 in (4 257 mm)
G. Overall length – bucket level on ground		306.7 in (7 789 mm)	301.1 in (7 648 mm)	306.8 in (7 792 mm)	318.8 in (8 099 mm)
Dump angle – fully raised		45°	45°	45°	45°
H. Dump height – fully raised, 45° dump		127.1 in (3 229 mm)	130.8 in (3 323 mm)	127.1 in (3 229 mm)	119.2 in (3 027 mm)
J. Bucket reach – fully raised, 45° dump		39.8 in (1 011 mm)	36.1 in (916 mm)	40.2 in (1 022 mm)	48.2 in (1 225 mm)
K. Bucket reach – 7 ft 0 in (2.13 m) height, 45° dump		73.7 in (1 871 mm)	71.6 in (1 817 mm)	74.1 in (1 883 mm)	77.7 in (1 973 mm)
L. Dig depth		3.5 in (88 mm)	3.0 in (76 mm)	3.2 in (81 mm)	4.5 in (115 mm)
Operating load – ISO Rigid Tires		8,617 lb (3 909 kg)	8,832 lb (4 006 kg)	8,942 lb (4 056 kg)	8,085 lb (3 667 kg)
Operating load – ISO Deflected Tires		7,938 lb (3 601 kg)	8,146 lb (3 695 kg)	8,248 lb (3 741 kg)	7,420 lb (3 366 kg)
Maximum material density – ISO Rigid Tires		2,872 lb/yd ³ (1 704 kg/m ³)	3,533 lb/yd ³ (2 096 kg/m ³)	3,726 lb/yd ³ (2 211 kg/m ³)	1,797 lb/yd ³ (1 066 kg/m ³)
Maximum material density – ISO Deflected Tires		2,646 lb/yd ³ (1 570 kg/m ³)	3,259 lb/yd ³ (1 933 kg/m ³)	3,437 lb/yd ³ (2 039 kg/m ³)	1,649 lb/yd ³ (978 kg/m ³)
Tippling load – ISO Rigid Tires:					
	Straight	19,948 lb (9 048 kg)	20,416 lb (9 261 kg)	20,653 lb (9 368 kg)	18,791 lb (8 523 kg)
	40° turn	17,234 lb (7 817 kg)	17,665 lb (8 013 kg)	17,883 lb (8 112 kg)	16,170 lb (7 335 kg)
Tippling load – ISO Deflected Tires:					
	Straight	18,927 lb (8 585 kg)	19,385 lb (8 793 kg)	19,609 lb (8 895 kg)	17,792 lb (8 070 kg)
	40° turn	15,876 lb (7 201 kg)	16,293 lb (7 390 kg)	16,496 lb (7 482 kg)	14,840 lb (6 731 kg)
Lift capacity:					
	Full height	15,791 lb (7 162 kg)	15,959 lb (7 239 kg)	16,044 lb (7 277 kg)	15,308 lb (6 944 kg)
	Ground	25,246 lb (11 451 kg)	25,759 lb (11 684 kg)	25,976 lb (11 783 kg)	24,802 lb (11 250 kg)
Breakout force with tilt cylinder		24,720 lb (11 213 kg)	28,096 lb (12 744 kg)	30,037 lb (13 625 kg)	18,751 lb (8 505 kg)
Loader clearance circle with bucket		470.7 in (11 956 mm)	467.0 in (11 862 mm)	470.4 in (11 948 mm)	478.1 in (12 144 mm)

621G		Z-Bar/XR	Z-Bar/XR	Z-Bar/XR	Z-Bar/XR
Maximum rollback:					
	Ground	41°/40°	40°/40°	40°/40°	42°/42°
	Carry position	45°/45°	45°/45°	45°/45°	45°/47°
	⊙ Full height	55°/59°	55°/59°	55°/59°	55°/59°
Maximum grading angle with bucket – back dragging		59°/59°	58°/58°	59°/59°	64°/63°
SAE bucket capacity – struck		2.56 yd ³ (1.96 m ³)	2.15 yd ³ (1.64 m ³)	2.05 yd ³ (1.57 m ³)	3.71 yd ³ (2.84 m ³)
Heaped		3.00 yd ³ (2.29 m ³)	2.50 yd ³ (1.91 m ³)	2.40 yd ³ (1.83 m ³)	4.50 yd ³ (3.44 m ³)
Bucket width – outside		102.4 in (2 602 mm)	102.4 in (2 602 mm)	102.1 in (2 593 mm)	102.4 in (2 602 mm)
Bucket weight		1,957 lb (888 kg)	1,796 lb (814 kg)	1,716 lb (778 kg)	2,374 lb (1 077 kg)

PERFORMANCE SPEGS

621G Z-Bar*		3.0 yd³ (2.29 m³) Bucket with Bolt-on Edge - JRB Coupler	2.8 yd³ (2.14 m³) Bucket with Teeth - JRB Coupler	2.5 yd³ (1.91 m³) Bucket with Bolt-on Edge - JRB Coupler	2.4 yd³ (1.8 m³) Bucket with Teeth - JRB Coupler
Operating weight		29,119 lb (13 208 kg)	29,039 lb (13 172 kg)	28,930 lb (13 122 kg)	28,852 lb (13 087 kg)
E. Operating height – fully raised with spillguard		205.1 in (5 209 mm)	205.1 in (5 209 mm)	200.4 in (5 090 mm)	200.4 in (5 090 mm)
F. Hinge pin height – fully raised		150.9 in (3 832 mm)	150.9 in (3 832 mm)	150.9 in (3 832 mm)	150.9 in (3 832 mm)
G. Overall length – bucket level on ground		299.2 in (7 601 mm)	305.0 in (7 746 mm)	293.7 in (7 460 mm)	299.4 in (7 604 mm)
Dump angle – fully raised		51°	51°	51°	51°
H. Dump height – fully raised, 45° dump		104.9 in (2 664 mm)	101.2 in (2 570 mm)	108.5 in (2 755 mm)	104.8 in (2 661 mm)
J. Bucket reach – fully raised, 45° dump		47.0 in (1 193 mm)	51.1 in (1 299 mm)	42.7 in (1 085 mm)	46.9 in (1 191 mm)
K. Bucket reach – 7 ft 0 in (2.13 m) height, 45° dump		63.7 in (1 618 mm)	65.5 in (1 664 mm)	61.5 in (1 562 mm)	63.6 in (1 614 mm)
L. Dig depth		2.9 in (73 mm)	3.0 in (77 mm)	2.9 in (73 mm)	3.0 in (77 mm)
Operating load – ISO Rigid Tires		9,271 lb (4 205 kg)	9,398 lb (4 263 kg)	9,500 lb (4 309 kg)	9,619 lb (4 363 kg)
Operating load – ISO Deflected Tires		8,407 lb (3 813 kg)	8,522 lb (3 866 kg)	8,631 lb (3 915 kg)	8,739 lb (3 964 kg)
Maximum material density – ISO Rigid Tires		3,090 lb/yd ³ (1 834 kg/m ³)	3,356 lb/yd ³ (1 992 kg/m ³)	3,800 lb/yd ³ (2 255 kg/m ³)	4,008 lb/yd ³ (2 378 kg/m ³)
Maximum material density – ISO Deflected Tires		2,802 lb/yd ³ (1 663 kg/m ³)	3,044 lb/yd ³ (1 806 kg/m ³)	3,452 lb/yd ³ (2 048 kg/m ³)	3,641 lb/yd ³ (2 161 kg/m ³)
Tipping load – ISO Rigid Tires:	Straight	21,483 lb (9 744 kg)	21,760 lb (9 870 kg)	21,978 lb (9 969 kg)	22,238 lb (10 087 kg)
	40° turn	18,543 lb (8 411 kg)	18,796 lb (8 526 kg)	18,999 lb (8 618 kg)	19,238 lb (8 726 kg)
Tipping load – ISO Deflected Tires:	Straight	20,161 lb (9 145 kg)	20,420 lb (9 262 kg)	20,649 lb (9 366 kg)	20,892 lb (9 476 kg)
	40° turn	16,813 lb (7 626 kg)	17,045 lb (7 731 kg)	17,261 lb (7 830 kg)	17,478 lb (7 928 kg)
Lift capacity:	Full height	15,397 lb (6 984 kg)	15,452 lb (7 009 kg)	15,564 lb (7 060 kg)	15,649 lb (7 098 kg)
	Ground	20,923 lb (9 491 kg)	16,177 lb (7 338 kg)	16,975 lb (7 700 kg)	17,704 lb (8 030 kg)
Breakout force with tilt cylinder		18,868 lb (8 558 kg)	20,530 lb (9 312 kg)	21,896 lb (9 932 kg)	23,163 lb (10 506 kg)
Loader clearance circle with bucket		460.2 in (11 689 mm)	463.4 in (11 771 mm)	456.9 in (11 605 mm)	460.0 in (11 683 mm)

621G XR		3.0 yd³ (2.29 m³) Bucket with Bolt-on Edge - JRB Coupler	2.8 yd³ (2.14 m³) Bucket with Teeth - JRB Coupler	2.5 yd³ (1.91 m³) Bucket with Bolt-on Edge - JRB Coupler	2.4 yd³ (1.8 m³) Bucket with Teeth - JRB Coupler
Operating weight		29,508 lb (13 385 kg)	29,428 lb (13 348 kg)	29,319 lb (13 299 kg)	29,241 lb (13 264 kg)
E. Operating height – fully raised with spillguard		221.8 in (5 634 mm)	221.8 in (5 634 mm)	217.1 in (5 514 mm)	217.1 in (5 514 mm)
F. Hinge pin height – fully raised		167.6 in (4 257 mm)	167.6 in (4 257 mm)	167.6 in (4 257 mm)	167.6 in (4 257 mm)
G. Overall length – bucket level on ground		315.4 in (8 011 mm)	321.1 in (8 156 mm)	309.8 in (7 870 mm)	315.5 in (8 014 mm)
Dump angle – fully raised		45°	45°	45°	45°
H. Dump height – fully raised, 45° dump		121.6 in (3 088 mm)	117.9 in (2 995 mm)	125.2 in (3 179 mm)	121.5 in (3 086 mm)
J. Bucket reach – fully raised, 45° dump		47.0 in (1 194 mm)	51.2 in (1 300 mm)	42.8 in (1 086 mm)	46.9 in (1 192 mm)
K. Bucket reach – 7 ft 0 in (2.13 m) height, 45° dump		78.2 in (1 987 mm)	80.4 in (2 041 mm)	75.7 in (1 924 mm)	78.1 in (1 983 mm)
L. Dig depth		3.1 in (78 mm)	3.2 in (82 mm)	3.1 in (78 mm)	3.2 in (81 mm)
Operating load – ISO Rigid Tires		7,764 lb (3 522 kg)	7,868 lb (3 569 kg)	7,953 lb (3 608 kg)	8,052 lb (3 652 kg)
Operating load – ISO Deflected Tires		7,120 lb (3 230 kg)	7,218 lb (3 274 kg)	7,308 lb (3 315 kg)	7,400 lb (3 357 kg)
Maximum material density – ISO Rigid Tires		2,588 lb/yd ³ (1 536 kg/m ³)	2,810 lb/yd ³ (1 667 kg/m ³)	3,181 lb/yd ³ (1 888 kg/m ³)	3,355 lb/yd ³ (1 991 kg/m ³)
Maximum material density – ISO Deflected Tires		2,373 lb/yd ³ (1 408 kg/m ³)	2,578 lb/yd ³ (1 530 kg/m ³)	2,923 lb/yd ³ (1 735 kg/m ³)	3,083 lb/yd ³ (1 830 kg/m ³)
Tipping load – ISO Rigid Tires:	Straight	18,102 lb (8 211 kg)	18,329 lb (8 314 kg)	18,509 lb (8 396 kg)	18,723 lb (8 493 kg)
	40° turn	15,527 lb (7 043 kg)	15,736 lb (7 138 kg)	15,907 lb (7 215 kg)	16,104 lb (7 305 kg)
Tipping load – ISO Deflected Tires:	Straight	17,137 lb (7 773 kg)	17,354 lb (7 872 kg)	17,542 lb (7 957 kg)	17,745 lb (8 049 kg)
	40° turn	14,241 lb (6 459 kg)	14,436 lb (6 548 kg)	14,616 lb (6 630 kg)	14,800 lb (6 713 kg)
Lift capacity:	Full height	14,924 lb (6 769 kg)	14,995 lb (6 802 kg)	15,104 lb (6 851 kg)	15,186 lb (6 888 kg)
	Ground	24,358 lb (11 049 kg)	23,528 lb (10 672 kg)	23,788 lb (10 790 kg)	23,995 lb (10 884 kg)
Breakout force with tilt cylinder		19,474 lb (8 833 kg)	21,155 lb (9 596 kg)	22,571 lb (10 238 kg)	23,864 lb (10 824 kg)
Loader clearance circle with bucket		476.2 in (12 095 mm)	479.8 in (12 187 mm)	472.4 in (12 000 mm)	476.0 in (12 089 mm)

621G		Z-Bar/XR	Z-Bar/XR	Z-Bar/XR	Z-Bar/XR
Maximum rollback:	Ground	40°/40°	40°/40°	40°/40°	40°/40°
	Carry position	45°/46°	45°/46°	45°/46°	45°/46°
	⊙ Full height	55°/59°	55°/59°	55°/59°	55°/59°
Maximum grading angle with bucket – back dragging		62°/61°	64°/62°	60°/60°	62°/61°
SAE bucket capacity – struck		2.60 yd ³ (1.99 m ³)	2.40 yd ³ (1.83 m ³)	2.15 yd ³ (1.64 m ³)	2.05 yd ³ (1.57 m ³)
	Heaped	3.00 yd ³ (2.29 m ³)	2.80 yd ³ (2.14 m ³)	2.50 yd ³ (1.91 m ³)	2.40 yd ³ (1.83 m ³)
Bucket width – outside		102.4 in (2 602 mm)	102.1 in (2 593 mm)	102.4 in (2 602 mm)	102.1 in (2 593 mm)
Bucket weight		2,821 lb (1 280 kg)	2,741 lb (1 243 kg)	2,632 lb (1 194 kg)	2,554 lb (1 158 kg)

PERFORMANCE SPECS

621G Z-Bar*		3.0 yd³ (2.29 m³) Bucket with Bolt-on Edge - ACS Coupler	2.8 yd³ (2.14 m³) Bucket with Teeth - ACS Coupler	2.5 yd³ (1.91 m³) Bucket with Bolt-on Edge - ACS Coupler	2.4 yd³ (1.8 m³) Bucket with Teeth - ACS Coupler
Operating weight		29,322 lb (13 300 kg)	29,242 lb (13 264 kg)	29,109 lb (13 203 kg)	29,028 lb (13 167 kg)
E. Operating height – fully raised with spillguard		203.7 in (5 173 mm)	203.7 in (5 173 mm)	199.2 in (5 059 mm)	199.2 in (5 059 mm)
F. Hinge pin height – fully raised		150.9 in (3 832 mm)	150.9 in (3 832 mm)	150.9 in (3 832 mm)	150.9 in (3 832 mm)
G. Overall length – bucket level on ground		297.3 in (7 551 mm)	303.0 in (7 696 mm)	292.0 in (7 418 mm)	297.7 in (7 562 mm)
Dump angle – fully raised		51°	51°	51°	51°
H. Dump height – fully raised, 45° dump		106.1 in (2 696 mm)	102.4 in (2 602 mm)	109.5 in (2 782 mm)	105.8 in (2 688 mm)
J. Bucket reach – fully raised, 45° dump		45.5 in (1 155 mm)	49.6 in (1 260 mm)	41.5 in (1 053 mm)	45.6 in (1 158 mm)
K. Bucket reach – 7 ft 0 in (2.13 m) height, 45° dump		62.9 in (1 598 mm)	64.8 in (1 646 mm)	60.8 in (1 545 mm)	62.9 in (1 597 mm)
L. Dig depth		2.9 in (74 mm)	3.1 in (78 mm)	2.9 in (73 mm)	3.1 in (78 mm)
Operating load – ISO Rigid Tires		9,329 lb (4 232 kg)	9,456 lb (4 289 kg)	9,542 lb (4 328 kg)	9,662 lb (4 383 kg)
Operating load – ISO Deflected Tires		8,450 lb (3 833 kg)	8,566 lb (3 886 kg)	8,661 lb (3 928 kg)	8,771 lb (3 978 kg)
Maximum material density – ISO Rigid Tires		3,110 lb/yd ³ (1 845 kg/m ³)	3,377 lb/yd ³ (2 004 kg/m ³)	3,817 lb/yd ³ (2 265 kg/m ³)	4,026 lb/yd ³ (2 389 kg/m ³)
Maximum material density – ISO Deflected Tires		2,817 lb/yd ³ (1 671 kg/m ³)	3,059 lb/yd ³ (1 815 kg/m ³)	3,464 lb/yd ³ (2 056 kg/m ³)	3,655 lb/yd ³ (2 188 kg/m ³)
Tipping load – ISO Rigid Tires:	Straight	21,642 lb (9 817 kg)	21,921 lb (9 943 kg)	22,099 lb (10 024 kg)	22,361 lb (10 143 kg)
	40° turn	18,658 lb (8 463 kg)	18,913 lb (8 579 kg)	19,084 lb (8 656 kg)	19,324 lb (8 765 kg)
Tipping load – ISO Deflected Tires:	Straight	20,296 lb (9 206 kg)	20,558 lb (9 325 kg)	20,750 lb (9 412 kg)	20,996 lb (9 524 kg)
	40° turn	16,899 lb (7 665 kg)	17,133 lb (7 771 kg)	17,321 lb (7 857 kg)	17,542 lb (7 957 kg)
Lift capacity:	Full height	15,175 lb (6 883 kg)	15,263 lb (6 923 kg)	15,396 lb (6 984 kg)	15,483 lb (7 023 kg)
	Ground	16,546 lb (7 505 kg)	17,354 lb (7 871 kg)	17,992 lb (8 161 kg)	18,795 lb (8 525 kg)
Breakout force with tilt cylinder		20,212 lb (9 168 kg)	21,315 lb (9 668 kg)	22,635 lb (10 267 kg)	24,003 lb (10 887 kg)
Loader clearance circle with bucket		459.0 in (11 659 mm)	462.2 in (11 740 mm)	455.9 in (11 580 mm)	459.0 in (11 658 mm)
621G XR		3.0 yd³ (2.29 m³) Bucket with Bolt-on Edge - ACS Coupler	2.8 yd³ (2.14 m³) Bucket with Teeth - ACS Coupler	2.5 yd³ (1.91 m³) Bucket with Bolt-on Edge - ACS Coupler	2.4 yd³ (1.8 m³) Bucket with Teeth - ACS Coupler
Operating weight		29,711 lb (13 477 kg)	29,831 lb (13 440 kg)	29,498 lb (13 380 kg)	29,418 lb (13 344 kg)
E. Operating height – fully raised with spillguard		220.4 in (5 597 mm)	220.4 in (5 597 mm)	215.9 in (5 484 mm)	215.9 in (5 484 mm)
F. Hinge pin height – fully raised		167.6 in (4 256 mm)	167.6 in (4 256 mm)	167.6 in (4 257 mm)	167.6 in (4 257 mm)
G. Overall length – bucket level on ground		313.4 in (7 961 mm)	319.1 in (8 106 mm)	308.2 in (7 828 mm)	313.9 in (7 972 mm)
Dump angle – fully raised		45°	45°	45°	45°
H. Dump height – fully raised, 45° dump		122.9 in (3 121 mm)	119.2 in (3 027 mm)	126.2 in (3 206 mm)	122.5 in (3 113 mm)
J. Bucket reach – fully raised, 45° dump		45.5 in (1 156 mm)	49.7 in (1 261 mm)	41.5 in (1 054 mm)	45.6 in (1 159 mm)
K. Bucket reach – 7 ft 0 in (2.13 m) height, 45° dump		77.3 in (1 965 mm)	79.6 in (2 021 mm)	75.0 in (1 904 mm)	77.3 in (1 964 mm)
L. Dig depth		3.1 in (78 mm)	3.2 in (82 mm)	3.1 in (78 mm)	3.2 in (82 mm)
Operating load – ISO Rigid Tires		7,779 lb (3 528 kg)	7,883 lb (3 576 kg)	7,960 lb (3 611 kg)	8,059 lb (3 656 kg)
Operating load – ISO Deflected Tires		7,127 lb (3 233 kg)	7,225 lb (3 277 kg)	7,307 lb (3 314 kg)	7,400 lb (3 357 kg)
Maximum material density – ISO Rigid Tires		2,593 lb/yd ³ (1 539 kg/m ³)	2,816 lb/yd ³ (1 671 kg/m ³)	3,184 lb/yd ³ (1 889 kg/m ³)	3,358 lb/yd ³ (1 993 kg/m ³)
Maximum material density – ISO Deflected Tires		2,376 lb/yd ³ (1 410 kg/m ³)	2,580 lb/yd ³ (1 531 kg/m ³)	2,923 lb/yd ³ (1 734 kg/m ³)	3,083 lb/yd ³ (1 830 kg/m ³)
Tipping load – ISO Rigid Tires:	Straight	18,165 lb (8 240 kg)	18,393 lb (8 343 kg)	18,549 lb (8 414 kg)	18,765 lb (8 512 kg)
	40° turn	15,558 lb (7 057 kg)	15,767 lb (7 152 kg)	15,920 lb (7 221 kg)	16,118 lb (7 311 kg)
Tipping load – ISO Deflected Tires:	Straight	17,187 lb (7 796 kg)	17,404 lb (7 894 kg)	17,570 lb (7 970 kg)	17,775 lb (8 063 kg)
	40° turn	14,254 lb (6 466 kg)	14,450 lb (6 554 kg)	14,614 lb (6 629 kg)	14,800 lb (6 713 kg)
Lift capacity:	Full height	14,715 lb (6 675 kg)	14,799 lb (6 713 kg)	14,931 lb (6 772 kg)	15,015 lb (6 811 kg)
	Ground	23,380 lb (10 605 kg)	23,606 lb (10 707 kg)	23,840 lb (10 814 kg)	24,049 lb (10 908 kg)
Breakout force with tilt cylinder		20,843 lb (9 454 kg)	21,967 lb (9 964 kg)	23,336 lb (10 585 kg)	24,730 lb (11 217 kg)
Loader clearance circle with bucket		474.8 in (12 061 mm)	478.4 in (12 152 mm)	471.4 in (11 973 mm)	474.9 in (12 061 mm)
621G	Z-Bar/XR	Z-Bar/XR	Z-Bar/XR	Z-Bar/XR	Z-Bar/XR
Maximum rollback:	Ground	40°/40°	40°/40°	40°/40°	40°/40°
	Carry position	45°/46°	45°/46°	45°/46°	45°/46°
	⊙ Full height	55°/59°	55°/59°	55°/59°	55°/59°
Maximum grading angle with bucket – back dragging		61°/60°	63°/81°	60°/60°	61°/60°
SAE bucket capacity – struck		2.60 yd ³ (1.99 m ³)	2.40 yd ³ (1.83 m ³)	2.15 yd ³ (1.64 m ³)	2.05 yd ³ (1.57 m ³)
	Heaped	3.00 yd ³ (2.29 m ³)	2.80 yd ³ (2.14 m ³)	2.50 yd ³ (1.91 m ³)	2.40 yd ³ (1.83 m ³)
Bucket width – outside		102.4 in (2 602 mm)	102.1 in (2 593 mm)	102.4 in (2 602 mm)	102.1 in (2 593 mm)
Bucket weight		3,024 lb (1 372 kg)	2,944 lb (1 335 kg)	2,811 lb (1 275 kg)	2,731 lb (1 239 kg)

PERFORMANCE SPECS

621G XT		3.0 yd³ (2.29 m³) Bucket with Bolt-on Edge - JRB Coupler	2.8 yd³ (2.14 m³) Bucket with Teeth - JRB Coupler	2.5 yd³ (1.91 m³) Bucket with Bolt-on Edge - JRB Coupler	2.4 yd³ (1.8 m³) Bucket with Teeth - JRB Coupler
Operating weight		29,519 lb (13 389 kg)	29,442 lb (13 355 kg)	29,332 lb (13 305 kg)	29,253 lb (13 269 kg)
E. Operating height – fully raised with spillguard		216.7 in (5 505 mm)	216.7 in (5 505 mm)	212.0 in (5 386 mm)	212.0 in (5 386 mm)
F. Hinge pin height – fully raised		155.9 in (3 960 mm)	155.9 in (3 960 mm)	155.9 in (3 960 mm)	155.9 in (3 960 mm)
G. Overall length – bucket level on ground		307.8 in (7 818 mm)	313.5 in (7 963 mm)	302.2 in (7 676 mm)	307.7 in (7 817 mm)
Dump angle – fully raised		55°	55°	55°	55°
H. Dump height – fully raised, 45° dump		104.3 in (2 648 mm)	100.6 in (2 554 mm)	107.8 in (2 739 mm)	104.3 in (2 648 mm)
J. Bucket reach – fully raised, 45° dump		55.5 in (1 409 mm)	59.6 in (1 515 mm)	51.2 in (1 301 mm)	55.2 in (1 402 mm)
K. Bucket reach – 7 ft 0 in (2.13 m) height, 45° dump		72.2 in (1 833 mm)	73.9 in (1 878 mm)	70.1 in (1 780 mm)	71.9 in (1 827 mm)
L. Dig depth		2.5 in (62 mm)	2.6 in (66 mm)	2.4 in (62 mm)	2.6 in (66 mm)
Operating load – ISO Rigid Tires		8,506 lb (3 858 kg)	8,616 lb (3 908 kg)	8,704 lb (3 948 kg)	8,421 lb (3 820 kg)
Operating load – ISO Deflected Tires		7,672 lb (3 480 kg)	7,774 lb (3 526 kg)	7,867 lb (3 568 kg)	7,617 lb (3 455 kg)
Maximum material density – ISO Rigid Tires		2,835 lb/yd ³ (1 682 kg/m ³)	3,077 lb/yd ³ (1 826 kg/m ³)	3,482 lb/yd ³ (2 066 kg/m ³)	3,509 lb/yd ³ (2 082 kg/m ³)
Maximum material density – ISO Deflected Tires		2,557 lb/yd ³ (1 517 kg/m ³)	2,776 lb/yd ³ (1 647 kg/m ³)	3,147 lb/yd ³ (1 867 kg/m ³)	3,174 lb/yd ³ (1 883 kg/m ³)
Tipping load – ISO Rigid Tires:					
	Straight	19,723 lb (8 946 kg)	19,963 lb (9 055 kg)	20,149 lb (9 140 kg)	19,480 lb (8 836 kg)
	40° turn	17,012 lb (7 716 kg)	17,233 lb (7 817 kg)	17,409 lb (7 896 kg)	16,843 lb (7 640 kg)
Tipping load – ISO Deflected Tires:					
	Straight	18,456 lb (8 372 kg)	18,683 lb (8 474 kg)	18,877 lb (8 562 kg)	18,262 lb (8 283 kg)
	40° turn	15,344 lb (6 960 kg)	15,548 lb (7 052 kg)	15,733 lb (7 136 kg)	15,235 lb (6 910 kg)
Lift capacity:					
	Full height	13,913 lb (6 311 kg)	14,055 lb (6 375 kg)	14,175 lb (6 430 kg)	13,985 lb (6 344 kg)
	Ground	26,995 lb (12 245 kg)	28,110 lb (12 750 kg)	28,545 lb (12 948 kg)	24,581 lb (11 150 kg)
Breakout force with tilt cylinder		20,671 lb (9 376 kg)	21,613 lb (9 803 kg)	22,854 lb (10 366 kg)	24,077 lb (10 921 kg)
Loader clearance circle with bucket		453.4 in (11 517 mm)	455.5 in (11 569 mm)	451.2 in (11 460 mm)	453.1 in (11 509 mm)

621G XT		3.0 yd³ (2.29 m³) Bucket with Bolt-on Edge - ACS Coupler	2.8 yd³ (2.14 m³) Bucket with Teeth - ACS Coupler	2.5 yd³ (1.91 m³) Bucket with Bolt-on Edge - ACS Coupler	2.4 yd³ (1.8 m³) Bucket with Teeth - ACS Coupler
Operating weight		29,852 lb (13 541 kg)	29,774 lb (13 505 kg)	29,639 lb (13 444 kg)	29,561 lb (13 409 kg)
E. Operating height – fully raised with spillguard		212.1 in (5 387 mm)	212.1 in (5 387 mm)	207.6 in (5 274 mm)	207.6 in (5 274 mm)
F. Hinge pin height – fully raised		155.9 in (3 959 mm)	155.9 in (3 959 mm)	155.9 in (3 959 mm)	155.9 in (3 959 mm)
G. Overall length – bucket level on ground		301.8 in (7 666 mm)	307.5 in (7 810 mm)	296.6 in (7 533 mm)	302.3 in (7 678 mm)
Dump angle – fully raised		55°	55°	55°	55°
H. Dump height – fully raised, 45° dump		108.1 in (2 745 mm)	104.4 in (2 653 mm)	111.5 in (2 831 mm)	107.8 in (2 737 mm)
J. Bucket reach – fully raised, 45° dump		50.9 in (1 293 mm)	55.1 in (1 399 mm)	46.9 in (1 191 mm)	51.0 in (1 296 mm)
K. Bucket reach – 7 ft 0 in (2.13 m) height, 45° dump		69.9 in (1 776 mm)	71.9 in (1 826 mm)	67.7 in (1 721 mm)	69.8 in (1 774 mm)
L. Dig depth		2.5 in (63 mm)	2.6 in (65 mm)	2.5 in (62 mm)	2.6 in (67 mm)
Operating load – ISO Rigid Tires		8,755 lb (3 971 kg)	8,871 lb (4 024 kg)	8,948 lb (4 059 kg)	9,058 lb (4 109 kg)
Operating load – ISO Deflected Tires		7,883 lb (3 576 kg)	7,990 lb (3 624 kg)	8,077 lb (3 684 kg)	8,178 lb (3 709 kg)
Maximum material density – ISO Rigid Tires		2,918 lb/yd ³ (1 732 kg/m ³)	3,168 lb/yd ³ (1 880 kg/m ³)	3,579 lb/yd ³ (2 124 kg/m ³)	3,774 lb/yd ³ (2 239 kg/m ³)
Maximum material density – ISO Deflected Tires		2,628 lb/yd ³ (1 559 kg/m ³)	2,854 lb/yd ³ (1 693 kg/m ³)	3,231 lb/yd ³ (1 917 kg/m ³)	3,407 lb/yd ³ (2 022 kg/m ³)
Tipping load – ISO Rigid Tires:					
	Straight	20,330 lb (9 221 kg)	20,584 lb (9 337 kg)	20,741 lb (9 408 kg)	20,981 lb (9 517 kg)
	40° turn	17,509 lb (7 942 kg)	17,742 lb (8 048 kg)	17,895 lb (8 117 kg)	18,116 lb (8 217 kg)
Tipping load – ISO Deflected Tires:					
	Straight	19,002 lb (8 619 kg)	19,241 lb (8 727 kg)	19,415 lb (8 806 kg)	19,640 lb (8 908 kg)
	40° turn	15,766 lb (7 152 kg)	15,980 lb (7 248 kg)	16,154 lb (7 327 kg)	16,356 lb (7 419 kg)
Lift capacity:					
	Full height	13,929 lb (6 318 kg)	14,074 lb (6 384 kg)	14,197 lb (6 440 kg)	14,337 lb (6 503 kg)
	Ground	32,621 lb (14 797 kg)	34,152 lb (15 491 kg)	34,382 lb (15 596 kg)	35,919 lb (16 293 kg)
Breakout force with tilt cylinder		22,941 lb (10 406 kg)	24,092 lb (10 928 kg)	25,446 lb (11 542 kg)	26,841 lb (12 175 kg)
Loader clearance circle with bucket		451.0 in (11 456 mm)	453.0 in (11 506 mm)	449.0 in (11 405 mm)	450.9 in (11 454 mm)

621G		JRB/ACS	JRB/ACS	JRB/ACS	JRB/ACS
Maximum rollback:					
	Ground	57°/57°	57°/57°	57°/57°	57°/57°
	Carry position	59°/59°	59°/59°	59°/59°	59°/59°
	⊗ Full height	59°/59°	59°/59°	59°/59°	59°/59°
Maximum grading angle with bucket – back dragging		83°/62°	64°/63°	62°/60°	63°/62°
SAE bucket capacity – struck					
	Heaped	2.60 yd ³ (1.99 m ³)	2.40 yd ³ (1.83 m ³)	2.15 yd ³ (1.64 m ³)	2.05 yd ³ (1.57 m ³)
		3.00 yd ³ (2.29 m ³)	2.80 yd ³ (2.14 m ³)	2.50 yd ³ (1.91 m ³)	2.40 yd ³ (1.83 m ³)
Bucket width – outside		102.4 in (2 602 mm)	102.1 in (2 593 mm)	102.4 in (2 602 mm)	102.1 in (2 593 mm)
Bucket weight		2,797 lb/3,131 lb (1 269 kg)/(1 420 kg)	2,721 lb/3,053 lb (1 234 kg)/(1 385 kg)	2,610 lb/2,918 lb (1 184 kg)/(1 324 kg)	2,532 lb/2,840 lb (1 149 kg)/(1 288 kg)

NOTE: *Z-Bar performance data shown with full counterweight. Performance data unit equipped with 20.5-R25 Michelin XTLA (L2 Radial) tires, ROPS cab with heater and A/C, full counterweight, standard batteries, front and rear fenders, full fuel and 165 lb (75 kg) operator. Specifications per SAE J732, J1234, J695, J742 and J818.

STANDARD EQUIPMENT

OPERATOR ENVIRONMENT

See page 1

ENGINE

CASE/FPT F4HFE613W
Tier 4 Final Certified
Selective Catalytic Reduction (SCR) with Diesel Oxidation Catalyst
Selectable work modes:
Maximum Mode
Smart Mode
Turbocharger
Charge air cooling
Automatic belt tensioner
Integral engine oil cooling
Fuel filter with water trap
Dual-element dry-type air cleaner
Hydraulic-driven cooling fan
Air-cooled radiator
Mid-mounted cooling module with hydraulically driven auto-reversing fan
Engine block heater
Common rail electronic fuel injection

LOADER

See page 2 – Operating weight,
Other specifications

DRIVETRAIN

4-wheel drive
4F/3R Selectable autoshift/manual shift transmission
Electronic Control Module – programmable, computer controlled proportional shifting with programmable gear selection
Onboard diagnostics
Single lever electronic shift control
F/N/R switch in loader control handle
Downshift button
Torque converter
Limited-slip differentials – Z-Bar
Outboard planetary axles
Transmission oil cooler
Brake pedal transmission disconnect – declutch
Hydraulic wet disc brakes
Spring-applied hydraulic release parking brake
Limp-Home Mode
Greaseable rear axle trunnion
3-piece rims

HYDRAULICS

Adjustable Electro-hydraulic - EH loader control with one auxiliary function and 3 configurable buttons
Adjustable EH controls:
Smooth
Moderate
Aggressive
Auxiliary Hydraulics
Ride Control™
Locking hydraulics for hydraulic coupler
EH Parallel Lift
Low-effort steering
Hydraulic driven cooling fan
Diagnostic quick couplers
Hydraulic oil cooler

ELECTRICAL

Alternator and voltage regulator
Battery Isolator/electrical disconnect
120 amp alternator
(2) 700 CCA 12-volt batteries
Electric starter
Lights:
Integrated 4-corner strobe
2 Front and 2 rear halogen flood lights
2 Front driving headlights – high/low beam with integrated turn signals
2 LED stop/tail lights with integrated turn signals
Key start/stop switch
Backup alarm
Centrally located fuse box with all electrical circuits protected
Remote jump start posts

OTHER

Electric hood lift
Front and rear fenders, partial coverage
External rear view mirrors
Heavy counterweight
Drawbar hitch
Articulation locking bar
Lift arm locking bar
Lift and tie-down points – front/rear
Rear frame side covers
License plate brackets; front bracket and lit rear bracket
Rubber steering stops
Grouped remote-mounted ecology drains:
Engine oil
Engine coolant
Hydraulic oil

TELEMATICS

CASE SiteWatch™ Telematics – includes hardware and a 3-yr Advanced data subscription
SiteConnect Module providing remote diagnostics capability

OPTIONAL EQUIPMENT

OPERATOR ENVIRONMENT

Cloth-covered heated air-suspension seat with headrest
Sound Shield noise suppression package
Bluetooth radio, 12V AM/FM with auxiliary input
Cab convenience package:
Rear sun shade, interior mirror, under the seat drawer, coat hook, 12V accessory port, and an ash tray
In cab powered cooler box
In cab accessory mount
Rear view camera
External heated rear view mirrors
Front LED driving/headlights
LED front and rear work lights – 4 front, 2 rear

DRIVETRAIN

5F/3R Autoshift/manual shift transmission, lockup torque converter, PowerInch de-clutch
Heavy-duty axles:
With locking front differential and open/conventional rear differential
Cold weather package:
Heavy-duty (2) 950 CCA 12V batteries
Fuel heater
Hydraulic oil cooler bypass
Low temperature hydraulic oil
Fast-warm hydraulic valve

HYDRAULICS

Secondary steering
Integrated Payload System
Tire Pressure Monitoring System
2-spool loader valves with joystick loader control
4-function loader valve with joystick loader control and two proportional auxiliary roller switches

LOADER

XR extended reach version
XT tool carrier version
Attachment auxiliary hydraulics
Coupler systems – JRB or ACS compatible
Buckets – see pages 4 through 8

TIRES

20.5x25 L2 bias (16 ply) – dirt/traction
20.5 x25 L3 bias (16 ply) – rock
20.5-R25 L2 radial – dirt/traction
20.5-R25 L3 radial – rock
20.5-R25 radial Michelin SnoPlus
Axle oscillation stops

GUARDING

Skid plate, transmission and front chassis bottom guards

ADVANCED ENGINE AIR FILTRATION

Heavy Debris cooling system:
Stanted cooling module cover
Increased cooling fin spacing
Added cooling module sealing
Sy-Klone® ejector type pre-cleaner

OTHER

Additional RH steps and platform with standard or wide fenders
12.4 mph (20 kph) maximum speed control
Special paint
Standard fenders with right and left hand steps
Wide full coverage fenders with right and left hand steps

CaseCE.com

©2021 CNH Industrial America LLC. All rights reserved. CASE is a trademark registered in the United States and many other countries, owned by or licensed to CNH Industrial N.V., its subsidiaries or affiliates. CNH Industrial Capital is a trademark in the United States and many other countries, owned by or licensed to CNH Industrial N.V., its subsidiaries or affiliates. Printed in U.S.A. Contains 10% post-consumer fiber.

IMPORTANT: CASE Construction Equipment Inc. reserves the right to change these specifications without notice and without incurring any obligation relating to such change. Availability of some models and equipment builds vary according to the country in which the equipment is used. The illustrations and text may include optional equipment and accessories and may not include all standard equipment. Your CASE dealer/distributor will be able to give you details of the products and their specifications available in your area.



CASE Construction Equipment is biodiesel-friendly. NOTE: All engines meet current EPA emissions regulations. All specifications are stated in accordance with SAE Standards or Recommended Practices, where applicable.



Always read the Operator's Manual before operating any equipment. Inspect equipment before using it, and be sure it is operating properly. Follow the product safety signs and use any safety features provided.

Form No. CCE202104621G
Replaces Form No. CCE201910621G



Solicitation Number: RFP # 011723

CONTRACT

This Contract is between Sourcewell, 202 12th Street Northeast, P.O. Box 219, Staples, MN 56479 (Sourcewell) and CNH Industrial America LLC, 700 State Street, Racine, WI 53404 (Supplier).

Sourcewell is a State of Minnesota local government unit and service cooperative created under the laws of the State of Minnesota (Minnesota Statutes Section 123A.21) that offers cooperative procurement solutions to government entities. Participation is open to eligible federal, state/province, and municipal governmental entities, higher education, K-12 education, nonprofit, tribal government, and other public entities located in the United States and Canada. Sourcewell issued a public solicitation for Heavy Construction Equipment with Related Attachments and Technology from which Supplier was awarded a contract.

Supplier desires to contract with Sourcewell to provide equipment, products, or services to Sourcewell and the entities that access Sourcewell's cooperative purchasing contracts (Participating Entities).

1. TERM OF CONTRACT

- A. **EFFECTIVE DATE.** This Contract is effective upon the date of the final signature below.
- B. **EXPIRATION DATE AND EXTENSION.** This Contract expires April 14, 2027, unless it is cancelled sooner pursuant to Article 22. This Contract may be extended one additional year upon the request of Sourcewell and written agreement by Supplier.
- C. **SURVIVAL OF TERMS.** Notwithstanding any expiration or termination of this Contract, all payment obligations incurred prior to expiration or termination will survive, as will the following: Articles 11 through 14 survive the expiration or cancellation of this Contract. All other rights will cease upon expiration or termination of this Contract.

2. EQUIPMENT, PRODUCTS, OR SERVICES

- A. **EQUIPMENT, PRODUCTS, OR SERVICES.** Supplier will provide the Equipment, Products, or Services as stated in its Proposal submitted under the Solicitation Number listed above.

Supplier's Equipment, Products, or Services Proposal (Proposal) is attached and incorporated into this Contract.

All Equipment and Products provided under this Contract must be new and the current model. Supplier may offer close-out or refurbished Equipment or Products if they are clearly indicated in Supplier's product and pricing list. Unless agreed to by the Participating Entities in advance, Equipment or Products must be delivered as operational to the Participating Entity's site.

This Contract offers an indefinite quantity of sales, and while substantial volume is anticipated, sales and sales volume are not guaranteed.

B. **WARRANTY.** Supplier warrants that all Equipment, Products, and Services furnished are free from liens and encumbrances, and are free from defects in design, materials, and workmanship. In addition, Supplier warrants the Equipment, Products, and Services are suitable for and will perform in accordance with the ordinary use for which they are intended. Supplier's dealers and distributors must agree to assist the Participating Entity in reaching a resolution in any dispute over warranty terms with the manufacturer. Any manufacturer's warranty that extends beyond the expiration of the Supplier's warranty will be passed on to the Participating Entity.

C. **DEALERS, DISTRIBUTORS, AND/OR RESELLERS.** Upon Contract execution and throughout the Contract term, Supplier must provide to Sourcewell a current means to validate or authenticate Supplier's authorized dealers, distributors, or resellers relative to the Equipment, Products, and Services offered under this Contract, which will be incorporated into this Contract by reference. It is the Supplier's responsibility to ensure Sourcewell receives the most current information.

3. PRICING

All Equipment, Products, or Services under this Contract will be priced at or below the price stated in Supplier's Proposal.

When providing pricing quotes to Participating Entities, all pricing quoted must reflect a Participating Entity's total cost of acquisition. This means that the quoted cost is for delivered Equipment, Products, and Services that are operational for their intended purpose, and includes all costs to the Participating Entity's requested delivery location.

Regardless of the payment method chosen by the Participating Entity, the total cost associated with any purchase option of the Equipment, Products, or Services must always be disclosed in the pricing quote to the applicable Participating Entity at the time of purchase.

A. **SHIPPING AND SHIPPING COSTS.** All delivered Equipment and Products must be properly packaged. Damaged Equipment and Products may be rejected. If the damage is not readily apparent at the time of delivery, Supplier must permit the Equipment and Products to be returned within a reasonable time at no cost to Sourcewell or its Participating Entities.

Participating Entities reserve the right to inspect the Equipment and Products at a reasonable time after delivery where circumstances or conditions prevent effective inspection of the Equipment and Products at the time of delivery. In the event of the delivery of nonconforming Equipment and Products, the Participating Entity will notify the Supplier as soon as possible and the Supplier will replace nonconforming Equipment and Products with conforming Equipment and Products that are acceptable to the Participating Entity.

Supplier must arrange for and pay for the return shipment on Equipment and Products that arrive in a defective or inoperable condition.

Sourcwell may declare the Supplier in breach of this Contract if the Supplier intentionally delivers substandard or inferior Equipment or Products.

B. SALES TAX. Each Participating Entity is responsible for supplying the Supplier with valid tax-exemption certification(s). When ordering, a Participating Entity must indicate if it is a tax-exempt entity.

C. HOT LIST PRICING. At any time during this Contract, Supplier may offer a specific selection of Equipment, Products, or Services at discounts greater than those listed in the Contract. When Supplier determines it will offer Hot List Pricing, it must be submitted electronically to Sourcwell in a line-item format. Equipment, Products, or Services may be added or removed from the Hot List at any time through a Sourcwell Price and Product Change Form as defined in Article 4 below.

Hot List program and pricing may also be used to discount and liquidate close-out and discontinued Equipment and Products as long as those close-out and discontinued items are clearly identified as such. Current ordering process and administrative fees apply. Hot List Pricing must be published and made available to all Participating Entities.

4. PRODUCT AND PRICING CHANGE REQUESTS

Supplier may request Equipment, Product, or Service changes, additions, or deletions at any time. All requests must be made in writing by submitting a signed Sourcwell Price and Product Change Request Form to the assigned Sourcwell Supplier Development Administrator. This approved form is available from the assigned Sourcwell Supplier Development Administrator. At a minimum, the request must:

- Identify the applicable Sourcwell contract number;
- Clearly specify the requested change;
- Provide sufficient detail to justify the requested change;
- Individually list all Equipment, Products, or Services affected by the requested change, along with the requested change (e.g., addition, deletion, price change); and

- Include a complete restatement of pricing documentation in Microsoft Excel with the effective date of the modified pricing, or product addition or deletion. The new pricing restatement must include all Equipment, Products, and Services offered, even for those items where pricing remains unchanged.

A fully executed Sourcwell Price and Product Request Form will become an amendment to this Contract and will be incorporated by reference.

5. PARTICIPATION, CONTRACT ACCESS, AND PARTICIPATING ENTITY REQUIREMENTS

A. **PARTICIPATION.** Sourcwell's cooperative contracts are available and open to public and nonprofit entities across the United States and Canada; such as federal, state/province, municipal, K-12 and higher education, tribal government, and other public entities.

The benefits of this Contract should be available to all Participating Entities that can legally access the Equipment, Products, or Services under this Contract. A Participating Entity's authority to access this Contract is determined through its cooperative purchasing, interlocal, or joint powers laws. Any entity accessing benefits of this Contract will be considered a Service Member of Sourcwell during such time of access. Supplier understands that a Participating Entity's use of this Contract is at the Participating Entity's sole convenience and Participating Entities reserve the right to obtain like Equipment, Products, or Services from any other source.

Supplier is responsible for familiarizing its sales and service forces with Sourcwell contract use eligibility requirements and documentation and will encourage potential participating entities to join Sourcwell. Sourcwell reserves the right to add and remove Participating Entities to its roster during the term of this Contract.

B. **PUBLIC FACILITIES.** Supplier's employees may be required to perform work at government-owned facilities, including schools. Supplier's employees and agents must conduct themselves in a professional manner while on the premises, and in accordance with Participating Entity policies and procedures, and all applicable laws.

6. PARTICIPATING ENTITY USE AND PURCHASING

A. **ORDERS AND PAYMENT.** To access the contracted Equipment, Products, or Services under this Contract, a Participating Entity must clearly indicate to Supplier that it intends to access this Contract; however, order flow and procedure will be developed jointly between Sourcwell and Supplier. Typically, a Participating Entity will issue an order directly to Supplier or its authorized subsidiary, distributor, dealer, or reseller. If a Participating Entity issues a purchase order, it may use its own forms, but the purchase order should clearly note the applicable Sourcwell contract number. All Participating Entity orders under this Contract must be issued prior to expiration or cancellation of this Contract; however, Supplier performance, Participating Entity

payment obligations, and any applicable warranty periods or other Supplier or Participating Entity obligations may extend beyond the term of this Contract.

Supplier's acceptable forms of payment are included in its attached Proposal. Participating Entities will be solely responsible for payment and Sourcewell will have no liability for any unpaid invoice of any Participating Entity.

B. ADDITIONAL TERMS AND CONDITIONS/PARTICIPATING ADDENDUM. Additional terms and conditions to a purchase order, or other required transaction documentation, may be negotiated between a Participating Entity and Supplier, such as job or industry-specific requirements, legal requirements (e.g., affirmative action or immigration status requirements), or specific local policy requirements. Some Participating Entities may require the use of a Participating Addendum, the terms of which will be negotiated directly between the Participating Entity and the Supplier or its authorized dealers, distributors, or resellers, as applicable. Any negotiated additional terms and conditions must never be less favorable to the Participating Entity than what is contained in this Contract.

C. SPECIALIZED SERVICE REQUIREMENTS. In the event that the Participating Entity requires service or specialized performance requirements not addressed in this Contract (such as e-commerce specifications, specialized delivery requirements, or other specifications and requirements), the Participating Entity and the Supplier may enter into a separate, standalone agreement, apart from this Contract. Sourcewell, including its agents and employees, will not be made a party to a claim for breach of such agreement.

D. TERMINATION OF ORDERS. Participating Entities may terminate an order, in whole or in part, immediately upon notice to Supplier in the event of any of the following events:

1. The Participating Entity fails to receive funding or appropriation from its governing body at levels sufficient to pay for the equipment, products, or services to be purchased; or
2. Federal, state, or provincial laws or regulations prohibit the purchase or change the Participating Entity's requirements.

E. GOVERNING LAW AND VENUE. The governing law and venue for any action related to a Participating Entity's order will be determined by the Participating Entity making the purchase.

7. CUSTOMER SERVICE

A. PRIMARY ACCOUNT REPRESENTATIVE. Supplier will assign an Account Representative to Sourcewell for this Contract and must provide prompt notice to Sourcewell if that person is changed. The Account Representative will be responsible for:

- Maintenance and management of this Contract;

- Timely response to all Sourcewell and Participating Entity inquiries; and
- Business reviews to Sourcewell and Participating Entities, if applicable.

B. **BUSINESS REVIEWS.** Supplier must perform a minimum of one business review with Sourcewell per contract year. The business review will cover sales to Participating Entities, pricing and contract terms, administrative fees, sales data reports, performance issues, supply issues, customer issues, and any other necessary information.

8. REPORT ON CONTRACT SALES ACTIVITY AND ADMINISTRATIVE FEE PAYMENT

A. **CONTRACT SALES ACTIVITY REPORT.** Each calendar quarter, Supplier must provide a contract sales activity report (Report) to the Sourcewell Supplier Development Administrator assigned to this Contract. Reports are due no later than 45 days after the end of each calendar quarter. A Report must be provided regardless of the number or amount of sales during that quarter (i.e., if there are no sales, Supplier must submit a report indicating no sales were made).

The Report must contain the following fields:

- Participating Entity Name (e.g., City of Staples Highway Department);
- Participating Entity Physical Street Address;
- Participating Entity City;
- Participating Entity State/Province;
- Participating Entity Zip/Postal Code;
- Participating Entity Contact Name;
- Participating Entity Contact Email Address;
- Participating Entity Contact Telephone Number;
- Sourcewell Assigned Entity/Participating Entity Number;
- Item Purchased Description;
- Item Purchased Price;
- Sourcewell Administrative Fee Applied; and
- Date Purchase was invoiced/sale was recognized as revenue by Supplier.

B. **ADMINISTRATIVE FEE.** In consideration for the support and services provided by Sourcewell, the Supplier will pay an administrative fee to Sourcewell on all Equipment, Products, and Services provided to Participating Entities. The Administrative Fee must be included in, and not added to, the pricing. Supplier may not charge Participating Entities more than the contracted price to offset the Administrative Fee.

The Supplier will submit payment to Sourcewell for the percentage of administrative fee stated in the Proposal multiplied by the total sales of all Equipment, Products, and Services purchased by Participating Entities under this Contract during each calendar quarter. Payments should

note the Supplier's name and Sourcewell-assigned contract number in the memo; and must be mailed to the address above "Attn: Accounts Receivable" or remitted electronically to Sourcewell's banking institution per Sourcewell's Finance department instructions. Payments must be received no later than 45 calendar days after the end of each calendar quarter.

Supplier agrees to cooperate with Sourcewell in auditing transactions under this Contract to ensure that the administrative fee is paid on all items purchased under this Contract.

In the event the Supplier is delinquent in any undisputed administrative fees, Sourcewell reserves the right to cancel this Contract and reject any proposal submitted by the Supplier in any subsequent solicitation. In the event this Contract is cancelled by either party prior to the Contract's expiration date, the administrative fee payment will be due no more than 30 days from the cancellation date.

9. AUTHORIZED REPRESENTATIVE

Sourcewell's Authorized Representative is its Chief Procurement Officer.

Supplier's Authorized Representative is the person named in the Supplier's Proposal. If Supplier's Authorized Representative changes at any time during this Contract, Supplier must promptly notify Sourcewell in writing.

10. AUDIT, ASSIGNMENT, AMENDMENTS, WAIVER, AND CONTRACT COMPLETE

A. **AUDIT.** Pursuant to Minnesota Statutes Section 16C.05, subdivision 5, the books, records, documents, and accounting procedures and practices relevant to this Contract are subject to examination by Sourcewell or the Minnesota State Auditor for a minimum of six years from the end of this Contract. This clause extends to Participating Entities as it relates to business conducted by that Participating Entity under this Contract.

B. **ASSIGNMENT.** Neither party may assign or otherwise transfer its rights or obligations under this Contract without the prior written consent of the other party and a fully executed assignment agreement. Such consent will not be unreasonably withheld. Any prohibited assignment will be invalid.

C. **AMENDMENTS.** Any amendment to this Contract must be in writing and will not be effective until it has been duly executed by the parties.

D. **WAIVER.** Failure by either party to take action or assert any right under this Contract will not be deemed a waiver of such right in the event of the continuation or repetition of the circumstances giving rise to such right. Any such waiver must be in writing and signed by the parties.

E. **CONTRACT COMPLETE.** This Contract represents the complete agreement between the parties. No other understanding regarding this Contract, whether written or oral, may be used to bind either party. For any conflict between the attached Proposal and the terms set out in Articles 1-22 of this Contract, the terms of Articles 1-22 will govern.

F. **RELATIONSHIP OF THE PARTIES.** The relationship of the parties is one of independent contractors, each free to exercise judgment and discretion with regard to the conduct of their respective businesses. This Contract does not create a partnership, joint venture, or any other relationship such as master-servant, or principal-agent.

11. INDEMNITY AND HOLD HARMLESS

Supplier must indemnify, defend, save, and hold Sourcewell and its Participating Entities, including their agents and employees, harmless from any claims or causes of action, including attorneys' fees incurred by Sourcewell or its Participating Entities, arising out of any act or omission in the performance of this Contract by the Supplier or its agents or employees; this indemnification includes injury or death to person(s) or property alleged to have been caused by some defect in the Equipment, Products, or Services under this Contract to the extent the Equipment, Product, or Service has been used according to its specifications. Sourcewell's responsibility will be governed by the State of Minnesota's Tort Liability Act (Minnesota Statutes Chapter 466) and other applicable law.

12. GOVERNMENT DATA PRACTICES

Supplier and Sourcewell must comply with the Minnesota Government Data Practices Act, Minnesota Statutes Chapter 13, as it applies to all data provided by or provided to Sourcewell under this Contract and as it applies to all data created, collected, received, maintained, or disseminated by the Supplier under this Contract.

13. INTELLECTUAL PROPERTY, PUBLICITY, MARKETING, AND ENDORSEMENT

A. INTELLECTUAL PROPERTY

1. *Grant of License.* During the term of this Contract:
 - a. Sourcewell grants to Supplier a royalty-free, worldwide, non-exclusive right and license to use the trademark(s) provided to Supplier by Sourcewell in advertising and promotional materials for the purpose of marketing Sourcewell's relationship with Supplier.
 - b. Supplier grants to Sourcewell a royalty-free, worldwide, non-exclusive right and license to use Supplier's trademarks in advertising and promotional materials for the purpose of marketing Supplier's relationship with Sourcewell.
2. *Limited Right of Sublicense.* The right and license granted herein includes a limited right of each party to grant sublicenses to their respective subsidiaries, distributors, dealers, resellers, marketing representatives, and agents (collectively "Permitted Sublicensees") in

advertising and promotional materials for the purpose of marketing the Parties' relationship to Participating Entities. Any sublicense granted will be subject to the terms and conditions of this Article. Each party will be responsible for any breach of this Article by any of their respective sublicensees.

3. Use; Quality Control.

- a. Neither party may alter the other party's trademarks from the form provided and must comply with removal requests as to specific uses of its trademarks or logos.
- b. Each party agrees to use, and to cause its Permitted Sublicensees to use, the other party's trademarks only in good faith and in a dignified manner consistent with such party's use of the trademarks. Upon written notice to the breaching party, the breaching party has 30 days of the date of the written notice to cure the breach or the license will be terminated.

4. Termination. Upon the termination of this Contract for any reason, each party, including Permitted Sublicensees, will have 30 days to remove all Trademarks from signage, websites, and the like bearing the other party's name or logo (excepting Sourcewell's pre-printed catalog of suppliers which may be used until the next printing). Supplier must return all marketing and promotional materials, including signage, provided by Sourcewell, or dispose of it according to Sourcewell's written directions.

B. PUBLICITY. Any publicity regarding the subject matter of this Contract must not be released without prior written approval from the Authorized Representatives. Publicity includes notices, informational pamphlets, press releases, research, reports, signs, and similar public notices prepared by or for the Supplier individually or jointly with others, or any subcontractors, with respect to the program, publications, or services provided resulting from this Contract.

C. MARKETING. Any direct advertising, marketing, or offers with Participating Entities must be approved by Sourcewell. Send all approval requests to the Sourcewell Supplier Development Administrator assigned to this Contract.

D. ENDORSEMENT. The Supplier must not claim that Sourcewell endorses its Equipment, Products, or Services.

14. GOVERNING LAW, JURISDICTION, AND VENUE

The substantive and procedural laws of the State of Minnesota will govern this Contract. Venue for all legal proceedings arising out of this Contract, or its breach, must be in the appropriate state court in Todd County, Minnesota or federal court in Fergus Falls, Minnesota.

15. FORCE MAJEURE

Neither party to this Contract will be held responsible for delay or default caused by acts of God or other conditions that are beyond that party's reasonable control. A party defaulting under this provision must provide the other party prompt written notice of the default.

16. SEVERABILITY

If any provision of this Contract is found by a court of competent jurisdiction to be illegal, unenforceable, or void then both parties will be relieved from all obligations arising from that provision. If the remainder of this Contract is capable of being performed, it will not be affected by such determination or finding and must be fully performed.

17. PERFORMANCE, DEFAULT, AND REMEDIES

A. **PERFORMANCE.** During the term of this Contract, the parties will monitor performance and address unresolved contract issues as follows:

1. *Notification.* The parties must promptly notify each other of any known dispute and work in good faith to resolve such dispute within a reasonable period of time. If necessary, Sourcewell and the Supplier will jointly develop a short briefing document that describes the issue(s), relevant impact, and positions of both parties.
2. *Escalation.* If parties are unable to resolve the issue in a timely manner, as specified above, either Sourcewell or Supplier may escalate the resolution of the issue to a higher level of management. The Supplier will have 30 calendar days to cure an outstanding issue.
3. *Performance while Dispute is Pending.* Notwithstanding the existence of a dispute, the Supplier must continue without delay to carry out all of its responsibilities under the Contract that are not affected by the dispute. If the Supplier fails to continue without delay to perform its responsibilities under the Contract, in the accomplishment of all undisputed work, the Supplier will bear any additional costs incurred by Sourcewell and/or its Participating Entities as a result of such failure to proceed.

B. **DEFAULT AND REMEDIES.** Either of the following constitutes cause to declare this Contract, or any Participating Entity order under this Contract, in default:

1. Nonperformance of contractual requirements, or
2. A material breach of any term or condition of this Contract.

The party claiming default must provide written notice of the default, with 30 calendar days to cure the default. Time allowed for cure will not diminish or eliminate any liability for liquidated or other damages. If the default remains after the opportunity for cure, the non-defaulting party may:

- Exercise any remedy provided by law or equity, or
- Terminate the Contract or any portion thereof, including any orders issued against the Contract.

18. INSURANCE

A. REQUIREMENTS. At its own expense, Supplier must maintain insurance policy(ies) in effect at all times during the performance of this Contract with insurance company(ies) licensed or authorized to do business in the State of Minnesota having an "AM BEST" rating of A- or better, with coverage and limits of insurance not less than the following:

1. *Workers' Compensation and Employer's Liability.*

Workers' Compensation: As required by any applicable law or regulation.

Employer's Liability Insurance: must be provided in amounts not less than listed below:

Minimum limits:

\$500,000 each accident for bodily injury by accident

\$500,000 policy limit for bodily injury by disease

\$500,000 each employee for bodily injury by disease

2. *Commercial General Liability Insurance.* Supplier will maintain insurance covering its operations, with coverage on an occurrence basis, and must be subject to terms no less broad than the Insurance Services Office ("ISO") Commercial General Liability Form CG0001 (2001 or newer edition), or equivalent. At a minimum, coverage must include liability arising from premises, operations, bodily injury and property damage, independent contractors, products-completed operations including construction defect, contractual liability, blanket contractual liability, and personal injury and advertising injury. All required limits, terms and conditions of coverage must be maintained during the term of this Contract.

Minimum Limits:

\$1,000,000 each occurrence Bodily Injury and Property Damage

\$1,000,000 Personal and Advertising Injury

\$2,000,000 aggregate for products liability-completed operations

\$2,000,000 general aggregate

3. *Commercial Automobile Liability Insurance.* During the term of this Contract, Supplier will maintain insurance covering all owned, hired, and non-owned automobiles in limits of liability not less than indicated below. The coverage must be subject to terms no less broad than ISO Business Auto Coverage Form CA 0001 (2010 edition or newer), or equivalent.

Minimum Limits:

\$1,000,000 each accident, combined single limit

4. *Umbrella Insurance*. During the term of this Contract, Supplier will maintain umbrella coverage over Employer's Liability, Commercial General Liability, and Commercial Automobile.

Minimum Limits:
\$2,000,000

5. *Network Security and Privacy Liability Insurance*. During the term of this Contract, Supplier will maintain coverage for network security and privacy liability. The coverage may be endorsed on another form of liability coverage or written on a standalone policy. The insurance must cover claims which may arise from failure of Supplier's security resulting in, but not limited to, computer attacks, unauthorized access, disclosure of not public data – including but not limited to, confidential or private information, transmission of a computer virus, or denial of service.

Minimum limits:
\$2,000,000 per occurrence
\$2,000,000 annual aggregate

Failure of Supplier to maintain the required insurance will constitute a material breach entitling Sourcewell to immediately terminate this Contract for default.

B. CERTIFICATES OF INSURANCE. Prior to commencing under this Contract, Supplier must furnish to Sourcewell a certificate of insurance, as evidence of the insurance required under this Contract. Prior to expiration of the policy(ies), renewal certificates must be mailed to Sourcewell, 202 12th Street Northeast, P.O. Box 219, Staples, MN 56479 or sent to the Sourcewell Supplier Development Administrator assigned to this Contract. The certificates must be signed by a person authorized by the insurer(s) to bind coverage on their behalf.

Failure to request certificates of insurance by Sourcewell, or failure of Supplier to provide certificates of insurance, in no way limits or relieves Supplier of its duties and responsibilities in this Contract.

C. ADDITIONAL INSURED ENDORSEMENT AND PRIMARY AND NON-CONTRIBUTORY INSURANCE CLAUSE. Supplier agrees to list Sourcewell and its Participating Entities, including their officers, agents, and employees, as an additional insured under the Supplier's commercial general liability insurance policy with respect to liability arising out of activities, "operations," or "work" performed by or on behalf of Supplier, and products and completed operations of Supplier. The policy provision(s) or endorsement(s) must further provide that coverage is primary and not excess over or contributory with any other valid, applicable, and collectible insurance or self-insurance in force for the additional insureds.

D. WAIVER OF SUBROGATION. Supplier waives and must require (by endorsement or otherwise) all its insurers to waive subrogation rights against Sourcewell and other additional

insureds for losses paid under the insurance policies required by this Contract or other insurance applicable to the Supplier or its subcontractors. The waiver must apply to all deductibles and/or self-insured retentions applicable to the required or any other insurance maintained by the Supplier or its subcontractors. Where permitted by law, Supplier must require similar written express waivers of subrogation and insurance clauses from each of its subcontractors.

E. UMBRELLA/EXCESS LIABILITY/SELF-INSURED RETENTION. The limits required by this Contract can be met by either providing a primary policy or in combination with umbrella/excess liability policy(ies), or self-insured retention.

19. COMPLIANCE

A. LAWS AND REGULATIONS. All Equipment, Products, or Services provided under this Contract must comply fully with applicable federal laws and regulations, and with the laws in the states and provinces in which the Equipment, Products, or Services are sold.

B. LICENSES. Supplier must maintain a valid and current status on all required federal, state/provincial, and local licenses, bonds, and permits required for the operation of the business that the Supplier conducts with Sourcewell and Participating Entities.

20. BANKRUPTCY, DEBARMENT, OR SUSPENSION CERTIFICATION

Supplier certifies and warrants that it is not in bankruptcy or that it has previously disclosed in writing certain information to Sourcewell related to bankruptcy actions. If at any time during this Contract Supplier declares bankruptcy, Supplier must immediately notify Sourcewell in writing.

Supplier certifies and warrants that neither it nor its principals are presently debarred, suspended, proposed for debarment, declared ineligible, or voluntarily excluded from programs operated by the State of Minnesota; the United States federal government or the Canadian government, as applicable; or any Participating Entity. Supplier certifies and warrants that neither it nor its principals have been convicted of a criminal offense related to the subject matter of this Contract. Supplier further warrants that it will provide immediate written notice to Sourcewell if this certification changes at any time.

21. PROVISIONS FOR NON-UNITED STATES FEDERAL ENTITY PROCUREMENTS UNDER UNITED STATES FEDERAL AWARDS OR OTHER AWARDS

Participating Entities that use United States federal grant or FEMA funds to purchase goods or services from this Contract may be subject to additional requirements including the procurement standards of the Uniform Administrative Requirements, Cost Principles and Audit Requirements for Federal Awards, 2 C.F.R. § 200. Participating Entities may have additional

requirements based on specific funding source terms or conditions. Within this Article, all references to “federal” should be interpreted to mean the United States federal government. The following list only applies when a Participating Entity accesses Supplier’s Equipment, Products, or Services with United States federal funds.

A. **EQUAL EMPLOYMENT OPPORTUNITY.** Except as otherwise provided under 41 C.F.R. § 60, all contracts that meet the definition of “federally assisted construction contract” in 41 C.F.R. § 60-1.3 must include the equal opportunity clause provided under 41 C.F.R. §60-1.4(b), in accordance with Executive Order 11246, “Equal Employment Opportunity” (30 FR 12319, 12935, 3 C.F.R. §, 1964-1965 Comp., p. 339), as amended by Executive Order 11375, “Amending Executive Order 11246 Relating to Equal Employment Opportunity,” and implementing regulations at 41 C.F.R. § 60, “Office of Federal Contract Compliance Programs, Equal Employment Opportunity, Department of Labor.” The equal opportunity clause is incorporated herein by reference.

B. **DAVIS-BACON ACT, AS AMENDED (40 U.S.C. § 3141-3148).** When required by federal program legislation, all prime construction contracts in excess of \$2,000 awarded by non-federal entities must include a provision for compliance with the Davis-Bacon Act (40 U.S.C. § 3141-3144, and 3146-3148) as supplemented by Department of Labor regulations (29 C.F.R. § 5, “Labor Standards Provisions Applicable to Contracts Covering Federally Financed and Assisted Construction”). In accordance with the statute, contractors must be required to pay wages to laborers and mechanics at a rate not less than the prevailing wages specified in a wage determination made by the Secretary of Labor. In addition, contractors must be required to pay wages not less than once a week. The non-federal entity must place a copy of the current prevailing wage determination issued by the Department of Labor in each solicitation. The decision to award a contract or subcontract must be conditioned upon the acceptance of the wage determination. The non-federal entity must report all suspected or reported violations to the federal awarding agency. The contracts must also include a provision for compliance with the Copeland “Anti-Kickback” Act (40 U.S.C. § 3145), as supplemented by Department of Labor regulations (29 C.F.R. § 3, “Contractors and Subcontractors on Public Building or Public Work Financed in Whole or in Part by Loans or Grants from the United States”). The Act provides that each contractor or subrecipient must be prohibited from inducing, by any means, any person employed in the construction, completion, or repair of public work, to give up any part of the compensation to which he or she is otherwise entitled. The non-federal entity must report all suspected or reported violations to the federal awarding agency. Supplier must be in compliance with all applicable Davis-Bacon Act provisions.

C. **CONTRACT WORK HOURS AND SAFETY STANDARDS ACT (40 U.S.C. § 3701-3708).** Where applicable, all contracts awarded by the non-federal entity in excess of \$100,000 that involve the employment of mechanics or laborers must include a provision for compliance with 40 U.S.C. §§ 3702 and 3704, as supplemented by Department of Labor regulations (29 C.F.R. § 5). Under 40 U.S.C. § 3702 of the Act, each contractor must be required to compute the wages of every mechanic and laborer on the basis of a standard work week of 40 hours. Work in excess

of the standard work week is permissible provided that the worker is compensated at a rate of not less than one and a half times the basic rate of pay for all hours worked in excess of 40 hours in the work week. The requirements of 40 U.S.C. § 3704 are applicable to construction work and provide that no laborer or mechanic must be required to work in surroundings or under working conditions which are unsanitary, hazardous or dangerous. These requirements do not apply to the purchases of supplies or materials or articles ordinarily available on the open market, or contracts for transportation or transmission of intelligence. This provision is hereby incorporated by reference into this Contract. Supplier certifies that during the term of an award for all contracts by Sourcewell resulting from this procurement process, Supplier must comply with applicable requirements as referenced above.

D. RIGHTS TO INVENTIONS MADE UNDER A CONTRACT OR AGREEMENT. If the federal award meets the definition of "funding agreement" under 37 C.F.R. § 401.2(a) and the recipient or subrecipient wishes to enter into a contract with a small business firm or nonprofit organization regarding the substitution of parties, assignment or performance of experimental, developmental, or research work under that "funding agreement," the recipient or subrecipient must comply with the requirements of 37 C.F.R. § 401, "Rights to Inventions Made by Nonprofit Organizations and Small Business Firms Under Government Grants, Contracts and Cooperative Agreements," and any implementing regulations issued by the awarding agency. Supplier certifies that during the term of an award for all contracts by Sourcewell resulting from this procurement process, Supplier must comply with applicable requirements as referenced above.

E. CLEAN AIR ACT (42 U.S.C. § 7401-7671Q.) AND THE FEDERAL WATER POLLUTION CONTROL ACT (33 U.S.C. § 1251-1387). Contracts and subgrants of amounts in excess of \$150,000 require the non-federal award to agree to comply with all applicable standards, orders or regulations issued pursuant to the Clean Air Act (42 U.S.C. § 7401- 7671q) and the Federal Water Pollution Control Act as amended (33 U.S.C. § 1251- 1387). Violations must be reported to the Federal awarding agency and the Regional Office of the Environmental Protection Agency (EPA). Supplier certifies that during the term of this Contract will comply with applicable requirements as referenced above.

F. DEBARMENT AND SUSPENSION (EXECUTIVE ORDERS 12549 AND 12689). A contract award (see 2 C.F.R. § 180.220) must not be made to parties listed on the government wide exclusions in the System for Award Management (SAM), in accordance with the OMB guidelines at 2 C.F.R. §180 that implement Executive Orders 12549 (3 C.F.R. § 1986 Comp., p. 189) and 12689 (3 C.F.R. § 1989 Comp., p. 235), "Debarment and Suspension." SAM Exclusions contains the names of parties debarred, suspended, or otherwise excluded by agencies, as well as parties declared ineligible under statutory or regulatory authority other than Executive Order 12549. Supplier certifies that neither it nor its principals are presently debarred, suspended, proposed for debarment, declared ineligible, or voluntarily excluded from participation by any federal department or agency.

G. BYRD ANTI-LOBBYING AMENDMENT, AS AMENDED (31 U.S.C. § 1352). Suppliers must file any required certifications. Suppliers must not have used federal appropriated funds to pay any person or organization for influencing or attempting to influence an officer or employee of any agency, a member of Congress, officer or employee of Congress, or an employee of a member of Congress in connection with obtaining any federal contract, grant, or any other award covered by 31 U.S.C. § 1352. Suppliers must disclose any lobbying with non-federal funds that takes place in connection with obtaining any federal award. Such disclosures are forwarded from tier to tier up to the non-federal award. Suppliers must file all certifications and disclosures required by, and otherwise comply with, the Byrd Anti-Lobbying Amendment (31 U.S.C. § 1352).

H. RECORD RETENTION REQUIREMENTS. To the extent applicable, Supplier must comply with the record retention requirements detailed in 2 C.F.R. § 200.333. The Supplier further certifies that it will retain all records as required by 2 C.F.R. § 200.333 for a period of 3 years after grantees or subgrantees submit final expenditure reports or quarterly or annual financial reports, as applicable, and all other pending matters are closed.

I. ENERGY POLICY AND CONSERVATION ACT COMPLIANCE. To the extent applicable, Supplier must comply with the mandatory standards and policies relating to energy efficiency which are contained in the state energy conservation plan issued in compliance with the Energy Policy and Conservation Act.

J. BUY AMERICAN PROVISIONS COMPLIANCE. To the extent applicable, Supplier must comply with all applicable provisions of the Buy American Act. Purchases made in accordance with the Buy American Act must follow the applicable procurement rules calling for free and open competition.

K. ACCESS TO RECORDS (2 C.F.R. § 200.336). Supplier agrees that duly authorized representatives of a federal agency must have access to any books, documents, papers and records of Supplier that are directly pertinent to Supplier's discharge of its obligations under this Contract for the purpose of making audits, examinations, excerpts, and transcriptions. The right also includes timely and reasonable access to Supplier's personnel for the purpose of interview and discussion relating to such documents.

L. PROCUREMENT OF RECOVERED MATERIALS (2 C.F.R. § 200.322). A non-federal entity that is a state agency or agency of a political subdivision of a state and its contractors must comply with Section 6002 of the Solid Waste Disposal Act, as amended by the Resource Conservation and Recovery Act. The requirements of Section 6002 include procuring only items designated in guidelines of the Environmental Protection Agency (EPA) at 40 C.F.R. § 247 that contain the highest percentage of recovered materials practicable, consistent with maintaining a satisfactory level of competition, where the purchase price of the item exceeds \$10,000 or the value of the quantity acquired during the preceding fiscal year exceeded \$10,000; procuring solid waste management services in a manner that maximizes energy and resource recovery;

and establishing an affirmative procurement program for procurement of recovered materials identified in the EPA guidelines.

M. FEDERAL SEAL(S), LOGOS, AND FLAGS. The Supplier cannot use the seal(s), logos, crests, or reproductions of flags or likenesses of Federal agency officials without specific pre-approval.

N. NO OBLIGATION BY FEDERAL GOVERNMENT. The U.S. federal government is not a party to this Contract or any purchase by a Participating Entity and is not subject to any obligations or liabilities to the Participating Entity, Supplier, or any other party pertaining to any matter resulting from the Contract or any purchase by an authorized user.

O. PROGRAM FRAUD AND FALSE OR FRAUDULENT STATEMENTS OR RELATED ACTS. The Contractor acknowledges that 31 U.S.C. 38 (Administrative Remedies for False Claims and Statements) applies to the Supplier's actions pertaining to this Contract or any purchase by a Participating Entity.

P. FEDERAL DEBT. The Supplier certifies that it is non-delinquent in its repayment of any federal debt. Examples of relevant debt include delinquent payroll and other taxes, audit disallowance, and benefit overpayments.

Q. CONFLICTS OF INTEREST. The Supplier must notify the U.S. Office of General Services, Sourcewell, and Participating Entity as soon as possible if this Contract or any aspect related to the anticipated work under this Contract raises an actual or potential conflict of interest (as described in 2 C.F.R. Part 200). The Supplier must explain the actual or potential conflict in writing in sufficient detail so that the U.S. Office of General Services, Sourcewell, and Participating Entity are able to assess the actual or potential conflict; and provide any additional information as necessary or requested.

R. U.S. EXECUTIVE ORDER 13224. The Supplier, and its subcontractors, must comply with U.S. Executive Order 13224 and U.S. Laws that prohibit transactions with and provision of resources and support to individuals and organizations associated with terrorism.

S. PROHIBITION ON CERTAIN TELECOMMUNICATIONS AND VIDEO SURVEILLANCE SERVICES OR EQUIPMENT. To the extent applicable, Supplier certifies that during the term of this Contract it will comply with applicable requirements of 2 C.F.R. § 200.216.

T. DOMESTIC PREFERENCES FOR PROCUREMENTS. To the extent applicable, Supplier certifies that during the term of this Contract will comply with applicable requirements of 2 C.F.R. § 200.322.

22. CANCELLATION

Sourcewell or Supplier may cancel this Contract at any time, with or without cause, upon 60 days' written notice to the other party. However, Sourcewell may cancel this Contract immediately upon discovery of a material defect in any certification made in Supplier's Proposal. Cancellation of this Contract does not relieve either party of financial, product, or service obligations incurred or accrued prior to cancellation.

Sourcewell

CNH Industrial America LLC

DocuSigned by:
Jeremy Schwartz
By: C0FD2A139D06489...
Jeremy Schwartz
Title: Chief Procurement Officer

Date: 4/4/2023 | 2:29 PM CDT

DocuSigned by:
Amy Swett
By: 7FCB6D1BF7F04C0...
Amy Swett
Title: Government & Fleet Sales Account
Manager—New Holland CE brand

Date: 4/4/2023 | 2:31 PM CDT

Approved:
DocuSigned by:
Chad Coauette
By: 7E42B8F817A64CC...
Chad Coauette
Title: Executive Director/CEO

Date: 4/4/2023 | 2:39 PM CDT

RFP 011723 - Heavy Construction Equipment with Related Attachments and Technology

Vendor Details

Company Name: CNH Industrial America LLC
700 State Street
Address: Racine, WI 53404
Contact: Clint Jenkins
Email: Clinton.jenkins@caseih.com
Phone: 937-218-1701
Fax: 877-764-1369
HST#: 760433811

Submission Details

Created On: Wednesday November 16, 2022 13:07:37
Submitted On: Tuesday January 17, 2023 12:55:10
Submitted By: Amy Swett
Email: amy.swett@newholland.com
Transaction #: a0423bfd-2f16-47ee-b66d-446ac499cd78
Submitter's IP Address: 159.61.192.15

Specifications

Table 1: Proposer Identity & Authorized Representatives

General Instructions (applies to all Tables) Sourcewell prefers a brief but thorough response to each question. Do not merely attach additional documents to your response without also providing a substantive response. Do not leave answers blank; respond "N/A" if the question does not apply to you (preferably with an explanation).

Line Item	Question	Response *
1	Proposer Legal Name (one legal entity only): (In the event of award, will execute the resulting contract as "Supplier")	CNH Industrial America LLC
2	Identify all subsidiary entities of the Proposer whose equipment, products, or services are included in the Proposal.	CNH America LLC
3	Identify all applicable assumed names or DBA names of the Proposer or Proposer's subsidiaries in Line 1 or Line 2 above.	CNH Industrial America LLC does not have any assumed names or DBA.
4	Provide your CAGE code or Unique Entity Identifier (SAM):	10988
5	Proposer Physical Address:	700 State Street Racine, Wisconsin 53402
6	Proposer website address (or addresses):	https://www.cnhindustrial.com https://www.casece.com https://construction.newholland.com www.newholland.com
7	Proposer's Authorized Representative (name, title, address, email address & phone) (The representative must have authority to sign the "Proposer's Assurance of Compliance" on behalf of the Proposer and, in the event of award, will be expected to execute the resulting contract):	Amy Swett Government & Fleet Sales Account Manager – New Holland CE brand 500 Diller Avenue New Holland, PA 17557 Amy.swett@newholland.com 717-715-2489
8	Proposer's primary contact for this proposal (name, title, address, email address & phone):	Amy Swett Government & Fleet Sales Account Manager – New Holland CE brand 500 Diller Avenue New Holland, PA 17557 Amy.swett@newholland.com 717-715-2489
9	Proposer's other contacts for this proposal, if any (name, title, address, email address & phone):	Tony Simpson Government Affairs 6021 State Street Racine, WI 53142 262-631-0881 tony.simpson@cnhind.com

Table 2: Company Information and Financial Strength

Line Item	Question	Response *
10	Provide a brief history of your company, including your company's core values, business philosophy, and industry longevity related to the requested equipment, products or services.	<p>The origins of Case date to 1842, when Jerome Increase Case (born in 1819) created Racine Threshing Machine Works in Racine, Wisconsin. The company produced its first portable steam engine in 1876, which is now on display at the Smithsonian Institution.</p> <p>In 1957 Case made the 320 Construction King backhoe loader. Since 1969 Case has manufactured skid steers, starting in Burlington, Iowa and later moving production to Wichita.</p> <p>The company evolved into the Case Corporation, which merged with New Holland in 1999 to become CNH Global which in 2011 became CNH Industrial.</p>

2005: Case made its 500,000th backhoe loader and in 2010 made its 250,000th skid steer loader.

2016: Case released the new G-Series wheel loader lineup consisting of seven new models from 521G thru 1121G.

2017: In its 175th year in business, Case announced its facility in Wichita produced its 300,000th skid-steer loader.

2017: At Conexpo-Con/Agg 2017 Case released the CX750D excavator.

As of May 2017, Case "sells a full line of construction equipment around the world, including the number one loader/backhoes, excavators, motor graders, wheel loaders, vibratory compaction rollers, crawler dozers, skid steers, compact track loaders and rough-terrain forklifts.

New Holland Construction was founded in 1895 in New Holland, Pennsylvania; in 1966 New Holland's first backhoe loader was introduced; in 2005 New Holland Construction Brand was created with a global full-line product offering of Skid steer loaders, compact track loaders, tractor loader backhoes, tractor loaders, wheel loaders and excavators. Since 1999, New Holland is a brand of CNH, which was demerged from Fiat Group to Fiat Industrial at the start of 2011.

2007 New Holland made 200,000 Skid Steer loaders and celebrated 35 years of designing and building its highly successful skid steer loader. They are the preferred choice of landscapers around the world and #1 in lift and carry compact machines.

2008 New Holland's "green" engine. New Holland launched the E215B crawler excavator, which mounts a brand-new engine which dramatically reduces emissions well below the levels required by regulations.

New Holland equipment is built all around the world; the headquarters is in Turin, Italy and with ten plants and ten research and development centers spread globally, more than 800 dealers and 2,100 outlets. It is present in 100 countries worldwide.

New Holland produces thirteen product families, five in the heavy range and eight in the light range; products include dozers, mini excavators, graders, wheel loaders, crawler excavators, backhoe loaders, skid steer loaders.

Productivity, safety, and environmental responsibility are the cornerstones of New Holland's offering built around our customers. We are a key player in the global construction equipment industry born of the rich heritage of brands that made the history of this sector.

In partnership with our worldwide network of dealers, we deliver products and services that meet our customers' requirements for productivity, safety, environmental performance, and fuel and cost efficiency. We know our customers' business and we provide them with a full line of innovative products and services designed for the specific applications of their industry.

CNH Industrial is committed to delivering the highest ethical standards and supporting its dealers and customers through a diverse and inclusive workforce, industry-leading technology, exceptional safety and quality, and unmatched innovation.

At CNH Industrial, we pride ourselves on delivering the best. That means strengthening our product portfolio with dedicated financing, tools and components and selecting the best partners to support us in delivering value to our customers.

We are proud of the work we do at CNH Industrial, where a focus on innovation has helped us to maintain our competitive edge and our position of global leadership.

In 2014 we have a new licensing agreement with Sumitomo Construction Machinery to manufacture Sumitomo designed crawler excavators from 13 to 35 tons. In 2016 we entered an exclusive mini-excavator alliance with Hyundai Heavy Industries.

The full integration of environmental and social considerations with economic objectives enables the Group to identify potential risks and seize additional development opportunities, resulting in a process of continuous, and sustainable, improvement that creates value over the long-term. We recognize the real importance of promoting a circular product life cycle in which resources are used fully and for as long as possible, and products and materials are recovered and regenerated at the end of their service life. For this reason, the Company offers a range of products able to run on fuels derived from renewable sources and is committed to adopting sustainability criteria from the design stage to develop more environmentally friendly products. To maximize product life, CNH Industrial also offers

its customers a range of remanufactured spare parts, in line with its circular economy approach. In manufacturing processes, emphasis is given to improvements that increase waste recovery and reuse.

Living and working in cooperation with the surrounding area, and collaborating on projects that benefit the community, contribute to enhancing the satisfaction of employees (who often live close to plants) and their sense of belonging to the Company, while bringing economic advantages to both the Company and the community. Projects are measured in three fundamental areas. These areas are: Improving food availability, combating climate change & reducing environmental impact and supporting youth training.

A key priority at CNH Industrial is to improve food availability. In the USA, CNH Industrial supports the FFA (formerly known as Future Farmers of America), an association active in farming education since 1928. In 2018, to further its commitment, the Company chartered its own FFA Alumni and Supporters Chapter1, through which employees can engage with students pursuing agriculture degrees and with members of other FFA Chapters nationwide. In 2021, the Company continued to be heavily involved with the FFA. Case IH, New Holland Agriculture, and CNH Industrial Capital continued their Silver Sponsorship of the National FFA Foundation, including its national convention with over 60,000 attendees. Furthermore, employees continued to engage with FFA students at professional development events, and again raised funds towards the purchase of approximately 70 FFA uniforms for students in need.

CNH Industrial also continued its We Care We Share outreach program, holding an educational event at the Thai Sa Kaeo College of Agriculture and Technology aimed at raising agricultural technology standards in the country while creating a new generation of agricultural experts.

In 2021, given the ongoing pandemic, CNH Industrial continued to support more vulnerable sections of society, including through food where needed. Located near the Company's sites in Racine (USA), the Hunger Task Force Farm yields over 226,000 kilos of fresh produce each harvest season to feed the hungry and create a reliable source of healthy food for its network of food banks. In 2017, the farm added a New Holland Agriculture tractor (donated by CNH Industrial Capital) to its operation. In 2021, the Company made a cash donation to the organization to purchase Thanksgiving turkeys for community members in need, while employees provided additional support by volunteering on the farm.

A key priority at CNH Industrial is to combat climate change, whose negative impact on ecosystems affects the quality of life for people in local communities and consumer choices. The Company has initiated several projects to tackle this global issue, which are also aligned with SDG 13 'Climate Action'. These projects are increasingly focusing on reducing the environmental impact of Company plants, including on local communities, and on helping protect the latter against the effects of climate change such as desertification, water scarcity, and the loss of biodiversity. Other initiatives are in place to promote responsible behavior to minimize environmental impact. Participation in the projects associated with this key priority allows CNH Industrial's brands to enhance their profile and increase their visibility among potential customers and strengthens Company employees' sense of belonging.

At CNH Industrial, a key priority is to engage local communities. To this end, and in line with stakeholders' expectations, the Company prioritizes initiatives that support local community development, especially youth training. In addition to the awards and scholarships given to employees' children, the Company works hard to promote young people's education by collaborating with private and public institutions and other stakeholders. Projects are also aligned with SDG 10 'Reduce inequality within and among countries', as they promote training in Emerging Markets with the aim of developing qualified potential recruits for the Company's sales and service networks.

TechPro2, a joint project with schools run by the Don Bosco Salesian Society, aims at training mechatronics specialists to meet a growing demand for skilled personnel, thus offering young people greater employment opportunities – especially within the Company's sales and service network. Training includes theory and hands-on learning at Salesian centers, followed by targeted internships in the field. The goal of TechPro2 is two-fold: on the one hand, to ensure students have a future vocation; on the other, to enhance the quality of specialized technical assistance for the brands' products while meeting the demand for qualified technicians at authorized dealers and workshops. The Company provides expertise by training the teachers, who pass on the knowledge to the classroom students. It also offers financial aid, tools, and essential parts (such as complementary vehicles, engines, drives, and diagnostic tools) for classroom training and practice.

CNH Industrial believes that operating in a socially responsible and ethical manner,

		<p>and in compliance with the laws of the countries in which it operates, is crucial to its long-term success. The Company's Code of Conduct summarizes its policies on various compliance and ethics issues (such as conflicts of interest, corruption, competition, and health and safety). Such policies reflect, among other things, the Company's commitment to adopting fair employment practices, ensuring safety in the workplace, supporting, and fostering environmental awareness, and respecting the communities in which it operates, in compliance with applicable laws. The Company is also committed to the creation of long-term sustainable value for all its stakeholders and is firmly convinced that respect for fundamental human rights and for basic working conditions is a prerequisite to achieving this. The Board of Directors is responsible for creating a culture that fosters such long-term value creation – a task that requires compliance with all applicable laws. To this end, and to clarify and make explicit the Company's values and expectations, the Board has adopted both a Code of Conduct and a Supplier Code of Conduct.</p> <p>Our vast network of CNHi dealers will provide local product technical support at the dealership or out on the road to the members along with providing the start-up and operations training compliant with OSHA regulations, which the members need to get to receive the max. performance and efficiencies out of their products. The customers can also purchase OEM parts from our dealer network to support the members and to ensure their equipment obtains the max. amount of run time. Our financial services to the members include leasing options and extended warranties which are handled directly at the dealership. Members who are on a budget can rent or demo equipment from the dealership. The equipment will be a unit that has not been retailed and comes with full warranty (less than 250 hrs) or pro-rated warranty (if the unit has over 250 hrs). The customer will receive the member list discount and demo/lease adjustment based on rent for sale program rates less any service or clean up fees dealer would have incurred.</p>
11	What are your company's expectations in the event of an award?	<p>When CNH Industrial is awarded the Sourcewell contract, we expect to continue to achieve an overall sales growth of over 10%. Throughout the pandemic and component parts not reaching our plants in a timely manner, we still saw growth in our Sourcewell contract. We plan to continue this growth cycle in 2023. CNH Industrial announce a culture transformation where everyone's voice will be heard. We have five new beliefs Customer first, grow together, one team, make it simple, be the best. This is exactly what we are planning to do with this contract. We want our customers to walk into our dealerships and be heard. Get the product they want and make it an effortless process with Sourcewell. We will continue to partner with Government Solutions Team (GST) where we have done more training in 2022 and plan to continue to follow that process in 2023. Their training includes web training, ride-a-longs to help educate the sales teams and the customers in addition to training new or re-train dealers within their first 60 days. Additional emphasis will go to getting our dealers to attend GTKU's and universities to round out their knowledge of the contract and how to use it to drive the contract's need. We are also going to target and engage with the government entities to get our Sourcewell contract adopted versus these entities having their own contract.</p>
12	Demonstrate your financial strength and stability with meaningful data. This could include such items as financial statements, SEC filings, credit and bond ratings, letters of credit, and detailed reference letters. Upload supporting documents (as applicable) in the document upload section of your response.	<p>CNH Industrial reported strong full year performance in 2021, its final year of operations as a combined Off- and On-Highway entity. We delivered consolidated revenues of \$33.5 billion, up 29% from the previous year. Both our adjusted EBIT from our Industrial Activities at \$2,086 million(1) and our full year Net Income at \$1.8 billion (which translates to \$1.28 in earnings per share) were the highest in our Company's history. Market driven volume and disciplined pricing were key drivers of our record earnings, alongside the team's successful execution, which they achieved while often managing very challenging supply chain and logistics issues. We also recorded another very strong year for positive free cash flow of Industrial Activities(1), at over \$1.8 billion as our operational execution improved. For additional information see our Annual Financial Report 2021</p>
13	What is your US market share for the solutions that you are proposing?	<p>Model Year 2021 CNH Industrial market share 9.5%</p> <p>Case Construction 7.9%</p> <p>New Holland Construction 1.6%</p>
14	What is your Canadian market share for the solutions that you are proposing?	<p>Model Year 2021 CNH Industrial market share 12.6%</p> <p>Case Construction 12.1%</p> <p>New Holland Construction .5%</p>
15	Has your business ever petitioned for bankruptcy protection? If so, explain in detail.	NO

16	<p>How is your organization best described: is it a manufacturer, a distributor/dealer/reseller, or a service provider? Answer whichever question (either a) or b) just below) best applies to your organization.</p> <p>a) If your company is best described as a distributor/dealer/reseller (or similar entity), provide your written authorization to act as a distributor/dealer/reseller for the manufacturer of the products proposed in this RFP. If applicable, is your dealer network independent or company owned?</p> <p>b) If your company is best described as a manufacturer or service provider, describe your relationship with your sales and service force and with your dealer network in delivering the products and services proposed in this RFP. Are these individuals your employees, or the employees of a third party?</p>	<p>CNH Industrial is the manufacturer of the equipment offered in this proposal. Our sales and service force is provided through our network of 1107 North American dealers. Our dealerships are independently owned and operated so they are positioned to provide sales and post support for our customers. Through the post-sale support our dealers offer parts and service. CNH Industrial imposes strict contract regulations and standards (Pinnacle), to hold dealers accountable for all interactions a customer has. This would include sales, service, parts, marketing, and operations.</p>
17	<p>If applicable, provide a detailed explanation outlining the licenses and certifications that are both required to be held, and actually held, by your organization (including third parties and subcontractors that you use) in pursuit of the business contemplated by this RFP.</p>	<p>CNH Industrial adopts the World Class Manufacturing (WCM) management system, a program for innovation based on continuous improvement, developed to eliminate all types of waste and loss through the rigorous application of specific methods and standards (see page 165). Given the customers' demand for ever-higher quality and the level of excellence required by the WCM, the focus is on the quality of every aspect of the manufacturing process, which has led plants to also adopt a quality management system compliant with ISO 9001. As of December 31, 2021, 57 CNH Industrial plants were ISO 9001 certified, collectively accounting for 98% of revenues from sales of products manufactured at the Company's plants¹. To achieve its quality standards, CNH Industrial devised a robust supply chain management process (see page 151) to ensure the procurement of quality components, which are essential to produce vehicles that meet the high standards demanded by customers. CNH INDUSTRIAL completed an initiative, known as Technology Days, gives suppliers a chance to display their innovative products in terms of innovation, technology, and quality, while addressing specific topics and sharing information on recent technological developments. In 2021, the event was as always attended by CNH Industrial employees but held virtually. As of December 31, 2021, 220 supplier plants had adopted the World Class Manufacturing (WCM) program, with no increase compared to 2020 due to pandemic-related restrictions and strategy changes to the WCM supplier program itself. The WCM adoption process entails several activities that take place in two distinct yet equally important phases, and that are meant to provide suppliers with the necessary knowledge to apply the intrinsic concepts of Lean Production. Firstly, various training sessions led by CNH Industrial's WCM program specialists are delivered to suppliers. Secondly, supplier WCM teams are given the opportunity to visit selected CNH Industrial plants to learn about the Company's best practices.</p> <p>Safety is a priority across the Company, as evidenced by the compliance of management systems with the ISO 45001 international standard, as well as with the continuous improvement principles of World Class Manufacturing (WCM) and its specific Safety pillar (see page 165). CNH Industrial's approach to occupational health and safety is based on effective preventive and protective measures, implemented both collectively and individually, aimed at minimizing risk of injury in the workplace. The Company endeavors to ensure optimal working conditions, applying principles of industrial hygiene and ergonomics to managing processes at an organizational and operational level. Additionally, it adopts the highest standards in the countries in which it operates, even where regulatory requirements are less stringent, believing this to be the best way to achieve excellence. In addition, the central Environment, Health, and Safety (EHS) function (which serves as a reference point for sustainability) coordinates and manages health and safety issues as per CNH Industrial's Health and Safety Policy. It periodically verifies performance against targets, proposes new initiatives, and defines health and safety policies. The Company's certification of its occupational health and safety management systems as per the ISO 45001 international standard is voluntary and covers 58 CNH Industrial manufacturing plants worldwide, accounting for 45,521 employees. In 2021, the Company completed its transition to the new ISO 45001:2018 Occupational Health and Safety Management standard, which supersedes the OHSAS 18001:2007 standard. Certifications are awarded by accredited international bodies (in turn continuously and rigorously monitored by other international organizations) that review and certify the high levels of reliability and of operational and procedural standards. In 2021, the occupational health and safety management systems at some non-manufacturing sites were ISO 45001 certified, accounting for 5,684 employees at 12 different sites and locations. In total, 70 CNH Industrial sites worldwide (manufacturing and non-manufacturing) are now ISO 45001 compliant – covering 51,205 employees (about 75.9% of the employees within the reporting scope), 5,388</p>

		<p>contractors, and 7,190 agency workers (representing, respectively, 97% and 91% of the relative populations within the reporting scope) – as are all joint venture plants in which CNH Industrial has at least a 51% interest.</p> <p>World Class Manufacturing (WCM) data (see page 165) relates to 51 plants, representing 99% of revenues from sales of products manufactured at CNH Industrial plants⁴. Occupational health and safety data (see page 82) relates to 66,129 employees, or about 98% of the workforce within the reporting scope. There are 58 ISO 45001 certified plants, accounting for 95% of Company plants and representing approximately 100% of revenues from sales of products manufactured at CNH Industrial plants⁴. Information on environmental performance (including VOC⁵, water, and waste) and management systems (see pages 167; 170) relates to 54 fully consolidated plants, accounting for 89% of Company plants and representing 99.5% of revenues from sales of products manufactured at CNH Industrial plants⁴. There are 58 ISO 14001 certified plants, accounting for 95% of Company plants, representing approximately 100% of revenues from sales of products manufactured at CNH Industrial plants⁴, and relating to 44,682 employees (or about 97% of the workforce at the plants within the reporting scope⁴). Information on energy performance (including CO₂, NO_x, SO_x, and dust emissions) and management systems (see pages 171; 179; 181) relates to 55 fully consolidated plants, accounting for 90% of Company plants and representing 99.7% of revenues from sales of products manufactured at CNH Industrial plants⁴. There are 54 ISO 50001 certified plants, accounting for 89% of Company plants, representing 99.5% of revenues from sales of products manufactured at CNH Industrial plants⁴, and relating to 44,146 employees (or about 95.5% of the workforce at the plants within the reporting scope⁴).</p> <p>Moreover, there are 57 ISO 9001 certified plants, accounting for 93% of Company plants, representing 98% of revenues from sales of products manufactured at CNH Industrial plants⁴, and relating to 44,256 employees (or about 96% of the workforce at the plants within the reporting scope⁴).</p> <p>CNH Industrial also holds its suppliers to a high standard in human resources and sustainability. Please see the attached files for CNH Industrial's Sustainability Plan and Supplier Code of Conduct for more information.</p>
18	Provide all "Suspension or Debarment" information that has applied to your organization during the past ten years.	CNH Industrial has not been Suspended or debarred

Table 3: Industry Recognition & Marketplace Success

Line Item	Question	Response *
19	Describe any relevant industry awards or recognition that your company has received in the past five years	<p>CNH Industrial (NYSE: CNH INDUSTRIAL / MI: CNH INDUSTRIAL) received a 2022 Manufacturing Leadership Award for outstanding achievement in the Sustainability Leadership category, which honors manufacturers that are shaping the future of the sector through digital transformation. This is the third consecutive year that the Company has earned recognition from the Manufacturing Leadership Council, which is a division of the National Association of Manufacturers.</p> <p>CNH Industrial's award-winning project, Smart Pretreatment for the Paint Shop, was executed by the manufacturing team at the Case IH and STEYR agricultural production plant in St. Valentin, Austria. The project enhanced operator safety while ensuring optimum paint quality and sustainable use of additives.</p> <p>The T6 Methane Power also won the prestigious Sustainable Tractor of the Year 2022 award at the EIMA International⁴ trade show held in Bologna (Italy), assigned by a jury panel of top European journalists specializing in farm equipment.</p> <p>Other awards include Innovative Iron for our DL550 Compact Dozer loader in 2022, Top 100 in 2022 for DL550 Compact Dozer loader, TV620B CTL, E. Series Excavators. Top 50 award in 2022 for TV620B CTL. This is just to name a few. Please see entire list in attached documents.</p>

20	What percentage of your sales are to the governmental sector in the past three years	<p>Case Construction -</p> <p>2021 -14%</p> <p>2020 -15%</p> <p>2019 -20%</p> <p>New Holland Construction -</p> <p>2021 - 9%</p> <p>2020 - 10%</p> <p>2019 - 20%</p>
21	What percentage of your sales are to the education sector in the past three years	<p>CNH Industrial Construction brands does not have the capability to pull out the educational percentage, but it is calculated into our sales to the government below.</p>
22	List any state, provincial, or cooperative purchasing contracts that you hold. What is the annual sales volume for each of these contracts over the past three years?	<p>New Holland Construction (CE) Contract Sales</p> <p>Sourcewell CE Contract</p> <p>2019 \$2,906,112</p> <p>2020 \$2,125,345</p> <p>2021 \$3,851,787</p> <p>Michigan CE contract no sales from 2019-2021</p> <p>Pennsylvania CE</p> <p>2019 <\$200,000</p> <p>2020 <\$300,000</p> <p>2021 < \$400,000</p> <p>Ohio CE</p> <p>2019 \$158,736</p> <p>2020 \$206,926</p> <p>2021 \$98,665</p> <p>Iowa CE</p> <p>2019 \$59,043</p> <p>2020 \$104,200</p> <p>2021 <\$100,000</p> <p>State of Louisiana</p> <p>2019 \$330,000</p> <p>2020 \$0</p> <p>2021 <\$100,000</p> <p>State of Georgia</p> <p>2019 \$0</p> <p>2020 \$170,000</p> <p>2021 <\$100,000</p> <p>NASPO</p> <p>2019 \$303,000</p> <p>2020 \$150,000</p>

		2021 \$351,000 BuyBoard 2019 \$938,000 2020 \$547,000 2021 \$331,000 HGAC – No Activity Case Construction Contract Sales Sourcwell Case Construction contract 2019 \$24,000,000 2020 \$18,000,000 2021 \$11,000,000 State of Michigan Case CE 2020 \$ 176,027 2021 \$ 82,070 2022 \$ 321,663 NASPO Case Construction Contract 2019 \$1,200,000 2020 \$1,600,000 2021 \$2,240,000
23	List any GSA contracts or Standing Offers and Supply Arrangements (SOSA) that you hold. What is the annual sales volume for each of these contracts over the past three years?	CNH Industrial Construction brands do not hold any of these contracts.

Table 4: References/Testimonials

Line Item 24. Supply reference information from three customers who are eligible to be Sourcwell participating entities.

Entity Name *	Contact Name *	Phone Number *	
Erie Water Works	Ann Whipple	814-870-8016	*
State Procurement Standards Analyst, OH	Stephanie Klingler	614-387-1130	*
Central Procurement-Enterprise Sourcing – MI	Yvon Dufour	517-249-0455	*

Table 5: Top Five Government or Education Customers

Line Item 25. Provide a list of your top five government, education, or non-profit customers (entity name is optional), including entity type, the state or province the entity is located in, scope of the project(s), size of transaction(s), and dollar volumes from the past three years.

Entity Name	Entity Type *	State / Province *	Scope of Work *	Size of Transactions *	Dollar Volume Past Three Years *
na	Government	Indiana - IN	Mowing	YR QTY 2019 1 2020 21 2021 11	2019 \$ 112,418 2020 \$3,064,492 2021 \$2,083,958
na	Government	New York - NY	Mowing	YR QTY 2019 25 2020 28 2021 0	2019 \$4,405,899 2020 \$5,039,273 2021 \$ 0
na	Government	BC - British Columbia	Mowing/snow removal	YR QTY 2019 10 2020 6 2021 6	2019 \$1,510,557 2020 \$ 951,797 2021 \$1,353,325
na	Non-Profit	ON - Ontario	Mowing/snow removal	YR QTY 2019 16 2020 0 2021 1	2019 \$3,647,150 2020 \$ 0 2021 \$ 137,142
na	Government	South Carolina - SC	Mowing	YR QTY 2019 19 2020 8 2021 6	2019 \$2,391,487 2020 \$1,064,046 2021 \$ 771,893

Table 6: Ability to Sell and Deliver Service

Describe your company's capability to meet the needs of Sourcwell participating entities across the US and Canada, as applicable. Your response should address in detail at least the following areas: locations of your network of sales and service providers, the number of workers (full-time equivalents) involved in each sector, whether these workers are your direct employees (or employees of a third party), and any overlap between the sales and service functions.

Line Item	Question	Response *
26	Sales force.	CNH Industrial field sales force is comprised of employees of the company as well as third party employees of our dealer network who cover the entire US and Canada. Our Field Sales Force are fully focused on the sale of CNH Industrial through our Dealer Networks to our end user. The New Holland Construction Field Sales team is comprised of 5 Region Sales Directors, 44 Territory Business Managers, 5 Business Sales Specialists, 5 Dealer Development Managers, 8 Regional Product Specialists and 40 Technical and Specialty Field Managers. Case Construction is made up of 3 Regional Sales Directors, 21 Field Sales Specialist, 10 Business Managers, 6 Sale Support Managers, and 2 Product & Application Training Specialist. Each independent CNH Industrial dealer supports its local customer base with its own sales, product support and service personnel.

27	Dealer network or other distribution methods.	<p>Case Construction and New Holland Construction has a dedicated dealer network strategically located across North America, and we are continually looking to see where new locations can be opened. Our dealer locations are fully trained and dedicated to sell and support Case Construction and New Holland Construction products covered in this RFP. Many of the principals, their staff and customers hold positions on their local city, village, township, county boards, school boards and positions within their churches, non-profit camps and Fair Boards and non-profit organizations such as Scouts, 4-H, Ducks Unlimited, etc. The efforts and plans of GST to engage New Holland construction dealers from the top down carries the value of our Sourcwell contract through to these community officials who need to purchase equipment efficiently.</p> <p>Our company supports our dealer network with professional Field Service Managers. Each dealership is staffed with parts and service personnel trained to support the products in their area of responsibility. Our company supports the entire United States, along with Hawaii, Alaska, and Canada. Our dealer service personnel are factory trained as well as have access to "Assist," a technical database that helps technicians quickly diagnosis failures through CNH Industrial technical advisors and fellow dealers. We have further support by the Customer Care contact phone numbers: New Holland Construction 1-888-365-6423 and Case Construction 1-866-542-2736.</p>
28	Service force.	<p>Our Field service force is comprised of employees as well as third party employees of our dealer network that covers the US and Canada. All employees must meet annual service training requirements provided on-site by our company, including our service school and online technical training program. Our Field Service force are fully focused on the service of CNH Industrial through our Dealer Networks to the end user. Each one of our independent dealer supports its local customer base with its own sales, product support and service personnel. We value their position as the local support to the members and provide them with the tools, training and support they need so they are a well- rounded team when it comes to the members.</p>
29	Describe the ordering process. If orders will be handled by distributors, dealers or others, explain the respective roles of the Proposer and others.	<p>CNH Industrial ordering process will be handled by our dealer network. The members will go directly to their local dealership when the PO is approved. Their local dealer will then place the order through the eEquipment program which then is sent to the plant and our Order Management department. From there it will be placed into a production schedule. Dealers can monitor the orders from eEquipment to see when the product will be scheduled and when it will be shipping.</p>
30	Describe in detail the process and procedure of your customer service program, if applicable. Include your response-time capabilities and commitments, as well as any incentives that help your providers meet your stated service goals or promises.	<p>Customer service begins with our dedicated dealer network. Each one of our dealerships is fully trained and supported by CNH Industrial so they are committed to immediately addressing all customer needs. Each one of our brand dealerships is supported by the Corporate Customer Service team, "Assist" and factory training.</p> <p>CNH Industrial interacts with and assists its customers to give them an experience that meets their expectations. The Company's Customer Care departments specialize in developing, managing, and promoting customer service solutions, fostering long-lasting relationships, and satisfying customer needs and expectations. Customers may request information or report an issue via the brands' websites, toll-free numbers, smartphone applications, or via email – 24 hours a day, 7 days a week. Customer Care staff manage the entire process, from initial customer contact to final feedback to the customer, ensuring resolutions in the timeliest manner.</p> <p>New Holland Construction's incentive program is the Dealer Standards Program. CASE Construction Equipment's incentive program is the Partnership Program. These programs are designed to assess dealers and reward best-in-class performance across a wide range of operational and performance criteria.</p> <p>Case Construction provides the Tomahawk Customer Center which has been serving its customers for more than 60 years. Sitting on more than 500 acres in Wisconsin's Northwoods, the CASE Tomahawk Customer Center is a premier year-round demonstration facility and business retreat. Enjoy a fully interactive experience with personalized training, state-of-the-art product demonstrations, hands-on equipment operation, and a healthy dose of our trademark hospitality. Like our company and our dealers, our Tomahawk staff is here to provide you with expert guidance and education to help you make informed operating and maintenance decisions</p>
31	Describe your ability and willingness to provide your products and services to Sourcwell participating entities in the United States.	<p>CNH Industrial has been selling and servicing members in the United States through our Sourcwell contract for 12 years. We offer a full array of Construction products and services through our network of local dealers.</p>

32	Describe your ability and willingness to provide your products and services to Sourcewell participating entities in Canada.	CNH Industrial has been selling and servicing members in Canada through our Sourcewell contract for 12 years. Our company offers a price book series in Canadian dollars. We also offer a full array of Construction products and services through our network of local dealers. Our financing and leasing teams live in Canada. This ensures the members are working within the regulations of the Canadian rules. With the assistance of Sourcewell and Canoe Procurement Group and GST, we are expanding our marketing and training efforts and dealer presence throughout Canada. There is a scheduled webinar with Canoe Procurement Group in March 2023.
33	Identify any geographic areas of the United States or Canada that you will NOT be fully serving through the proposed contract.	CNH Industrial will be serving all locations of the United States and Canada.
34	Identify any Sourcewell participating entity sectors (i.e., government, education, not-for-profit) that you will NOT be fully serving through the proposed contract. Explain in detail. For example, does your company have only a regional presence, or do other cooperative purchasing contracts limit your ability to promote another contract?	CNH Industrial will be serving all Sourcewell and CANOE Procurement Group of Canada members.
35	Define any specific contract requirements or restrictions that would apply to our participating entities in Hawaii and Alaska and in US Territories.	CNH Industrial will service all of Hawaii, Alaska, US, and Canada in all market segments. Shipping and delivery expense calculation method will be used for offshore transactions, Alaska, and Hawaii.

Table 7: Marketing Plan

Line Item	Question	Response *
36	Describe your marketing strategy for promoting this contract opportunity. Upload representative samples of your marketing materials (if applicable) in the document upload section of your response.	<p>We will promote Sourcewell to our sales team and government dealers of over 1,000 to our customers. Our sales teams will attend regional training, webinars or in-person training. They will then help to promote and work through a potential sale through the Sourcewell contract with the local dealership. Our dealers will be trained by CNH Industrial government sales manager or their territory business manager. On-insight training, webinars or phone calls can be completed for training. We also have a partnership with Government Solutions Team for New Holland Construction that will also conduct webinars and on-sight training. We want our dealers to have a vast amount of support and success while being trained on the contract. All training is free to the dealers and goes through our Web University for tracking and awarding the teams for their participation. We work with Sourcewell and Canoe Procurement Group to provide marketing materials to the dealers. This material is also used by the dealers for customer visits, shows and other events where our brands and the contract are being promoted.</p> <p>New Holland Construction is also in the process of updating the Buyer's Guide that promotes our products to our government customers. We list our cooperative contracts at the back of the guide. This guide will be distributed to our dealers which in turn will provide to their customers. I have provided a picture of the back page for reference.</p>
37	Describe your use of technology and digital data (e.g., social media, metadata usage) to enhance marketing effectiveness.	<p>CNH Industrial incorporates several uses of technology, digital data, social media, and data to drive market awareness, target prospective sales, train our teams and customers, and perform community outreach. CNH Industrial has a dedicated website for our products and services. New Holland's website allows prospects to build equipment to their specifications, locate dealers and have direct contact information to each government representative. Case Construction website allows prospective customers to locate dealers. Our social media presence spans from Instagram, Facebook, Twitter and LinkedIn. We follow, like and share Sourcewell media along with other industry leaders to promote a full support system to our teams, dealers, and the community. By doing this, it keeps our brands at the top of our prospects' minds. We also utilize data from the Association of Equipment Manufacturers (AEM) on governmental and non-profit sales. The data shows sales activities and high-density sales areas. This also allows us to understand our effectiveness in the marketplace compared to our competitors.</p> <p>We also have a governmental bid service. By investing in this service it allows for an advantage over our competitors and directs opportunities to the Sourcewell contract. This also allows us to see the future requirements of a member so our dealers can reach out and build a relationship with them and offer the Sourcewell as a solution to their bid process.</p> <p>We also conduct training and post videos online to reach a maximum audience and to keep our teams "in the know" as soon as possible. We want to get the information out quickly, so our members have the most current information. New Holland Construction government sales managers along with GST work with our teams daily through these trainings, videos, and emails to help them understand their market and the opportunities that exist.</p>

38	In your view, what is Sourcewell's role in promoting contracts arising out of this RFP? How will you integrate a Sourcewell-awarded contract into your sales process?	<p>We expect Sourcewell to promote the contract through social media, digital media, shows and events. Also, to allow members to easily locate our contracts on the landing page on Sourcewell's website and keep the member's list current. Communicating how the contracts are adopted and by whom is another significant role Sourcewell can provide. The H20 conference is an excellent tool where vendors can come together and share lessons learned, wins and best practices. When members contact Sourcewell, we expect them to directly thank them, answer any questions they have, and provide our contract information to the members. We would like our contract manager to follow up with an email or call to us on who called and their contact information and what was needed. This will allow us to continue the sales process by reaching out to them and showing them, we have a team with Sourcewell and CNH Industrial.</p> <p>We will continue to train our Territory Business Managers and dealers at our sectional and regional CNH dealer and sales meetings on this contract. We will continue to educate our dealers through webinars, phone calls and in-person training. When the contract is awarded, we will be sending out a letter with the new matrix to our dealers letting them know of the newly awarded contract. New Holland Construction will also be utilizing the GST team to train our members on the contract. They have a novel approach on touch points with the dealers during training. Our dealers are notified in several diverse ways through mail, email, and phone calls which then leads up to training. The focus does not stop after the training. GST continues to contact them after that process, so we do not lose touch with them. GST provides our dealers with a listing of Sourcewell members located in their area.</p> <p>This contract is particularly important to each one of our brands and is highly expressed to our CNH Industrial employees and dealers. Therefore, we have continued to grow the contract even through the Covid period. We plan to stay the course and continue with our message to our employees and dealers which is, "you should not have to bid for low dollars or a product you do not want, use Sourcewell and get what you deserve."</p>
39	Are your products or services available through an e-procurement ordering process? If so, describe your e-procurement system and how governmental and educational customers have used it.	<p>Not now. Our contract is awarded through our dealer level, and this places too many variables. We have had conversations with NASPO to see if there is a way to work on an industry standard. Some of the states have already started going to the e-procurement system but with our highly configured products, it is difficult to work within their perimeters. We are willing to work with Sourcewell and the team you have put together to produce a process for e-procurement, whether this be through an EDI system or finding a company that has already created a process.</p>

Table 8: Value-Added Attributes

Line Item	Question	Response *
40	Describe any product, equipment, maintenance, or operator training programs that you offer to Sourcewell participating entities. Include details, such as whether training is standard or optional, who provides training, and any costs that apply.	<p>We hold product training and customer experience events throughout the year. Any dealer current customer or potential customer can attend these events.</p> <p>At the corporate training facilities or the servicing dealer level, Operator and Maintenance training can be specifically structured for the customer. The servicing dealer provides base machine operation and maintenance training as part of the purchase and delivery. Additional training can be purchased through the local dealership.</p>

41	Describe any technological advances that your proposed products or services offer.	<p>New Holland Construction has announced the E15X first electric vehicle which has no air or sound pollution.</p> <p>New Holland Construction included an 8" LCD Multifunction Display in the 300 Series Skid Steer Loader and Compact Track Loader products. This brings the operator input and functionality to another level over what we had in the past. Particularly, the addition of a factory fit reverse camera, and improved EZ EH control adjustability.</p> <p>Meet the CASE Minotaur™ DL550 — an all-new, industry-first equipment category: the compact dozer loader. The integrated C-frame delivers true dozer performance and the agility and finesse of a loader. CASE Construction Universal Machine Control allows you to use the precision construction technology you prefer*. It's compatible with hundreds of attachments, and the addition of an industry-exclusive fully integrated ripper makes this machine one-of-a-kind. It has the strength, attitude and intelligence to stake a claim as the industry's most versatile and powerful compact machine.</p> <p>Minotaur demonstrates CASE Construction's commitment to delivering real-world innovation rooted in customer need. With 29 patents**, more than 10,000 field test hours, multiple customer clinics, countless operator evaluations, product refinements and even more evaluations after that — we've put this machine to the test to deliver you the highest standard in quality.</p> <p>THE INDUSTRY'S FIRST FULLY ELECTRIC BACKHOE LOADER — THE CASE 580 EV</p> <p>The CASE 580 EV (electric vehicle) delivers backhoe power and performance equivalent to its diesel counterpart while also providing instant torque, lower jobsite noise, lower daily and lifetime operating costs, reduced maintenance demands and absolutely zero emissions. This will be anticipated to launch in 2024.</p> <p>The CASE 580 EV Delivers Ultimate Power and Sustainability</p> <ul style="list-style-type: none"> - Zero Emissions: Lower your carbon footprint and achieve incentives/greater consideration for new projects with electrified additions to your fleet. - All the Performance: The battery separately powers the drivetrain and hydraulic motors, resulting in hydraulic breakout forces equal to diesel-powered machines and improved performance during simultaneous loader and drivetrain operation. - Long-Lasting Power: The machine's lithium-ion battery provides enough power for the typical 8-hour workday. - Lower Operating Costs: Save as much as 90 percent in annual vehicle, fuel, and maintenance costs. - Classic CASE Performance: The 580 EV retains the precision and efficiency of diesel-powered CASE backhoes with features such as ProControl, which allows for extremely precise boom movement and placement, as well as Comfort Steer, which significantly improves steering while working in tight quarters or in truck loading operations. <p>The CASE CX15 EV (Electric Vehicle) is a 2,900-pound mini excavator powered by a 16-kW electric motor — it features retractable tracks that get machine width down to about 31 inches for going through doors and working in confined spaces. It can also work close to structures and obstacles with a minimum swing radius design. The 21.5 kWh lithium-ion battery is charged either by the 110V/220V on-board charger, or via an external rapid charger that can have the machine charged extremely fast, typically within 90 minutes. Depending on the type of work, unit will provide enough power to work through a full eight-hour workday.</p>
42	Describe any "green" initiatives that relate to your company or to your products or services, and include a list of the certifying agency for each.	<p>In compliance with its Environmental Policy, CNH Industrial is committed to minimizing the environmental impact of its ICT activities by using energy-efficient products and solutions. Indeed, the Company implemented the Green ICT plan precisely to reduce energy consumption and CO2 emissions. In 2021, approximately 8,200 personal computers and 1,083 technical workstations were replaced with new equipment featuring more efficient power supply units, optimizing the consumption of electricity drawn from the grid. The Company also replaced around 1,100 computer monitors with new units that comply with environmental requirements regarding product energy consumption and efficiency, the use of hazardous substances, recyclability, packaging materials, and low-impact manufacturing methods.</p> <p>Within the scope of Brands4Sustainability3, CNH Industrial supported a project called Capri Circolare - A Sustainable Tourism Model, an in-depth analysis of potential areas of intervention to position the island of Capri at the forefront of environmental sustainability. The goal is to turn Capri into a green destination by developing a model that promotes a circular economy and the implementation of good practices to protect the local region, resources, and biodiversity. In Córdoba (Argentina), IVECO created an Ecological Island where carpenters use recycled materials to make parts that are then used in various plant production and logistics processes. In broad terms, the company applied the 5Rs of waste management (refuse, reduce, reuse, recycle, recover) to enable the reuse of approximately 4,800 kilos of reclaimed wood and around 3,600 kilos of corrugated plastic per year. The Company also contributed to creating policies in support of alternative fuels — and a circular economy — in the agriculture sector, particularly promoting the use of biomethane and Agriculture 4.0 programs through specific initiatives in many countries. As a long-</p>

standing member of the European Automobile Manufacturers' Association (ACEA), while also holding a seat on its board, the Company has actively contributed to the debate on EU (European Union) policies to lower CO2 emissions and achieve net-zero emissions in the future. Moreover, with a seat on the association's Commercial Vehicles Board, IVECO actively contributed to the discussions on how manufacturers can help achieve the EU's 2050 Greenhouse Gas Emissions (GHG) goal, highlighting the role that both liquid and gas renewable fuels can play in the transition towards net-zero CO2 emissions in transport. As regards light-duty vehicles, IVECO is actively involved in the ongoing discussions and advocacy activities regarding the revision of the post-2020 CO2 emission standard for cars and vans.

CNH Industrial is also a member of the Committee for European Construction Equipment (CECE) and of the European Agricultural Machinery Association (CEMA), trade associations for construction equipment and agricultural machinery manufacturers, respectively. Throughout 2021, the Company collaborated with the associations' committees and project teams to bring forward EU legislation on the safety and environmental aspects of off-road machinery. Following the European Green Deal plan presented by the European Commission, CNH Industrial contributed to further discussions within CECE's and CEMA's High-Level Groups on CO2 concerning ways to reduce GHG emissions and decarbonize both the agriculture and construction sectors in Europe.

CNH Industrial is also a board member of the European Association of Internal Combustion Engine Manufacturers (EUROMOT). In 2021, particularly through its brand FPT Industrial, the Company contributed to the association's activities centered on Non-Road Mobile Machinery (NRMM) exhaust emissions, proposing the creation of a new working group within the association focused on alternative powertrains and advanced energy resources. The aim was to further promote alternative and more sustainable powertrain solutions within non-road sectors as well (such as marine applications or mobile equipment) considering the EU's most recent sustainability and climate goals. The Company holds a seat on the board of the Natural & biogas Vehicle Association (NGVA Europe), which advocates and fosters the use of natural gas and biomethane for transport in Europe. In 2021, in collaboration with several other national associations for natural gas, IVECO and FPT Industrial promoted debate in Europe on natural gas strategy (considering the EU's targets for 2030 and beyond) and its advancement in Europe, in line with EU legislation on the development of natural gas infrastructures.

CNH Industrial is member of the board of Hydrogen Europe, representing the hydrogen and fuel cell industry, national associations, and research centers in Europe, and of the Hydrogen Council, a global initiative among leading energy, transport, and industry enterprises that focuses on the contribution and potential of hydrogen in the transport sector while contributing to policymaking and the ongoing debate, working towards the future commercialization of fuel cell vehicles. In this regard, the Company also participates in the European Clean Hydrogen Alliance, an initiative by the European Commission and Hydrogen Europe that brings investors together with governmental, institutional, and industrial partners, aimed at steering and coordinating the ambitious plan to deploy hydrogen technologies by 2030, and at rapidly upscaling clean hydrogen production and use in Europe.

New Holland Agriculture was one of the main stakeholders at the event Seeding the Future of Sustainable Farming: Advanced Farm Machines & Solutions to Deliver on the European Green Deal, a summit organized by the European Agricultural Machinery Association (CEMA) in Brussels (Belgium). The focus was on how digital farming tools, modern farm machines, and farm data management systems will drive the European agriculture sector in taking on the double challenge of producing sufficient quality food and safeguarding biodiversity.

The importance of sustainable planning to the Company lies not only in time and cost efficiencies, but also in emissions reduction, resource use, packaging management, and, not least, in their indirect impact on human health and traffic congestion. To coordinate its efforts effectively towards improvements in this area, CNH Industrial published its Green Logistics Principles, available on the Company's website; intended to coordinate the Company's initiatives on promoting sustainable behaviors, they help both corporate functions and suppliers effectively monitor their performance and meet improvement targets.

In North America, the Agriculture and Construction segments continued to engage their logistics partners in the SmartWay transport program. Launched in 2003, the program is sponsored by the Environmental Protection Agency (EPA) to improve efficiency, reduce greenhouse gas, and air pollutant emissions along the transport chain. SmartWay provides its partners with a set of EPA-tested tools that help make informed transportation choices, measure, and report CO2 emissions, and improve supply chain efficiency and environmental performance.

More information can be found on our 2021 Sustainability Report

43	Identify any third-party issued eco-labels, ratings or certifications that your company has received for the equipment or products included in your Proposal related to energy efficiency or conservation, life-cycle design (cradle-to-cradle), or other green/sustainability factors.	<p>Several CNH Industrial plants continued to implement initiatives to reduce packaging waste, according to the 5 Rs11 of waste management (in particular, the Reuse principle). Improvement measures involved several plants, including New Holland (USA), Annonay (France), Zedelgem (Belgium), Córdoba (Argentina), and Curitiba, Piracicaba, and Sorocaba (Brazil), reducing overall packaging waste by more than 1,000 tons and saving approximately \$650,000. As per existing guidelines on packaging-waste compactors, aimed at mitigating the environmental impact and management costs associated with waste, CNH Industrial plants continued to reduce the volume of stored waste, thus requiring less frequent collection and disposal services by third-party providers. For example, the plant in Rorthais (France) installed a cardboard compactor, saving over \$9,200.</p> <p>New Holland Agriculture was one of the main stakeholders at the event Seeding the Future of Sustainable Farming: Advanced Farm Machines & Solutions to Deliver on the European Green Deal, a summit organized by the European Agricultural Machinery Association (CEMA) in Brussels (Belgium). The focus was on how digital farming tools, modern farm machines, and farm data management systems will drive the European agriculture sector to take on the double challenge of producing sufficient quality food and safeguarding biodiversity.</p> <p>See all the green initiatives stated on #43. We continue to support conservation efforts with third parties.</p>
44	Describe any Women or Minority Business Entity (WMBE), Small Business Entity (SBE), or veteran owned business certifications that your company or hub partners have obtained. Upload documentation of certification (as applicable) in the document upload section of your response.	<p>CNH Industrial is proud to partner with Small Business, Veteran Owned, Women or Minority Owned, Native American Owned and other Disadvantaged Business Enterprises.</p> <p>Monroe Tractor 1001 Lehigh Station Road, Henrietta, NY 14667 – WBE Certified noted on website www.monroetractor.com</p> <p>Yukon Equipment in AK is Native Owned. It was established under the Alaska Native Claims Settlement Act of 1971. https://yukoneq.com/about-us/</p>
45	What unique attributes does your company, your products, or your services offer to Sourcwell participating entities? What makes your proposed solutions unique in your industry as it applies to Sourcwell participating entities?	<p>We are dedicated to our Clean Energy Leader® strategy, launched in 2006, which promotes the use of renewable fuels, systems to reduce emissions, technological tools, and sustainable agricultural practices. We recognize today as a global leader in powerful, reliable, and highly efficient equipment that helps our members meet the challenges of modern-day tasks. We have numerous models in several product lines which speak to understanding member needs and proving them with the correct solution. This is accomplished by our strong dealer network and our field teams working together to help our members define their needs. Our dealers are measured on technical, financial and sales performance levels and maintain certifications to back up these performance levels. Our focus is to align with what our members' needs are while controlling costs. We also have our unique demo/rental program available to members under this proposal. A member can use the product in advance and receive additional discounts if they choose to purchase the equipment. This allows the member to make sure they are getting the right product for the job. New Holland Construction partnership with Government Solutions Team (GST) will continue to have an impact on the members through the education and speaking opportunities they are afforded during our meetings and events as well as during events taking place at all levels throughout North America which they are invited to attend. Their vast array of knowledge and experience working with members in this sector compliments our team in the field with getting the Sourcwell contract utilized and talked about. Their ability to speak to the members as a third party has been of great value in successfully helping members understand how to utilize the contract.</p>

Table 9: Warranty

Describe in detail your manufacturer warranty program, including conditions and requirements to qualify, claims procedure, and overall structure. You may upload representative samples of your warranty materials (if applicable) in the document upload section of your response in addition to responding to the questions below.

Line Item	Question	Response *
46	Do your warranties cover all products, parts, and labor?	New Holland Construction and Case Construction covers all products, parts and labor. This is defined in our Warranty and Limitation of Liability agreements for both brands. For Case Construction this is defined in the Dealer Operating guide.

47	Do your warranties impose usage restrictions or other limitations that adversely affect coverage?	<p>Both New Holland Construction and Case Construction have items that are not covered such as:</p> <ul style="list-style-type: none"> • Repairs arising from storage deterioration, failure to maintain the equipment, negligence, alteration, improper use of the equipment, collision or other accident, vandalism, or other casualty, or operation beyond rated capacity or specification. • Repairs arising from abuse or neglect, including but not limited to: operation without adequate coolant or lubricants, adjustments to the fuel system outside equipment specifications, over-speeding, improper storage, starting, warm-up, or shutdown practices, incorrect fuel or contaminated fuel, oil or other fluids. • Normal maintenance services, such as engine tune-ups, engine fuel system cleaning, checks, adjustments, shimming, etc. • Replacement of non-defective wear items expected to be replaced during the warranty period, including but not limited to light bulbs, spark plugs, brake or clutch linings, slip clutches, belts, chains, knives, bucket cutting edges and teeth, crawler track pads and track components, crop processing and cutting components, external drive sprockets and chains, soil engaging tools and accessories. <p>For other items please see the Warranty and Limitation of Liability agreements for both brands.</p>
48	Do your warranties cover the expense of technicians' travel time and mileage to perform warranty repairs?	Case Construction does reimburse on some Heavy Construction products.
49	Are there any geographic regions of the United States or Canada (as applicable) for which you cannot provide a certified technician to perform warranty repairs? How will Sourcewell participating entities in these regions be provided service for warranty repair?	Both New Holland Construction and Case Construction dealer network provide technicians for repair and the network covers the entire of North America.
50	Will you cover warranty service for items made by other manufacturers that are part of your proposal, or are these warranties issues typically passed on to the original equipment manufacturer?	We will cover certain items made by other manufacturers. Certain items are covered by some OEM's such as engines manufactured by Deutz, Kubota, Yanmar, etc. We do not cover warranty for items made by other manufacturers. Coverage detail is provide in the Warranty and Limitation of Liability agreement form which the customer signs at the time of delivery.
51	What are your proposed exchange and return programs and policies?	<p>CNH Industrial's responsibilities include, but are not limited to:</p> <ul style="list-style-type: none"> - Deliver a unit that is free of defects in material and workmanship - Reimburse for costs for repairs that are the result of defects in material and workmanship - Provide warranty payment to dealers per policy in a timely manner - Provide service information to dealers via the Technical Help Desk - Identify product deficiencies and corrective action by Product Improvement Programs - Make determinations of premature wear - Provide operators manuals <p>If for some reason defects/failures arise, CNH Industrial will take corrective action under the warranty policy. Returns/Exchanges are not allowed.</p>
52	Describe any service contract options for the items included in your proposal.	We do provide services under ProCare Program for Heavy Construction equipment; where a customer receives Extended Warranty coverage, and it includes planned maintenance for 3 years & SiteWatch subscriptions.

Table 10: Payment Terms and Financing Options

Line Item	Question	Response *
53	Describe your payment terms and accepted payment methods.	Payment terms are Net 30, after receipt of invoice. Acceptable payment methods would be at the local dealer's discretion, but most would accept cash, ACH, Check and P-Card.
54	Describe any leasing or financing options available for use by educational or governmental entities.	Financing options and leasing solutions are available from CNH Industrial Capital America LLC. Sourcewell members should contact the local CNH brand construction equipment dealer to see what options are available.
55	Describe any standard transaction documents that you propose to use in connection with an awarded contract (order forms, terms and conditions, service level agreements, etc.). Upload a sample of each (as applicable) in the document upload section of your response.	CNH Industrial will administer a matrix that will be published on our Dealer Portal and/or sent to our dealers notifying them of the contract period, products awarded, and discounts off list price so they can quote equipment to members. The sample matrix will be uploaded for your reference. We provide the dealers with a matrix which provides the Sourcewell member with the product, discount off list and pricing available to them.
56	Do you accept the P-card procurement and payment process? If so, is there any additional cost to Sourcewell participating entities for using this process?	Acceptance would be at the local dealer's discretion.

Table 11: Pricing and Delivery

Provide detailed pricing information in the questions that follow below. Keep in mind that reasonable price and product adjustments can be made during the term of an awarded Contract as described in the RFP, the template Contract, and the Sourcewell Price and Product Change Request Form.

Line Item	Question	Response *
57	Describe your pricing model (e.g., line-item discounts or product-category discounts). Provide detailed pricing data (including standard or list pricing and the Sourcewell discounted price) on all of the items that you want Sourcewell to consider as part of your RFP response. If applicable, provide a SKU for each item in your proposal. Upload your pricing materials (if applicable) in the document upload section of your response.	We are offering discounts off the product category. The total purchase price will include a discount off the list with freight, setup, surcharge, and any other extra costs associated with the final sale on separate line items. CNH Industrial Discounts off List price: Skid Steer Loaders 35% Compact Track Loaders 32% New Holland Tractor Loader Backhoe 35% Case CE Tractor Loader Backhoe 37% Tractor Loader 32% Compact Wheel Loader 32% Crawler Excavator 32% Rough Terrain Forklifts 32% Compact Dozer Loader 32% Crawler Dozer 37% Heavy Wheel Loader 37% Heavy Excavator 32% Motor Grader 32% Compaction 32%
58	Quantify the pricing discount represented by the pricing proposal in this response. For example, if the pricing in your response represents a percentage discount from MSRP or list, state the percentage or percentage range.	CNH Industrial discounts are off list price ranging from 32% to 37%.

59	Describe any quantity or volume discounts or rebate programs that you offer.	CNH Industrial does not offer any additional discounts currently. Our local dealers are authorized at their discretion to provide additional discounts.
60	Propose a method of facilitating "sourced" products or related services, which may be referred to as "open market" items or "nonstandard options". For example, you may supply such items "at cost" or "at cost plus a percentage," or you may supply a quote for each such request.	The proposed pricing for sourced equipment or services will be "open market." CNH Industrial will provide a quote for each request. Dealers may provide additional discounts at their discretion on the unit in question.
61	Identify any element of the total cost of acquisition that is NOT included in the pricing submitted with your response. This includes all additional charges associated with a purchase that are not directly identified as freight or shipping charges. For example, list costs for items like pre-delivery inspection, installation, set up, mandatory training, or initial inspection. Identify any parties that impose such costs and their relationship to the Proposer.	Additional cost that maybe associated with each transaction that dealers may include: -Set-up/pre delivery inspection -Surcharges if applicable -additional manuals -freight -training
62	If freight, delivery, or shipping is an additional cost to the Sourcwell participating entity, describe in detail the complete freight, shipping, and delivery program.	Freight, both from manufacturing facilities, distribution points, or transfers from other dealers' inventory will be added as a separate line item. This cost is FOB, but CNH Industrial often subsidizes it to remain competitive in the marketplace.
63	Specifically describe freight, shipping, and delivery terms or programs available for Alaska, Hawaii, Canada, or any offshore delivery.	Shipping and delivery expenses calculation method will be used for offshore delivery as well as Alaska, Hawaii, and Canada.
64	Describe any unique distribution and/or delivery methods or options offered in your proposal.	We do offer the option for equipment to be coded "will call." This allows the customer to pick up the equipment from the manufacturing/distribution points. This can lower the cost of the transaction.

Table 12: Pricing Offered

Line Item	The Pricing Offered in this Proposal is: *	Comments
65	c. better than the Proposer typically offers to GPOs, cooperative procurement organizations, or state purchasing departments.	

Table 13: Audit and Administrative Fee

Line Item	Question	Response *
66	Specifically describe any self-audit process or program that you plan to employ to verify compliance with your proposed Contract with Sourcwell. This process includes ensuring that Sourcwell participating entities obtain the proper pricing, that the Vendor reports all sales under the Contract each quarter, and that the Vendor remits the proper administrative fee to Sourcwell. Provide sufficient detail to support your ability to report quarterly sales to Sourcwell as described in the Contract template.	Our dealers are required to upload documents when they purchase equipment. They will upload the customer's purchase order, dealer's invoice to customer, and authorization letter. Each month Government Sales Manager audits the Sourcwell documents and verifies membership, pricing, discount, etc. Each quarter a report is generated on all Sourcwell sales and sent to the buyer.
67	If you are awarded a contract, provide a few examples of internal metrics that will be tracked to measure whether you are having success with the contract.	Market Share is important to our business. Each month we run reports from AEM to understand our position in the marketplace. This report includes total government sales, and from the percentage of government sales going into Sourcwell is determined. Our goal is to continue to grow this matrix in the percentage of government sales to increase Sourcwell sales. We also are looking at our year over year and quarter-over-quarter results in sales volume dollars. This will show us if we are on target for growth vs that of last year's quarter.
68	Identify a proposed administrative fee that you will pay to Sourcwell for facilitating, managing, and promoting the Sourcwell Contract in the event that you are awarded a Contract. This fee is typically calculated as a percentage of Vendor's sales under the Contract or as a per-unit fee; it is not a line-item addition to the Member's cost of goods. (See the RFP and template Contract for additional details.)	CNH Industrial agrees to continue to pay Sourcwell a 0.75% contract fee. Our contract has continued to grow, which results in profit for all parties involved.

Table 14A: Depth and Breadth of Offered Equipment Products and Services

Line Item	Question	Response *
69	Provide a detailed description of the equipment, products, and services that you are offering in your proposal.	<p>New Holland Construction Equipment: MEET YOUR CHALLENGES HEAD-ON</p> <p>New Holland's ongoing commitment to making the most dependable and innovative construction equipment brings you the 300 Series skid steer loaders. They provide enhanced productivity, comfort and ease, while still delivering outstanding lift and breakout force and rock-solid stability. Customize your machine for your specific demands with a wide array of versatile attachments and options. The patented Super Boom® vertical lift linkage delivers maximum reach at maximum height to allow you to place loads precisely in the center of high-sided truck boxes or hoppers. New Holland Tier 4 Final engines deliver powerful performance, use less fuel and are easy to maintain to decrease your operating costs. The reliable hydraulic system delivers fast cycle times. In-line hydraulic pumps produce less noise and provide extra-smooth operation. Add the optional high-flow hydraulics to run attachments hour after hour. The 300 Series dual-range transmission provides travel speeds of more than 11 mph to save time on and between job sites. It is standard on the L320, L321, L328, and L334. New Holland's long wheelbase gives you stability and smooth riding comfort. A new available creep mode (EH models only) gives you greater control for slow-speed operations like trenching.</p> <p>New Holland's 300 Series loaders make your workday more productive and comfortable with a compact track loader from New Holland. These 60 to 114 gross HP loaders are tough models that deliver incomparable performance and craftsmanship. Whether you are a farmer, contractor, or landscaper, the 300 Series loaders are built to support you and your operation. They hold fast to steep slopes and move easily through muddy or sandy terrain to complete jobs quickly and efficiently.</p> <p>New Holland's D Series loader backhoes represent a huge step forward in operator comfort and productivity while delivering Tier 4 Final emission compliance without compromise. A new cab design featuring 10% more space, new rear side windows, vastly improved clearance when turning the seat for backhoe operation, and hugely improved in-cab storage capacity guarantees an enhanced operator experience and increased operator productivity. Many customers need a loader that offers the versatility to do a lot more than just move bulk material, including grading and leveling as well as grabbing heavy items like tree trunks and concrete pillars. They also need a tractor unit offering the traction and power to push materials into place or out of the way. With a 4-in-1 bucket, a D Series loader backhoe delivers exceptional performance with just a single attachment. Choose a 6-in-1 bucket and you have the option to flip down adjustable pallet forks for handling palletized loads without a dedicated vehicle. The backhoe can be equipped with a wide choice of buckets to match excavation, water-course clearance, trenching and other demands. You can also fit post hole diggers, hydraulically extendable dipper and countless other tools. The long, nearly 23-ft. reach of both the standard and telescopic dipper allows digging depth comparable to many conventional dedicated excavators. Add the new updated cab featuring a new heated seat and up to ten LED lights and exterior side lights on the cab roof, and there are no performance compromises with a New Holland D Series loader backhoe.</p> <p>CLASS-LEADING POWER AT BUCKET AND HITCH</p> <p>The U80D tractor loader from New Holland delivers 74 gross horsepower of clean power with its Tier 4 Final certified engine. You get responsive power at both bucket and hitch, so the U80D pays its way by loading, stacking, scraping and leveling. Add the Glide Ride option, and the boom cylinders become the equivalent of giant shock absorbers to stabilize the load while traveling. The curved-arm loader linkage provided on the U80D tractor loader provides hydraulic bucket leveling for less spillback, as well as excellent reach at maximum dump height for truck loading. The unique reverse-mounted loader arm cylinders give you maximum bucket breakout force and superior dump speed on the bucket. Rugged Class II three-point hitch with controllable down pressure provides excellent scraping and leveling performance. The synchromesh transmission with power shuttle gives you smooth control and easy forward-reverse shuttling.</p> <p>New Holland compact wheel loaders do more than load. With dependable engine and hydraulic power and a choice of buckets and attachments, you can easily scrape, grade, haul and more. Z-Bar linkage design provides maximum breakout force, digging and lifting power for high-production load-and-carry applications. For applications where self-leveling is needed, like forklift work, consider the W50C TC Tool Carrier model. A stable compact design allows you to work and maneuver easily in restricted spaces. A lower machine height and lower center of gravity increases the stability of New Holland compact wheel loaders so you can lift and move larger loads, travel smoothly and quickly, and operate with more confidence.</p>

You can work next to buildings, foundations, and roads with greater confidence in a New Holland Construction C Series compact excavators. They combine power, performance, and versatility to make the very most of every minute of your day. C Series excavators deliver big digging and grading performance with SAE bucket breakout forces up to 8,490 lbf and dig depth up to 12.5 feet. Their compact design and zero/short tail swing mean you can dig, fill, and grade in the most confined, congested areas. You can offset the excavator boom left or right within the operating range to match the situation. The C Series also offers more ground clearance and excellent dozer blade lift height for maneuvering and working in tough conditions. With seven models from 1.7 to 6 tons, there is nothing small about the performance of New Holland compact excavators. All models offer an increase in horsepower compared to previous models, powered by quiet, fuel-efficient Tier 4 Final engines up to 66.9 horsepower. Ease and comfort equate with operator productivity, so the wide C Series cab is designed for spaciousness, all-around visibility, comfortable seating, and smooth control. New Holland's Auto Shift traveling system automatically downshifts when load increases to enhance travel torque on slopes and in difficult conditions, then shifts back up to secure a faster travel speed after the load decreases. The Auto Idle system activates when you are not using the operating levers to improve fuel efficiency.

Case Construction Equipment:

The CASE B Series skid steers build on more than 50 years of engineering and field experience to provide the most intuitive operator experience and comfortable working environment ever built into a CASE skid steer — including an eight-inch LCD multi-function display and simple electro-hydraulic controls. The design simplifies operation and puts more power and control into the hands of the operator. Match that with productivity-enhancing horsepower and torque, powerful auxiliary hydraulics, and industry-leading visibility — and CASE B Series skid steers allow you to get more done every day.

The CASE skid steer lineup features the sizes, lift patterns, power, and emissions solutions to match any application. Five radial-lift and three vertical-lift skid steers across numerous horsepower and size classes ensure that you will find the right solution for your operation. CASE B Series skid steers also provide operators with the most feature-rich operator experience ever found in a CASE skid steer, including electro-hydraulic controls, "Creep Speed" functionality, an automotive-style information display with improved fault codes and troubleshooting, as well as Economy Modes with engine protection. The eight-inch LCD multi-function display serves as the command center for the machine and includes the industry's only backup camera visible in a split screen display with machine data.

The CASE B Series compact track loaders offer a completely re-imagined operator interface and environment to simplify operation and put more power and control into the hands of the operator — including an 8-inch LCD multi-function display and simple electro-hydraulic controls. Match that with industry-leading visibility, productivity-enhancing horsepower and torque, extreme attachment versatility, and lift geometries and size classes to meet every demand — and CASE B Series compact track loaders have the strength and performance to handle your toughest jobs. Jobsite productivity and awareness are driven by industry-leading visibility — further improved with the backup camera and a cab-wide rearview mirror. Operators have the industry's best perspective of the job through large front and side windows, a low entry threshold for greater visibility down to the bucket, a low sloping rear hood and 360-degree lighting.

CASE backhoe loaders – extra power when you want it, precise control where you need it and a sophisticated-yet-simple machine that needs less from you to get more done, more quickly. When your backhoe legacy dates to the world's first fully integrated production backhoe loader, you know they are expected to do everything. So, you engineer them to be stronger and more responsive, roading, loading, or digging. That is the Tier 4 Final N Series backhoe. Give your backhoe a shot in the arm. At the push of a button, Power Boost provides a temporary surge of power – up to 8% more breakout – without decreasing RPMs (Revolutions Per Minute) so you can quickly muscle through obstacles and tough or frozen ground. (Not available on 580N EP or 580N backhoes).

The CASE 570N EP tractor loader combines unbeatable lifting strength, ground speeds as fast as 24mph, and user-friendly features to provide contractors with a skip loader that is impressively cost effective, and incredibly easy to own and operate. It is available with a rear 540-RPM PTO (Power Take Off) or 3-point hitch, as well as a hydraulic front quick coupler for optimal versatility. The CASE 570N EP tractor loader has a full height lifting capacity of 6,503 LB., giving you more than three tons of lifting strength to move, load and stock more piles, palletes, and material. Loader arms have heavy-duty in-line parallel linkage with a solid thru-pin design, dual bucket cylinders and a standard material retention feature to evenly transfer bucket stress up and through full dump. It all works together to provide faster cycles with less spillage.

The enhanced CASE G Series wheel loaders simplify operation through a touchscreen display and give operators even greater control with adjustable electro-hydraulic controls, optimized power modes and programmable configurable buttons near the joystick. These buttons put your most common settings and functions mere inches away from the joystick, further simplifying operation. All while delivering — and improving — the power, productivity, and efficiency you already expect from CASE G Series wheel loaders. Extreme fuel efficiency, lower engine operating temperatures and a no DPF/no regen emissions solution are matched with features designed to shorten cycle times, increase uptime, and make you even more efficient. An optional, factory-integrated payload system drives greater accuracy and loading efficiency in operations from quarries and job sites to feedlots and supply yards — and makes the investment/deployment in a payload system entirely turnkey (no separate financing/installation/etc.).

C Series motor graders expand the CASE lineup with well-equipped models ideally suited for small-to-mid-size grading operations for municipalities, road maintenance and general construction. Their SCR-only Tier 4 Final engine solution delivers fuel-saving performance with minimal cost or maintenance from the operator and with the product assurance of ProCare, ownership and upkeep has never been easier. Models come standard with the productivity-boosting features operators want and are available as standard drive or AWD, and as machine control-ready for integrating into precision fleets. C Series graders deliver smooth, automatic shifting thanks to an Ergopower transmission and torque converter. And with the hydraulic differential lock and automatic power splitting, torque is instantly transferred from a slipping tire to one with more traction, providing constant traction without throttle adjustment necessary.

The CASE H Series rough terrain forklifts get it done smoother, easier, and faster. With fast lifting speeds, roading speeds of up to 24 mph (38.6 km/h), lifting capacities of up to 8,000 lbs. and a slew of unique features that keep loads level and forklift operators comfortable, these high-performance, Tier 4 Final forklifts truly do raise the bar. Rough terrain forklifts are designed for two things: lifting and moving loads. We have engineered the H Series forklifts to be the best at both. With lifting speeds of 107 feet per minute and roading speeds of 24 mph, you will be able to raise, haul and place quicker to finish the job faster.

The all-new E Series excavators build on that legacy with seven new models - including two new class sizes - designed from the ground up to revolutionize the operator experience through laser focus on the things operators care about most: reliability, cab comfort and performance. We give you a full line-up of solutions for every size and type of jobsite, whether you are trenching in open fields or working a single lane on the highway. And the growing list of OEM-fit machine control technologies available throughout the new E Series lineup shows our commitment to always delivering improved performance, precision, and profitability.

The CASE M Series dozers are among the most powerful and efficient — and now even more precise with factory-fit machine control. This makes it easier than ever to get into machine control and to experience its benefits: increased productivity, improved performance, and reduced wear-and-tear on your dozer fleet. Match that with industry leading power, extreme visibility to the work area, an intuitive operator interface/experience, and the full support of CASE and its dealer network — and CASE M Series Dozers will drive your success from heavy bulldozer work to fine grading. It is all about the drawbar pull — and the tractive effort and related pushing power it creates. CASE M Series dozers provide best-in-class drawbar pull (varies by model), and a powerful and robust undercarriage with a variety of track and extended life options to meet your pushing needs.

CASE Minotaur™ DL550 — an all-new, industry-first equipment category: the compact dozer loader. The integrated C-frame delivers true dozer performance and the agility and finesse of a loader. CASE Universal Machine Control allows you to use the precision construction technology you prefer*. It is compatible with hundreds of attachments, and the addition of an industry-exclusive fully integrated ripper makes this machine one-of-a-kind. It has the strength, attitude, and intelligence to stake a claim as the industry's most versatile and powerful compact machine.

Minotaur demonstrates CASE's commitment to delivering real-world innovation rooted in customer need. With 29 patents**, more than 10,000 field test hours, multiple customer clinics, countless operator evaluations, product refinements and even more evaluations after that — we've put this machine to the test to deliver you the highest standard in quality. Built mean for tough conditions and smart for precision grading, you can take it all on with confidence. Transform your operation with CASE Construction Equipment.

*Machine control solution of your choice sold separately

**21 patents granted, 8 pending

		No two compaction jobs are the same. All three series of CASE vibratory rollers — double drum, single drum, and pneumatic tire — provide operators with the right combination of brute compaction force and precise control for all materials, lift profiles and jobsites. Double drum. Combi. Compact. Large Frame. CASE offers compaction solutions for every asphalt job, from driveways and bike paths to highways and commercial parking lots. Industry-leading climbing up to 67 percent grade matches with a design for powerful compaction while remaining versatile, easy to transport and fuel efficient. The PT240D provides the flexibility for both sub-base and asphalt compaction in large-scale paving projects, improving compaction quality and completing the work in fewer passes — all in a Tier 4 Final machine.
70	Within this RFP category there may be subcategories of solutions. List subcategory titles that best describe your products and services.	There are various subcategories of solutions that may describe our equipment these include earth moving equipment, agriculture, residential construction, utilities, quarry and aggregates, roads and bridges, landscaping, waste and scraping, non-residential construction, and snow removal. CNH INDUSTRIAL supports your municipality by optimizing equipment for productivity. That also means we are constantly striving to design machines that are simple to own. Our customers provide input to help guide machine enhancements, to improve serviceability, visibility, stability, power, ease of operation and transport, extended time between refuelling, noise reduction and cold-weather starting – just to name a few. And when you buy equipment from CNH INDUSTRIAL our relationship does not stop at the transaction. CNH INDUSTRIAL dealer network is on-hand to help you build the right equipment for your jobsite, and after you buy, for advice on daily checks, operator environment configuration and help with planned maintenance.

Table 14B: Depth and Breadth of Offered Equipment Products and Services

Indicate below if the listed types or classes of equipment, products, and services are offered within your proposal. Provide additional comments in the text box provided, as necessary.

Line Item	Category or Type	Offered *	Comments
71	Wheeled, tracked, and backhoe loaders	<input checked="" type="radio"/> Yes <input type="radio"/> No	Case construction provides (7) different TLB models ranging from 74 (HP) horsepower to 110 (HP)
72	Motor Graders	<input checked="" type="radio"/> Yes <input type="radio"/> No	Case Construction offers two classes of Motor Graders, the 836C (137 HP) and the 856C (173 HP).
73	Wheeled and tracked excavators	<input checked="" type="radio"/> Yes <input type="radio"/> No	Case construction offers seven different models of compact excavators, two types of midi excavators and sixteen diverse types of heavy excavators (full-size excavators).
74	Bulldozers, compactors, scapers, articulated and rigid haulers	<input checked="" type="radio"/> Yes <input type="radio"/> No	CNH INDUSTRIAL (Case New Holland Industrial) offers (6) Bulldozers ranging from 68 to 214 horsepower
75	Cranes	<input type="radio"/> Yes <input checked="" type="radio"/> No	
76	Accessories or attachments for the offering in #71-75 above	<input checked="" type="radio"/> Yes <input type="radio"/> No	CNH INDUSTRIAL (Case New Holland Industrial) provides hundreds of attachments specifically designed to meet your equipment needs. We will include brochures highlighting the vast array of attachments we provide that range from snow-pushers, augers, bale handlers, buckets, brooms, and much more.
77	Technology or services for the offering in #71-75 above	<input checked="" type="radio"/> Yes <input type="radio"/> No	CASE ProCare is the most comprehensive and standard-from-the-factory heavy machine support program in the industry. It comes with a 3-year/3000-hr full machine factory warranty, 3-year/2000-hr planned maintenance and 3-year Advanced SiteWatch subscription. With CASE ProCare, you receive complete factory-provided coverage on select new heavy machine orders.

Table 14C: Required Offering of Equipment

Indicate below if the proposer's proposal includes at least one (1) of the following listed types or classes of equipment. Provide additional comments in the text box provided, as necessary.

Line Item	Category or Type	Offered	Comments
78	Wheel loader with published net horsepower (HP) of at least 300 HP	<input checked="" type="radio"/> Yes <input type="radio"/> No	CASE Construction offers two Wheel Loader's with published net horsepower (HP) of at least 300 HP.
79	Wheeled or tracked excavator with a published net horsepower (HP) of at least 150 HP	<input checked="" type="radio"/> Yes <input type="radio"/> No	Case Construction provides (10) full-sized excavators with a published net horsepower (HP) of at least 150 HP.
80	Motor Grader with a published maximum operating weight of at least 30,000 lbs.	<input checked="" type="radio"/> Yes <input type="radio"/> No	Case construction has (1) Motor Grader with a published maximum operating weight of at least 30,000 lbs.
81	Rough terrain, all terrain, crawler, floating, lattice, or telescopic crane with a published maximum lifting capacity of at least 300 tons and a published maximum boom length of at least 150 feet	<input type="radio"/> Yes <input checked="" type="radio"/> No	CNH INDUSTRIAL (Case New Holland Industrial) does not have Cranes in its current offering.

Exceptions to Terms, Conditions, or Specifications Form

Only those Proposer Exceptions to Terms, Conditions, or Specifications that have been accepted by Sourcewell have been incorporated into the contract text.

Documents**Ensure your submission document(s) conforms to the following:**

1. Documents in PDF format are preferred. Documents in Word, Excel, or compatible formats may also be provided.
2. Documents should NOT have a security password, as Sourcewell may not be able to open the file. It is your sole responsibility to ensure that the uploaded document(s) are not either defective, corrupted or blank and that the documents can be opened and viewed by Sourcewell.
3. Sourcewell may reject any response where any document(s) cannot be opened and viewed by Sourcewell.
4. If you need to upload more than one (1) document for a single item, you should combine the documents into one zipped file. If the zipped file contains more than one (1) document, ensure each document is named, in relation to the submission format item responding to. For example, if responding to the Marketing Plan category save the document as "Marketing Plan."
 - Pricing - CNHI Price pages.zip - Friday January 13, 2023 07:29:27
 - Financial Strength and Stability - CNHI Annual report & Sustainability report.zip - Friday January 13, 2023 07:37:31
 - Marketing Plan/Samples - Buyers Guide back page.docx - Friday January 13, 2023 07:21:33
 - WMBE/MBE/SBE or Related Certificates (optional)
 - Warranty Information - CNHI Warranty.zip - Friday January 13, 2023 07:32:04
 - Standard Transaction Document Samples - NH CE and Case CE matrix.zip - Thursday January 12, 2023 14:43:50
 - Upload Additional Document - CNHI awards, certificates & licenses & Brochures.zip - Friday January 13, 2023 09:54:58

Addenda, Terms and Conditions

PROPOSER AFFIDAVIT AND ASSURANCE OF COMPLIANCE

I certify that I am the authorized representative of the Proposer submitting the foregoing Proposal with the legal authority to bind the Proposer to this Affidavit and Assurance of Compliance:

1. The Proposer is submitting this Proposal under its full and complete legal name, and the Proposer legally exists in good standing in the jurisdiction of its residence.
2. The Proposer warrants that the information provided in this Proposal is true, correct, and reliable for purposes of evaluation for contract award.
3. The Proposer, including any person assisting with the creation of this Proposal, has arrived at this Proposal independently and the Proposal has been created without colluding with any other person, company, or parties that have or will submit a proposal under this solicitation; and the Proposal has in all respects been created fairly without any fraud or dishonesty. The Proposer has not directly or indirectly entered into any agreement or arrangement with any person or business in an effort to influence any part of this solicitation or operations of a resulting contract; and the Proposer has not taken any action in restraint of free trade or competitiveness in connection with this solicitation. Additionally, if Proposer has worked with a consultant on the Proposal, the consultant (an individual or a company) has not assisted any other entity that has submitted or will submit a proposal for this solicitation.
4. To the best of its knowledge and belief, and except as otherwise disclosed in the Proposal, there are no relevant facts or circumstances which could give rise to an organizational conflict of interest. An organizational conflict of interest exists when a vendor has an unfair competitive advantage or the vendor's objectivity in performing the contract is, or might be, impaired.
5. The contents of the Proposal have not been communicated by the Proposer or its employees or agents to any person not an employee or legally authorized agent of the Proposer and will not be communicated to any such persons prior to Due Date of this solicitation.
6. If awarded a contract, the Proposer will provide to Sourcwell Participating Entities the equipment, products, and services in accordance with the terms, conditions, and scope of a resulting contract.
7. The Proposer possesses, or will possess before delivering any equipment, products, or services, all applicable licenses or certifications necessary to deliver such equipment, products, or services under any resulting contract.
8. The Proposer agrees to deliver equipment, products, and services through valid contracts, purchase orders, or means that are acceptable to Sourcwell Members. Unless otherwise agreed to, the Proposer must provide only new and first-quality products and related services to Sourcwell Members under an awarded Contract.
9. The Proposer will comply with all applicable provisions of federal, state, and local laws, regulations, rules, and orders.
10. The Proposer understands that Sourcwell will reject RFP proposals that are marked "confidential" (or "nonpublic," etc.), either substantially or in their entirety. Under Minnesota Statutes Section 13.591, subdivision 4, all proposals are considered nonpublic data until the evaluation is complete and a Contract is awarded. At that point, proposals become public data. Minnesota Statutes Section 13.37 permits only certain narrowly defined data to be considered a "trade secret," and thus nonpublic data under Minnesota's Data Practices Act.
11. Proposer its employees, agents, and subcontractors are not:
 1. Included on the "Specially Designated Nationals and Blocked Persons" list maintained by the Office of Foreign Assets Control of the United States Department of the Treasury found at: <https://www.treasury.gov/ofac/downloads/sdnlist.pdf>;
 2. Included on the government-wide exclusions lists in the United States System for Award Management found at: <https://sam.gov/SAM/>; or
 3. Presently debarred, suspended, proposed for debarment, declared ineligible, or voluntarily excluded from programs operated

by the State of Minnesota; the United States federal government or the Canadian government, as applicable; or any Participating Entity. Vendor certifies and warrants that neither it nor its principals have been convicted of a criminal offense related to the subject matter of this solicitation.

By checking this box I acknowledge that I am bound by the terms of the Proposer's Affidavit, have the legal authority to submit this Proposal on behalf of the Proposer, and that this electronic acknowledgment has the same legal effect, validity, and enforceability as if I had hand signed the Proposal. This signature will not be denied such legal effect, validity, or enforceability solely because an electronic signature or electronic record was used in its formation. - Amy Swett, Government & Fleet Sales Account Manager, CNH Industrial America LLC

The Proposer declares that there is an actual or potential Conflict of Interest relating to the preparation of its submission, and/or the Proposer foresees an actual or potential Conflict of Interest in performing the contractual obligations contemplated in the bid.

Yes No

The Bidder acknowledges and agrees that the addendum/addenda below form part of the Bid Document.

Check the box in the column "I have reviewed this addendum" below to acknowledge each of the addenda.

File Name	I have reviewed the below addendum and attachments (if applicable)	Pages
Addendum_5_Heavy_Construction_Equipment_RFP_011723 Tue January 10 2023 08:47 AM	<input checked="" type="checkbox"/>	1
Addendum_4_Heavy_Construction_Equipment_RFP_011723 Fri January 6 2023 09:51 AM	<input checked="" type="checkbox"/>	2
Addendum_3_Heavy_Construction_Equipment_RFP_011723 Thu December 29 2022 12:33 PM	<input checked="" type="checkbox"/>	2
Addendum_2_Heavy_Construction_Equipment_RFP_011723 Wed December 21 2022 01:49 PM	<input checked="" type="checkbox"/>	1
Addendum_1_Heavy_Construction_Equipment_RFP_011723 Thu December 15 2022 09:27 AM	<input checked="" type="checkbox"/>	1

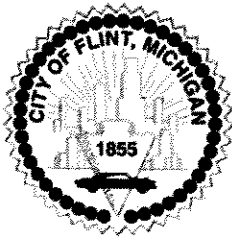

RESOLUTION NO.: 240304

PRESENTED: 7-17-2024

ADOPTED: _____

SOURCEWELL CONTRACT
#122123-RVG-1

BY THE CITY ADMINISTRATOR:

RESOLUTION TO UTILIZE OPIOID SETTLEMENT FUNDING AND ARPA FUNDING FOR THE PURCHASE OF (2) AMBULANCE/EMT UNITS FOR THE CITY OF FLINT FIRE DEPARTMENT

WHEREAS, To better serve the City of Flint residents and community, The Flint Fire Department has recently established an in-house ambulance service to help reduce response times, and increase safety and well-being for the residents in need of emergency medical transportation.

WHEREAS, Flint City Council adopted Resolution #240102 on March 25, 2024, authorizing the use of Opioid Settlement funding for the purchase of the first ambulance/EMT and equipment and supplies for the vehicle in the amount not to exceed \$225,000.00.

WHEREAS, The City of Flint Fire Department and Fleet Division have utilized the Rev Group Inc./AEV Ambulance Sourcewell contract #122123-RVG-1 to procure (2) Ford Transit EMT vehicles in an amount not to exceed \$364,834.00 to ensure that the city's ambulance services can be provided 24/7 and remain in state regulated compliance. Additional supplies needed to outfit the apparatus such as decaling, equipment, medical/safety supplies, etc., will be procured in accordance with the City's purchasing ordinance and policies for an overall cost not-to-exceed \$400,000.00.

Funding is to come from the following account(s):

Account Number	Account Name/ Grant Code	Amount
288-266.210-581.801	Opioid Settlement Funding As designated by Finance Department after City Council approval	\$200,000.00
101-000.000-389.287	Fund Balance-assigned ARPA , designated by Finance Upon City Council approval	\$200,000.00
	FY2025 TOTAL	\$400,000.00

IT IS RESOLVED, that the Flint City Council appropriates Opioid Settlement funds in an amount not to exceed \$200,000.00 to purchase (2) ambulances and needed supplies and equipment for operations of the ambulances services.

BE IT FURTHER RESOLVED, That the appropriate City Officials are authorized to appropriate \$200,000.00 in Fund Balance Assigned ARPA monies to the cost of the (2) ambulances and needed supplies and equipment for operations of the ambulance services. Procurement will follow compliance and procedures in accordance with Treasury Final Rules.

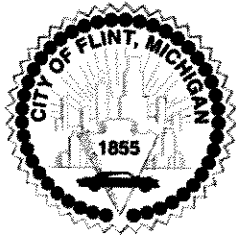

RESOLUTION NO.: _____

PRESENTED: _____

ADOPTED: _____

APPROVED AS TO FORM:

William Kim (Jul 15, 2024 16:03 EDT)
William Kim, City Attorney

APPROVED AS TO FINANCE:

Phillip Moore (Jul 15, 2024 15:04 EDT)
Phillip Moore, Chief Financial Officer

FOR THE CITY OF FLINT:

CLYDE D EDWARDS / A0258
CLYDE D EDWARDS / A0258 (Jul 15, 2024 17:30 EDT)
Clyde Edwards, City Administrator

APPROVED BY CITY COUNCIL:

APPROVED AS TO PURCHASING:

Lauren Rowley, Purchasing Manager



Final Type II
Ambulance Proposal
Sourcewell Contract #122123-RVG-1

07/09/2024
City of Flint - Fleet Department
702 W. 12th Street
Flint, MI 48503
Attn: Marquita Blair, Fleet Administrator

Description	Qty	Unit price	Total price
2023 Ford T-350 MR W2C AWD Transit Medium Roof 3.5L Eco V6 148"	2	\$121,016.00	\$242,032.00
Stryker, No 6390, Power Load, Installed	2	\$31,092.00	\$62,184.00
Stryker 6506 Power-PRO XT (High Config)	2	\$29,309.00	\$58,618.00

Terms:

Delivery: Immediate
Payment: Due in full at delivery

Subtotal	\$362,834.00
Freight	\$2,000.00

TOTAL \$364,834.00

X  Date: 7/9/24
Name: John "Mack" Arnos Jr.
Title: President

X _____ Date: _____
Name:
Title:



City of Flint
 Marquita Blair, Fleet Administ Blair, Fleet Administrator
 702 W. 12th Street
 Flint, MI 48503
 810-237-2411
 extension 2811
 mblair@cityofflint.com

R.S.V.P., Inc.
 Mack Amos
 2845 York St.
 Toledo, OH 43605
 419.764.4499
 mack@rsvpambulance.com

Exp. Date: 08/02/2024
 Quote No: 10181-0003

Create Date: 07/03/2024
 City of Flint - AEV Ford T-350 MR AWD Transit

Rev. Date: 07/08/2024

PART NO	S	DESCRIPTION	QTY	ID	EACH	EXTENDED
== *****BID STANDARDS Transit - 38.002 06/03/24 ==						
00-00-0107		-- Order Date: Post June 1st, 2024	1	AEV	0.00	0.00
00-00-0214		 -- Ambulance Built to CAAS GVS 3.0 Certification and Star Of Life GSA Dual Cert Dual Certifications required. Two sets of stickers installed in oxygen compartment. CAAS GVS 3.0 Certification issued, Sticker issued for completed Vehicle. Exception report generated as necessary. Payload Capacity > minimum per vehicle with optional permanently mounted equipment shall be per the ambulance type. Weight spreadsheet shall calculate each seating position at 175 lbs. Weight analysis per CAAS GVS table. Additional Exceptions to print or report out when chosen. >>> >> Backup camera is required on every model, please ensure to add <<	1	AEV	250.00	250.00
00-00-0220		 -- Upgrade suggestions to sales to meet CAAS GVS 3.0 The following items shall be reviewed with the customer, and added or take an exception to CAAS GVS 3.0 >> Backup alarm Must NOT have a disable switch. << >Front OEM bumper must remain OEM, all others are an exception >> >C.18.7 FSAM (AEV) does not provide a final BOM per vehicle, no option to meet. > C.9.6 rear bumper must contain open bar grate design. (AEV std flip step meets, provided not modified. >C.10.2 pass thru cab connection must be latching, >on-board permanent mount suction system required >trash enclosure to have a latching lid. > 2nd Fire Extinguisher to be added to the order, installed.	1	AEV	0.00	0.00
00-00-0406		 -- Vehicle Destination any state other than Connecticut	1	AEV	0.00	0.00
00-10-0015		Vehicle Quantity (Vehicles)	1	AEV	0.00	0.00
00-91-0021		ACCOUNT SPECIALIST: Randall Pennington	1	AEV	0.00	0.00
00-99-9000		Revision Level: 0 - Zero - ORIGINAL VERSION	1	AEV	0.00	0.00
== Transit Gold Group Medium Roof Van Chassis - 38.002 06/03/24 ==						
21-0H-014		2023 Ford T-350 MR W2C AWD Transit Medium Roof 3.5L Eco V6 148" >>>Special Order Transit >>> Special lead time applies. T-350 Medium Roof dimensions Wheelbase 147.6", overall height, 101.1", length, 238 3.5L GTDI V6 Ecoboost Gasoline Engine >>>>20C GVWR 9,500 pounds AEV STD W2C chassis spec	1	AEV	54066.00	54066.00

PART NO	S	DESCRIPTION	QTY	ID	EACH	EXTENDED
21-3T-E515		<i>/-- OEM Front License plate bracket - Ship loose</i>	1	AEV	0.00	0.00
		<i>== Conversion Options Type II Transit Gold Medium Roof - 38.002</i>		AEV		
		<i>06/03/24 ==</i>				
21-3T-E473		Transit - High Idle - Intermotive 2020+ MDUL-BAIM514B	1	AEV	0.00	0.00
21-TP-0005		Tire Pressure Monitoring System: OEM, Basic Light in Dash	1	AEV	0.00	0.00
23-2F-HR6A		Headroom (ceiling height): 66 1/2" (+/- 1/4") Transit Medium Roof	1	AEV	0.00	0.00
24-2F-5KTM		***Van Model, Structural Alterations*** Transit Medium Roof	1	AEV	0.00	0.00
24-EA-1122		-- Mud Flaps Front: Van, Black Hard Plastic AEV LOGO	1	AEV	0.00	0.00
24-EA-1132		-- Mud Flaps Rear: Van, Black Hard Plastic AEV LOGO	1	AEV	0.00	0.00
24-EA-1136		-- Fender Cladding Front and Rear: OEM Transit	1	AEV	0.00	0.00
24-OE-BUM		Rear Bumper: OEM Transit	1	AEV	0.00	0.00
24-ST-GSBG		-- Transit Rear Step; Diamond plate with Bar Grate Fixed no pivot	1	AEV	0.00	0.00
25-00-TOP3		TOP: Transit Medium Roof OEM	1	AEV	0.00	0.00
25-00-TOPG		-- Transit on top Rear of Body Spoiler roof ADDS 2 1/2" to overall 2022+	1	AEV	0.00	0.00
25-EL-43S9		-- Third (3rd) Brake Light: Kinequip LED	1	AEV	0.00	0.00
32-B0-0001		-- Pre-Painted Part White in Color	1	AEV	0.00	0.00
		SCENE/FLOOD LIGHTS - Transit Medium Roof		AEV		
25-EL-45LC		-- Left Scene Lights: (2) Whelen 700-LED 7SCOENZR	1	AEV	0.00	0.00
06-EL-18LF		-- Left Flood Activate: Left Flood Switch	1	AEV	0.00	0.00
25-EL-45TH		-- Right Scene Lights: (2) Whelen 700-LED 7SCOENZR	1	AEV	0.00	0.00
25-EL-02SE		-- Flanges: NONE, for the above Scene Lights	1	AEV	0.00	0.00
26-EL-18RT		-- Activate: Right Flood Switch and open CSE Door	1	AEV	0.00	0.00
25-EL-46RC		-- Rear Load Lights: (2) Whelen 700-LED, 7SCOENZR ilos LED ILOS	1	AEV	239.00	239.00
06-EL-18RE		-- Activate: Rear Flood Switch, Reverse and Lead RA Door	1	AEV	0.00	0.00
		ENVIRONMENTAL		AEV		
25-HA-129		HVAC SYSTEM: Kinequip Ducted, Transit	1	AEV	0.00	0.00
25-HA-1301		-- A/C Condenser: OEM, located in front of the radiator.	1	AEV	0.00	0.00
25-HA-1404		-- Heater Hoses: EPDM - Nomex Rubber (per Ford QVM)	1	AEV	0.00	0.00
25-HA-1408		-- AC Hoses: AOC AIR-O-CRIMP Hose -	1	AEV	0.00	0.00
25-HA-14A		-- GRILLE, Return Air: Stamped Powder Coated Steel Install GASK-JYC) between Grille and Cabinet	1	AEV	0.00	0.00
25-HA-14B0		-- FILTER, Washable Carbon Pre-Filter	1	AEV	0.00	0.00
25-HA-14E5		-- Patient Cabin Air Vents: Intake = Static, Exh = Power	1	AEV	0.00	0.00
25-HA-1520		-- Water Pump, Additional, To work with rear heater	1	AEV	324.00	324.00
25-HA-2103		-- HVAC Switching: 3 way from Cab to Patient Area -	1	AEV	0.00	0.00
30-HA-02T		<i>/-- Optional Thermostat, Rear Digital Kinequip Mini Control</i> THER-642	1	AEV	33.00	33.00
30-HA-LOC		<i>/-- Install Location - Streetside Action Area</i>	1	AEV	0.00	0.00
25-HA-14V0		Fresh Air Vent-Transit Medium Roof Interior Lower Panel	1	AEV	0.00	0.00
25-IL-2K17		CEILING PANELS (Transit): Laminated ACM Ducted	1	AEV	0.00	0.00
25-IL-0306		-- Dome Lts, LED K-EDGE, (3) Streetside, (3) Curbside,	1	AEV	0.00	0.00
29-MH-08A		-- IV Hook No 1: Hook 07 W/Velcro bag stabilizer - STD	1	AEV	0.00	0.00
29-MH-100		-- LOCATION: Over head/chest area, primary patient on COT	1	AEV	0.00	0.00
29-MH-08A		-- IV Hook No 2: Hook 07 w/ Velcro bag stabilizer - STD	1	AEV	0.00	0.00
29-MH-100		-- LOCATION: Over Knee/Waist area, primary patient on COT	1	AEV	0.00	0.00
29-MH-2AS		-- Recessed, Center Grab Rail, 1.25 Dia..... x 72" Gray Anti microbial, 3-Point Mount in standard location on the center of ceiling.	1	AEV	0.00	0.00
25-IN-1STE		Insulation: Circumferential PKG, Reflective w/ Air cell core 100% coverage	1	AEV	0.00	0.00
		WARNING LIGHT SYSTEM - Whelen LED - Transit Medium Roof		AEV		
25-FS-0708		-- Flasher : Solid State K-FM301 Set lights to steady burn, to flash off flasher	1	AEV	0.00	0.00

PART NO	S	DESCRIPTION	QTY	ID	EACH	EXTENDED
06-SW-PS0		-- Warning Light SWITCH: center console, Primary / Secondary	1	AEV	0.00	0.00
25-FS-1160		-- KFA-FM3-01Flash pattern; Alternate Flash	1	AEV	0.00	0.00
25-J9-9007		-- Transit Front Upper Zone Warning Light Packages Medium Roof	1	AEV	0.00	0.00
25-J9-9001		--	1	AEV	0.00	0.00
05-LB-6900		-- Alternative Lightbar Switching, Prim/Sec	1	AEV	0.00	0.00
25-PA-LM7		-- Transit Front Brow light mount Medium Roof (5) Lights -Painted White STD	1	AEV	0.00	0.00
32-B0-0001		-- Pre-Painted Part White in Color	1	AEV	0.00	0.00
25-PH-LT1A		-- Flange: (1) 700-FLANGE Chrome	5	AEV	0.00	0.00
25-PL-LWG		-- Whelen 700 Super LED, Clear LED/Clear Lens, Programmable ilos	1	AEV	0.00	0.00
25-PL-LWG		-- Whelen 700 Super LED, Red LED/Clear Lens, Programmable ilos	4	AEV	0.00	0.00
25-N0-0006		-- Rear Spoiler Transit Medium Roof	1	AEV	0.00	0.00
25-W0-002		-- (2) Primary Grille lights- Whelen Wide Angle Ion Surface Mount Transit 2021+	1	AEV	0.00	0.00
25-PM-LS62		-- Light Whelen Wide Angle ION Red LED chrome flange surface mount Each ILOS	2	AEV	21.00	42.00
25-W0-003		-- (2) Front Intersection Lights LIN3 - std	1	AEV	0.00	0.00
25-PH-LS06		-- Whelen TIRLIN3, PAIR RED LED, Chrome Hsg	1	AEV	0.00	0.00
25-W0-005		-- (4) side warning lights 7x3 LED Transit Medium Roof	1	AEV	0.00	0.00
25-N0-0008		-- Housings Transit Medium Roof sides plus Amber LED ICC lights	1	AEV	0.00	0.00
25-PL-N010		-- Whelen 700, RED LED/CLEAR Lens (Super LED), Programmable Std	4	AEV	0.00	0.00
25-W0-007		-- Rear Exterior Warning Lights on Spoiler- 2020+ Transit Roof -std	1	AEV	0.00	0.00
25-PL-N010		-- Whelen 700, RED LED/CLEAR Lens (Super LED), Programmable Std	2	AEV	0.00	0.00
25-PL-N016		-- Whelen 700, Amber LED /CLEAR Lens (Super LED), Programmable S/T Std	2	AEV	0.00	0.00
26-00-0053		Tremco Ignition Security Kit - Transit -Current Plug and play kit, Includes hardwired main disconnect switch on harness, air bladder type switch. System Auto-Engages.	1	AEV	202.00	202.00
26-BA-Q634		Battery Switch: Cole Hersee 2484-16 Paddle in chassis cab area LOCATION: Front of Driver's seat base With Face Plate LABEL	1	AEV	0.00	0.00
26-EB-12M1		Cab Ovhd Lights: None	1	AEV	0.00	0.00
26-EC-300U		Backup Camera System Ford Transit OEM Display into OEM Radio 2020+	1	AEV	0.00	0.00
26-EC-3580		Electrical AEV-SSD system Transit, Medium Roof	1	AEV	0.00	0.00
26-EC-3601		-- Transit Cab overhead, Hinged ABS Electrical Door Gray with 2-Latches standard	1	AEV	0.00	0.00
26-RR-S07		 -- CONSOLE, Floor/Ovhd : Transit AEV-SSD -8 lbs Requires additional lower console IATS for Siren mounting LED backlighting, UP to 6 lighted indicator positions Volt meter built in Siren mounts to OEM console, if left in.	1	AEV	147.00	147.00
26-RR-237		 -- Transit Cab Upper and Rear AA AEV-SSD Control Panels	1	AEV	0.00	0.00
26-RR-23A		 -- Engraved LOGO: AEV	1	AEV	0.00	0.00
26-RR-239		 -- Console, radio, add-on, in cab: NONE	1	AEV	0.00	0.00
26-SO-113		 -- 12v outlet OEM in dash - Transit	1	AEV	0.00	0.00
26-SS-0625		 -- Siren: Whelen, WS295HFSA7, Transit ilos remote head Remote Head siren. Siren Head in secondary Console Amplifier installed behind passenger seat base removable microphone Sire-A7	1	AEV	42.00	42.00
06-SS-SW0		 -- Siren / OEM Horn Switch: In Cab Console	1	AEV	0.00	0.00
26-SS-070T		 -- Location, Siren Head: Console	1	AEV	0.00	0.00
26-SS-CP23		 -- Speaker #1 Surface Mount Transit 2020+ Cast Black Powder Coat 3825	1	AEV	0.00	0.00

PART NO	S	DESCRIPTION	QTY	ID	EACH	EXTENDED
26-EC-4300		Back Up Alarm: Standard	1	AEV	0.00	0.00
26-EC-43C0		-- Back Up Alarm Cut Off Switch: NONE	1	AEV	0.00	0.00
26-IG-0250		Inverter : Vanner LIFESINE 1100 Pure Sine Wave, w 55watt 3 stage charger	1	AEV	1617.00	1617.00
26-EC-02L3		-- Location: Behind vent in Base wall	1	AEV	0.00	0.00
26-EC-03A		-- Portable Equip Charging Circuits: Included in Inverter	1	AEV	0.00	0.00
26-EC-03A		-- PREWIRE LOCATION: (1)Cab Console, (1) Behind A/A	1	AEV	0.00	0.00
26-EC-03C9		-- Portable Equip Power Source: Ignition and/or Shoreline	1	AEV	0.00	0.00
26-IG-03A0		-- Battery Charger/Conditioner: 55A - Built into Inverter	1	AEV	0.00	0.00
26-IG-0003		-- Built-in Battery Charger: Enable - Wire to Batteries	1	AEV	0.00	0.00
26-MC-011		Engine Hour meter: OEM, Gauge Cluster	1	AEV	0.00	0.00
26-RR-0003		COMMUNICATION RADIO(S) RELATED	1	AEV	0.00	0.00
26-EC-03A0		-- Radio Power No 1: 30A, Pos and Neg, 10 awg Wires	1	AEV	0.00	0.00
26-EC-03B0		-- Radio Power Source: Battery Switch Hot	1	AEV	0.00	0.00
26-EC-03D0		-- LOCATION: Behind Driver's Seat	1	AEV	0.00	0.00
26-EC-03A2		-- Radio Power No 2: 30A, Pos and Neg, 10 awg Wires	1	AEV	0.00	0.00
26-EC-03B0		-- Radio Power Source: Battery Switch Hot	1	AEV	0.00	0.00
26-EC-03E0		-- LOCATION: Action Area Console	1	AEV	0.00	0.00
26-RR-0120		-- Coaxial Cable, No 1: Type RG-58U, No connectors	1	AEV	0.00	0.00
26-RR-01Q1		-- ORIENTATION POINT: Roof Port No 1 located 27" back from front edge AND centered	1	AEV	0.00	0.00
26-RR-01P3		-- Coax Access: thru center Grab rail recess	1	AEV	0.00	0.00
26-RR-01T1		-- TERMINATION POINT: Behind Driver's seat w/ 36" Tail	1	AEV	0.00	0.00
26-SO-0012		125 VAC SHORE LINE AND OUTLETS -	1	AEV	0.00	0.00
26-SO-0103		-- Shore Line Inlet: 20A Twist lock w/ Ground - std Includes a ship loose mating plug RECP-11 (1)	1	AEV	0.00	0.00
26-SO-015		-- LOCATION: Aft of driver's door on street side	1	AEV	0.00	0.00
26-SO-1399		-- **125 Volt AC OUTLETS**	1	AEV	0.00	0.00
26-SO-1413		-- 125 VAC Outlet, No 1: 15A, Hospital Grade, IVORY	1	AEV	0.00	0.00
26-SO-14LB		-- LOCATION: Action Area Wall #3	1	AEV	0.00	0.00
26-SO-140		-- Outlet mounting ORIENTATION: Vertical	1	AEV	0.00	0.00
26-SO-1424		-- 125 VAC Outlet, No 2: 15A, Hospital Grade, IVORY	1	AEV	0.00	0.00
26-SO-14L3		-- LOCATION: RF ALS, (See Drawing)	1	AEV	0.00	0.00
26-SO-140		-- Outlet mounting ORIENTATION: Vertical	1	AEV	0.00	0.00
26-SO-1098		INTERIOR 12 Volt OUTLETS	1	AEV	0.00	0.00
26-SO-1022		-- 12V Outlets, #1 & #2, Double Receptacle (SOCK-04C), STD	1	AEV	0.00	0.00
26-SO-11L	S	-- LOCATION: Action Area Wall #3	1	AEV	0.00	0.00
26-SO-1910		-- Power Source: Medical Isolator, Batt Sw Hot	1	AEV	0.00	0.00
27-00-00TR		CABINET CONSTRUCTION, GENERAL,	1	AEV	0.00	0.00
27-00-MC0		Mica Color: Gloss White	1	AEV	47.00	47.00
27-00-PCD		Polycarbonate Type/Color: Lexan - CLEAR Secure Latch EVS Comfort 1782 6-Degree Attendant seat with Per4Max Belts (S,T,P)	1	AEV	0.00	0.00
27-04-0304		-- Att Seat:1782 6-Degree AEV/EVS Comfort Black Per4Max Black Belt Black vac form Black Per4MAX seat belt system	1	AEV	0.00	0.00
27-AT-001		-- ATT SEAT BASE: Fixed on Transverse O2 Cabinet (non-swiveling) 20 1/2"-T SEAT-BOXTA for transits	1	AEV	0.00	0.00
27-SE-0908		-- 1650 Mounting plate stud system from EVS, set of two	1	AEV	0.00	0.00
27-BH-PD0		PARTITION DOOR: None, Solid Wall Partition,	1	AEV	0.00	0.00
27-BH-PD1		-- Window: 100% Sliding Lexan, 100% Open W Composite Bulkhead Frame	1	AEV	0.00	0.00
27-BH-PD1		-- Slide behind passenger in cab	1	AEV	0.00	0.00
27-BH-PD9		-- Sliding Window Locking Pin: 1/4" with Lanyard	1	AEV	0.00	0.00
27-RF-2S10		RF ALS Cabinet Space for LP Transit Medium Roof	1	AEV	0.00	0.00

PART NO	S	DESCRIPTION	QTY	ID	EACH	EXTENDED
27-RF-I204		-- Cabinet I-1: NONE	1	AEV	0.00	0.00
27-RF-I306		-- Cabinet I-2: (Under I-1) Wood lip on C/S of cabinet and on edge facing rear.	1	AEV	0.00	0.00
27-RF-I3C0		-- Open Access: CS Door and Patient Cabin, NO POST	1	AEV	0.00	0.00
27-RF-I2A7		-- Storage area secured by ALS cargo net over entire I cabinet 2-4 sections requires option 27-CA-4400 to be valid	1	AEV	0.00	0.00
27-RF-I409		-- Cabinet I-3 (Under I-2)15 "High x 24."Wide x 15"Deep -Transit med roof std Wood lip on C/S of cabinet and on edge facing rear.	1	AEV	0.00	0.00
27-RF-I2A0		-- Open Access: CS Door and Patient Cabin, Shelf Support Post Wood lip installed on shelf to retain contents	1	AEV	0.00	0.00
27-RF-I2A7		-- Storage area secured by ALS cargo net over entire I cabinet 2-4 sections requires option 27-CA-4400 to be valid	1	AEV	0.00	0.00
27-RF-I506		-- Cabinet I-4 (Under I-3) 14"High x 24"Wide x 15"Deep	1	AEV	0.00	0.00
27-RF-I2A0		-- Open Access: CS Door and Patient Cabin, Shelf Support Post Wood lip installed on shelf to retain contents	1	AEV	0.00	0.00
27-RF-I2A7		-- Storage area secured by ALS cargo net over entire I cabinet 2-4 sections requires option 27-CA-4400 to be valid	1	AEV	0.00	0.00
27-RF-I31N		-- ALS corner post standard chrome metal	1	AEV	0.00	0.00
27-RR-2K03		BULKHEAD TRANSVERSE CABINET: M-cylinder, Oxygen storage	1	AEV	0.00	0.00
27-RR-2KD3		-- O2 Cabinet Door: Inset Solid wood/ laminated.	1	AEV	0.00	0.00
27-HW-HIN		-- Hinge: 1 1/2" Stainless Steel Piano Hinge	1	AEV	0.00	0.00
27-HW-SO0		-- Lever Latch: Non-locking - Black Finish No rating, Non storage areas.	1	AEV	0.00	0.00
27-WC-O20		-- View Window: Hinged Lexan Door	1	AEV	0.00	0.00
27-DR-LX17		-- Door, Single, Hinged Left, 3/16" Lexan	1	AEV	0.00	0.00
27-00-PH01		-- Polycarbonate Handles: Full Length Extruded	1	AEV	0.00	0.00
27-DR-LZ10		-- Hinges: Stainless Spring Loaded	1	AEV	0.00	0.00
27-SB-2K0		SQUAD BENCH Transit Medium Roof	1	AEV	0.00	0.00
27-SB-LID5		-- Squad Bench Lid : Dual	1	AEV	0.00	0.00
27-SB-LH00		-- Hinge, Squad Bench Lid(s): Butt Style Hinges	1	AEV	0.00	0.00
27-SB-LH03		-- Lid Check (Hold-open): (2) Gas Spring, Dual action	1	AEV	0.00	0.00
27-SB-LH05		-- Lid Trim: Anodized Aluminum "J-trim"	1	AEV	0.00	0.00
27-SB-LH0C		-- Latch 90deg Squad Bench to Lid: Slam Action , KITS-SBL 40 lbs Each	1	AEV	0.00	0.00
27-SB-VBB1		-- Vertical Backboard Storage SLOT: 5 1/2 " Wide x 17 1/4" Ht The opening of the backboard slot shall have heavy-duty stainless steel trim. The interior surface of the slot shall be finished with black Easy grip material.	1	AEV	0.00	0.00
27-SB-VBB5		-- Steel J-brackets: For S/B Front mounted seat belts	1	AEV	0.00	0.00
28-MH-162		-- Restraint Net head of S/B, Black Webbing, Transit std	1	AEV	0.00	0.00
28-SE-S422		-- 4-Point PER4MAX Restraint System Black - Transit	1	AEV	0.00	0.00
28-SE-S542		 -- (2) Per4Max Black on Squad Bench	1	AEV	429.00	429.00
28-SE-SB70		 -- Squad Bench: (3) Secondary patient restraints - 9" Black Buckles	1	AEV	0.00	0.00
28-SF-1002		-- Rcpt, Bio-waste/Sharps No 1: ABS Rim, Red Lexan Cover-Hd	1	AEV	0.00	0.00
07-SB-0995		-- LOCATION: Sharps head of S/B, Trash in A/A	1	AEV	0.00	0.00
27-SB-1005		-- WASTE CONTAINER: Molded (CANO-04G)	1	AEV	0.00	0.00
27-SB-1006		 -- SHARPS CONTAINER: 2-Gallon Sharps-A Gator CONT-02	1	AEV	0.00	0.00
27-TC-2K0		TOP CABINET Transit Medium Roof	1	AEV	0.00	0.00
27-TC-A009		-- Cabinet A: Wood - White Short	1	AEV	0.00	0.00
27-CB-DR32		-- Cabinet A Transit Secure Latch Sliding Window 40 lb rated	1	AEV	0.00	0.00
27-TS-11A4		-- (1) Divider: Fixed, Mica over wood, centered in cabinet	1	AEV	0.00	0.00
27-TC-B009		-- Cabinet B: Wood - White Short	1	AEV	0.00	0.00

PART NO	S	DESCRIPTION	QTY	ID	EACH	EXTENDED
27-CB-DR34		-- Doors; Cabinet B Secure Latch Sliding Window 40 lb rated	1	AEV	0.00	0.00
27-TS-11A4		-- (1) Divider: Fixed, Mica over wood, centered in cabinet	1	AEV	0.00	0.00
27-TC-M00		-- Cabinet M: Wood - White	1	AEV	0.00	0.00
27-DR-WD0		-- Door: Single Solid Wood, Flush Fitted and Trimmed	1	AEV	0.00	0.00
27-CA-212K		-- TRIM: U-shaped Door, J-trim opening	1	AEV	0.00	0.00
27-HW-S00		-- Lever Latch: Locking - Black Finish 8-lb	1	AEV	0.00	0.00
27-TC-TCAC		-- Add 'I A/C Vents: Forward of "M" Cabinet in Top Cabinet	1	AEV	0.00	0.00
27-WC-2TM		WALL CABINET: Transit Medium Roof	1	AEV	0.00	0.00
27-WC-AA0		-- Action Area Panel: One-piece	1	AEV	0.00	0.00
27-WC-AA0		-- WC A/C Access: Powder Coat Louvered Vent	1	AEV	0.00	0.00
27-WC-C01		-- Cabinet C: Stair chair Storage, Rear Slide in -	1	AEV	0.00	0.00
27-CA-2906		-- Seatbelt Strap: Black - -02014 Stair-Chair Slot Restraint Strap -100 lb	1	AEV	0.00	0.00
27-CB-DR03		-- Open Cabinet (Stair Chair): No Door, Trim Opening-	1	AEV	0.00	0.00
27-CB-BM0		-- Stair Chair bottom edge extension - DA finished aluminum	1	AEV	0.00	0.00
27-CB-BM0		-- Stair chair left edge trim: plate .090 DA Aluminum	1	AEV	0.00	0.00
27-WC-D10		-- Cabinet D1: Wall cabinet, Mid-upper, Wood, White	1	AEV	0.00	0.00
27-CB-DR24		-- Doors; Cabinet D-1 Secure Latch Sliding Window 40 lb rated	1	AEV	0.00	0.00
27-TS-11A4		-- (1) Divider: Fixed, Mica over wood, centered in cabinet	1	AEV	0.00	0.00
27-TS-12A4		-- Shelf Track: 1/2" Incremental, alum (2incl)	1	AEV	0.00	0.00
27-TS-13A4		-- (2) Shelves: Adjustable, laminate/ wood, one each side of divider std	1	AEV	0.00	0.00
27-WC-D11		-- Cabinet D2: Wall cabinet, Mid-left-lower, Wood, White	1	AEV	0.00	0.00
27-CB-DR26		-- Doors; Cabinet D-2 Secure Latch Sliding Window 40 lb rated	1	AEV	0.00	0.00
27-TS-12A1		-- Shelf Track: 1/2" Incremental, alum (1incl)	1	AEV	0.00	0.00
27-TS-13A1		-- (1) Shelf: Adjustable, Mica over wood, (Include Std)	1	AEV	0.00	0.00
27-WC-D12		-- Cabinet D3: Wall cabinet, Mid-right-lower, Wood, White	1	AEV	0.00	0.00
27-CB-DR28		-- Doors; Cabinet D-3 Secure Latch Sliding Window 40 lb rated	1	AEV	0.00	0.00
28-00-FL3A		Flooring: Loncoin II Flecks- #150, Onyx (Black)	1	AEV	358.00	358.00
28-FM-000		 -- Cabinet/Floor edge: Alum. cove trim, sealed, Std. Apply an even bead of colored, siliconized caulk to the corner prior to placing the trim.	1	AEV	0.00	0.00
28-80-0006		CSE Step Well Stainless steel overlay with Safety Tape, 90 degree 2021 Transit +	1	AEV	0.00	0.00
28-CR-09P XS		Cot Mount: Stryker, No 6390, Power Load, Installed Transit Not Compatible with cots other than Stryker! AEV Purchasing to order Power load system. AEV SYST-Powerload MOUN-POWERLOAD >> NOT AVAILABLE ON TRANSIT HIGH ROOF DIESEL ENGINE CHASSIS DUE TO PAYLOAD ALLOWANCE REQUIREMENTS <<	1	AEV	31092.00	31092.00
08-CS-3009		 -- Cot mount set up for: Stryker Power-Pro 6506	1	AEV	0.00	0.00
28-CR-09Q		 -- Cable Extension for Stryker Powerload System CONN-DTP062S CONN-WP2S 1 CONN-SOCKET 2	1	AEV	28.00	28.00
28-CR-09P		 -- mass casualty kit not requested	1	AEV	0.00	0.00
28-CR-100		 -- 12v power feed location FRONT for Stryker power load 6390 The 12 volt feed will be drilled and fed through the template FRONT hole for a Stryker power load system. The 12volt power shall be brought through the floor, with Heat shrink connectors installed.	1	AEV	0.00	0.00
28-CS-19A		 -- Cot Stop, Block: Stryker Power/Performance load. Install hook with kit	1	AEV	0.00	0.00
28-FL-STA5		Rear Threshold: Transit Stainless Steel with Anti-Skid Tape	1	AEV	0.00	0.00
28-FL-STB2		-- Spare tire release cover Ford OEM Transit rubber plug insert	1	AEV	0.00	0.00
28-OS-04B		OXYGEN / VACUUM System: Transverse, Transit Gold model	1	AEV	0.00	0.00
28-OS-0401		-- Oxygen Outlet No 1, Amico - Ohmeda/ Ohio Diamond Style	1	AEV	0.00	0.00
28-OS-040A		-- LOCATION: Action Area Panel	1	AEV	0.00	0.00

PART NO	S	DESCRIPTION	QTY	ID	EACH	EXTENDED
28-OS-0402		-- Oxygen Outlet No 2, Amico - Ohmeda/Ohio Diamond Style	1	AEV	0.00	0.00
28-OS-040A		-- LOCATION: Action Area Panel	1	AEV	0.00	0.00
28-OS-040		 -- Oxygen Outlet No 3, Amico - Ohmeda/ Ohio Diamond Style	1	AEV	189.00	189.00
28-OS-040		 -- LOCATION: Ceiling Panel, Curbside	1	AEV	0.00	0.00
28-OS-13Q		-- Rack #1: "M" Tank, Hinged Slide Assy, SAE J3058 Compliant Transverse	1	AEV	0.00	0.00
28-OS-0002		-- Rack Set up for: "M"	1	AEV	0.00	0.00
28-OS-11G1		-- Cylinder Type: OXYGEN - Green Colored Hose	1	AEV	0.00	0.00
28-OS-1303		-- Location: Transverse Bulkhead	1	AEV	0.00	0.00
28-OS-1710		-- Regulator w Elbow, Oxygen, Fixed output @ 50 psi +/-5 , CGA 540, Installed STD tested, tagged and dated by inspector.	1	AEV	0.00	0.00
28-OS-1902		-- Wrench, Oxygen, Cast aluminum, w/ lanyard or tether	1	AEV	0.00	0.00
28-OS-35ST		-- Vacuum System: SSCOR regulator/gauge panel in A/A	1	AEV	0.00	0.00
28-OS-3501		-- Collection Canister w clip No 1: Bemis, 1200 CC Capacity Action Area	1	AEV	0.00	0.00
28-OS-3502		-- VAC Plumbing: Direct from panel to canister - NO Outlet	1	AEV	0.00	0.00
28-OS-3505		-- Vacuum Pump No 1: SSCOR	1	AEV	0.00	0.00
28-OS-35L2		-- Location: Under A/A, accessible through vent cover	1	AEV	0.00	0.00
28-OS-0899		-- Portable Cylinder Rack : NONE	1	AEV	0.00	0.00
29-00-002S		-- Interior window and aluminum trim with standard satin finish- std	1	AEV	0.00	0.00
29-00-0003		Soft touch trim installed on action area upper header std	1	AEV	0.00	0.00
29-B1-0001		Transit sliding door panel lower	1	AEV	0.00	0.00
29-B1-ED22		Rear Entry Door Panels: None, OEM mounting slots exposed	1	AEV	0.00	0.00
29-MH-03B		Door Handles: (2) Chrome Plated Metal, 7",	1	AEV	0.00	0.00
29-MH-05S		5 LB Fire Ext: Installed, ILOS EXTI-01	1	AEV	19.00	19.00
34-MH-068		 -- Install location - In chassis cab behind passenger's seat on floor.	1	AEV	0.00	0.00
29-MH-05S		5 LB Fire Ext: Installed, IATS	1	AEV	125.00	125.00
29-MH-062		 -- Fire Extinguisher mounting bracket - Stainless Steel Zico QR-FEH-1-K Secure into metal reinforcement. Adjustable band clamp with snap closure. Compliant in vertical or horizontal position to SAE J3043, NFPA, AMD, GSA KKK, GSV and OSHA testing. For KIDDE Brand fire extinguisher only.	1	AEV	216.00	216.00
29-MH-05T		 -- Fire Extinguisher installed vertical beside attendant seat in patient area	1	AEV	0.00	0.00
29-MH-062		Fire Extinguisher mounting bracket - Stainless Steel Zico QR-FEH-1-K Secure into metal reinforcement. Adjustable band clamp with snap closure. Compliant in vertical or horizontal position to SAE J3043, NFPA, AMD, GSA KKK, GSV and OSHA testing. For KIDDE Brand fire extinguisher only.	1	AEV	216.00	216.00
30-EV-2004		Power Exhaust Vent: REAR, 12V, 4" In-line blower	1	AEV	0.00	0.00
30-EV-2013		Intake Vent: On Curbside Sliding Dr, -Transit MediumRoof Cast vent above window	1	AEV	0.00	0.00
30-IL-02ST		Action Area Light: 12V 12" White LED.	1	AEV	0.00	0.00
31-EX-0008		-- Van rear exit and side exit upper panels match Upholstery main colors.	1	AEV	0.00	0.00
31-00-0003			1	AEV	0.00	0.00
31-00-UB9		Upholstery Color: Black (Black) UPHO-6905 Black Vac-Form	1	AEV	0.00	0.00

PART NO	S	DESCRIPTION	QTY	ID	EACH	EXTENDED
31-00-UT0		-- Upholstery Joint Type: Vacuum Formed - Seamless	1	AEV	0.00	0.00
31-00-UT02		Upholstery Joint Type: Vacuum Formed - Seamless	1	AEV	0.00	0.00
		PAINT - STRIPES - DECALS		AEV		
32-PT-UNC		-- Undercoating : Type 2 per QVM Guidelines, STD	1	AEV	0.00	0.00
32-DC-0001		Reflective White Tape: On edges of Exterior Door Frame	1	AEV	0.00	0.00
32-PT-0202		Over All Paint Color: Oxford White (YZ)	1	AEV	0.00	0.00
32-PT-0100		-- Paint Belt: NONE	1	AEV	0.00	0.00
32-PT-2000		Lettering: NONE	1	AEV	0.00	0.00
		DETAIL		AEV		
33-KK-NSSB		Decals: NO SMOKING & SEATBELT, installed, cab & pt. area.	1	AEV	0.00	0.00
33-MH-100		Reflectors, Rectangle w chrome edge Red (2) on transit rear door lower corner	1	AEV	0.00	0.00
		SHIP LOOSE ITEMS		AEV		
34-3T-E515		TRANSIT OEM Front License plate bracket - Ship loose FORD TRANSIT front licence plate bracket	1	AEV	0.00	0.00
34-KK-KDEC		Decals: KKK / DOT Pkg, Blue/White reflective - Ship Loose	1	AEV	0.00	0.00
34-RF-STAS		-- Decals: 32" Star of Life - Ship Loose	1	AEV	0.00	0.00
34-KL-0010		AEV Logos: Installed on unit per AEV standard locations	1	AEV	0.00	0.00
34-MH-05S		Fire Extinguisher, ABC Powder, 5-pound, shipped loose, Std	1	AEV	0.00	0.00
34-XX-5000		Indemnification Statement The purchaser agrees to defend, indemnify and hold REV harmless from any claims, costs (including actual attorneys' fees), damages and liabilities caused in whole or in part by any alteration or modification of, or changes or additions to the Purchased Products OR use of product for purposes it was not designed or intended for.	1	AEV	0.00	0.00
34-ZZ-ZZZZ			1	AEV	0.00	0.00
ST-RY-KER	U	Stryker 6506 Power-PRO XT (High Config) == Van-T-2 Base Price Transit Gold Medium Roof - 38.002 06/03/24 ==	1	AEV	29309.00	29309.00
		GENERAL CONVERSION		AEV		
23-00-0001	S	Inspection & Delivery	1	AEV	1000.00	1000.00
23-47-1619	S	2023 Transit Van, T-350 Gas 3.5 L AWD Med Roof Gold Conv 24-1 08/10/23	1	AEV	62379.00	62379.00
23-ZZ-ZZZZ			1	AEV	0.00	0.00
36-EO-0001		-- ***END OF ORDER***	1	AEV	0.00	0.00
		Total				182,417.00
		APPROVED :				
		DATE :				

240102



RESOLUTION NO.: _____

PRESENTED: 3-20-2024

ADOPTED: 3-25-2024

RESOLUTION TO UTILIZE OPIOID SETTLEMENT FUNDING FOR THE PURCHASE OF AN AMBULANCE/EMT UNIT FOR THE FLINT FIRE DEPARTMENT

To better serve the City of Flint residents and community, the Flint Fire Department recommends establishing an in-house EMT/Ambulance service to reduce response times, increasing safety and well-being of residents in need of emergency medical transportation;

The Division of Purchasing and the Fleet Services Division has used Sourcewell cooperative contract #110921-DEM to acquire a Class II Ambulance/EMT from ambulance vendor Kodiak Emergency Vehicles for a cost not-to-exceed \$192,481.00. Additional supplies needed to outfit the apparatus such as decaling, equipment, medical/safety supplies, etc., will be procured in accordance with the City's purchasing ordinance and policies for an overall cost not-to-exceed \$225,000.00;

The City of Flint has received funding from partial settlement of the National Prescription Opiate Litigation MDL No. 2804. City Administration requests appropriation of available opioid settlement monies to fund this purchase, to establish the capacity to improve medical response for ongoing opioid remediation efforts.

Account #/Grant Code	Description	Amount
288-xxx.xxx-863.900	As designated by Finance Department after City Council approval	\$225,000.00
	FY2024 GRAND TOTAL:	\$225,000.00

IT IS RESOLVED that the Flint City Council appropriates Opioid Settlement funds in an amount not to exceed \$225,000.00, to purchase an ambulance van, accessories and other related equipment. Moneys shall be made available in a fund to be determined by the Finance Department upon Council approval.

IT IS FURTHER RESOLVED that the Flint City Council approves the purchase of ambulance vehicle for a not-to-exceed cost of \$192,481.00, as well as equipment and accessories as described, for total not-to-exceed cost of \$225,000.00. Funding for said purchases will come from the following account:

FOR THE CITY OF FLINT:

CLYDE D EDWARDS
CLYDE D EDWARDS (Mar 12, 2024 18:40 EDT)
Clyde Edwards, City Administrator

APPROVED BY CITY COUNCIL:

CS

APPROVED AS TO FORM:

William Kim
William Kim (Mar 12, 2024 13:54 EDT)
William Kim, City Attorney

APPROVED AS TO FINANCE:

Phillip Moore
Phillip Moore (Mar 12, 2024 13:50 EDT)
Phillip Moore, Chief Finance Officer

APPROVED AS TO PURCHASING:

Lauren Rowley
Lauren Rowley, Purchasing Manager



CITY OF FLINT

STAFF REVIEW FORM

DATE: March 11, 2024

BID/PROPOSAL#

AGENDA ITEM TITLE: In-house Ambulance Service for City of Flint Residents

PREPARED BY: Karen Shim, Flint Fire Department

VENDOR NAME: Kodiak Emergency Vehicles

BACKGROUND/SUMMARY OF PROPOSED ACTION:

To better service the City of Flint residents and community, the Flint Fire Department has determined, because of lack of ambulance transport services, to establish an in-house Ambulance service to assist in the transport of City of Flint residents to emergency facilities in a more timely manner. We utilized Sourcewell cooperative contract #110921-DEM for the Ambulance vendor Kodiak Emergency Vehicles to acquire a Class II Ambulance/EMT for a cost not-to-exceed \$192,481.00. Additional vendors will be procured according to Purchasing Ordinance #3865 for supplies needed to outfit the apparatus such as decaling, equipment, medical/safety supplies, etc. for an overall cost not-to-exceed \$225,000.00. The Administration is requesting the allocation of Opioid Settlement monies to fund this purchase.

FINANCIAL IMPLICATIONS: None

BUDGETED EXPENDITURE? YES [X] NO [] IF NO, PLEASE EXPLAIN:

Funding for said purchases will come from the following account:

Table with 3 columns: Account No /Grant Code, Description, Amount. Row 1: 288-xxx.xxx-863.900, (TBD Upon Council Approval), \$225,000.00. Row 2: FY 2024 GRAND TOTAL: \$225,000.00

PRE-ENCUMBERED? YES [X] NO [] REQUISITION NO: _____

ACCOUNTING APPROVAL: Karen Shim Date: 3/11/2024

WILL YOUR DEPARTMENT NEED A CONTRACT? YES [] NO [X] (If yes, please indicate how many years for the contract) _____YEARS

WHEN APPLICABLE, IF MORE THAN ONE (1) YEAR, PLEASE ESTIMATE TOTAL AMOUNT FOR EACH BUDGET YEAR: (This will depend on the term of the bid proposal)



CITY OF FLINT

BUDGET YEAR 1:

BUDGET YEAR 2:

BUDGET YEAR 3:

OTHER IMPLICATIONS (i.e., collective bargaining):

STAFF RECOMMENDATION: (PLEASE SELECT): **APPROVED** **NOT APPROVED**

DEPARTMENT HEAD SIGNATURE: Theron S. Wiggins
Theron S. Wiggins (Mar 11, 2024 15:30 EDT)

Theron S. Wiggins, Fire Chief



PRESENTED: 7-17-2024

ADOPTED: _____

**Resolution for Approval of a Group E Marihuana Retail –
Adult Use License for CFMJ, LLC
Located at 2926 Robert T. Longway Blvd.**

BY THE CITY ADMINISTRATOR:

WHEREAS, Bruce Leach is the owner/operator of CFMJ, LLC.; and

WHEREAS, CFMJ, LLC has received approval for Group E Marihuana Retail – Adult Use License for this location; and

WHEREAS, Flint City Ordinance 50-80, Marihuana Facilities Ordinance requires that Planning Commission make a recommendation to the City Council for the issuing of a license to the applicant.

IT IS RESOLVED, Pursuant to 50-80.6(A0(2)) that the appropriate City officials are hereby authorized to do all things necessary to issue a license to applicant Bruce Leach of CFMJ, LLC, located at 2926 Robert T. Longway Blvd.

APPROVED AS TO FORM:

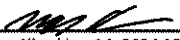

William Kim (Jun 14, 2024 13:39 EDT)
William Kim, City Attorney

ADMINISTRATION:

CLYDE D EDWARDS / A0210
CLYDE D EDWARDS / A0210 (Jun 14, 2024 14:06 EDT)

Clyde D. Edwards, City Administrator

CITY COUNCIL:

City Council



CITY OF FLINT

RESOLUTION STAFF REVIEW FORM

TODAY'S DATE: 5/30/24

BID/PROPOSAL# n/a

AGENDA ITEM TITLE: Resolution for Approval of a Group E Special Regulated Use Marihuana Retail – Adult Use License for CFMJ, LLC (PID # 41-09-303-002).

PREPARED BY: Montel Menifee, Cannabis Facilities Licensing Coordinator

VENDOR NAME: CFMJ, LLC.

BACKGROUND/SUMMARY OF PROPOSED ACTION:

CFMJ, LLC (CEO Bruce Leach) has received approval from the Flint Planning Commission for a Group E Special Regulated Use Permit for an adult-use marihuana retail facility located at 2926 Robert T Longway Blvd. (PID# 41-09-303-002).

Flint City Ordinance 50-80, Marihuana Facilities Ordinance requires that the Planning Commission make a recommendation to the City Council for the issuing of a license to the applicant. In order to be compliant with the ordinance and to make a recommendation to the State of Michigan Licensing and Regulatory Affairs (LARA), it is necessary that City Council approve the license for Bruce Leach’s CFMJ, LLC, located at 2926 Robert T. Longway Blvd.

FINANCIAL IMPLICATIONS: None

BUDGETED EXPENDITURE? YES NO IF NO, PLEASE EXPLAIN: n/a

Dept.	Name of Account	Account Number	Grant Code	Amount
FY 24/25 Grand Total				

PRE-ENCUMBERED? YES NO **REQUISITION NO:** [REDACTED]

WILL YOUR DEPARTMENT NEED A CONTRACT? YES NO
(If yes, please indicate how many years for the contract) YEARS

WHEN APPLICABLE, IF MORE THAN ONE (1) YEAR, PLEASE ESTIMATE TOTAL AMOUNT FOR EACH BUDGET YEAR: (This will depend on the term of the bid proposal) n/a



CITY OF FLINT

BUDGET YEAR 1

BUDGET YEAR 2

BUDGET YEAR 3

OTHER IMPLICATIONS (i.e., collective bargaining): n/a

STAFF RECOMMENDATION: (PLEASE SELECT): **APPROVED** **NOT APPROVED**

DEPARTMENT HEAD SIGNATURE: Montel Meniffee
Montel Meniffee (Jun 14, 2024 13:37 EDT)

Montel Meniffee, Cannabis Facilities Licensing Coordinator

RESOLUTION NO. _____



PRESENTED: 7-17-2024

ADOPTED: _____

**Resolution for Approval of a Group G Special Regulated Use –
Class A Microbusiness for Crooked Ladder, Inc.
Located at 2730 S. Dort Hwy.**

BY THE CITY ADMINISTRATOR:

WHEREAS, John Mcnicol is the owner/operator of Crooked Ladder, Inc.; and

WHEREAS, Crooked Ladder, Inc. has received approval for Group G Special Regulated Use – Class A Microbusiness license for this location; and

WHEREAS, Flint City Ordinance 50-80, Marihuana Facilities Ordinance requires that Planning Commission make a recommendation to the City Council for the issuing of a license to the applicant.

IT IS RESOLVED, Pursuant to 50-80.6(A0(2)) that the appropriate City officials are hereby authorized to do all things necessary to issue a license to applicant John McNicol of Green Buddha, LLC, located at 2730 S. Dort Hwy.

APPROVED AS TO FORM:

William Kim (Jun 14, 2024 15:42 EDT)
William Kim, City Attorney

ADMINISTRATION:

CLYDE D EDWARDS / A0211
CLYDE D EDWARDS / A0211 (Jun 14, 2024 15:50 EDT)
Clyde D. Edwards, City Administrator

CITY COUNCIL:

City Council



CITY OF FLINT

RESOLUTION STAFF REVIEW FORM

TODAY'S DATE: 5/30/24

BID/PROPOSAL# n/a

AGENDA ITEM TITLE: Resolution for Approval of a Group G Special Regulated Use Class A-Marihuana Microbusiness for Crooked Ladder, Inc., (PID # 41-20-278-019).

PREPARED BY: Montel Menifee, Cannabis Facilities Licensing Coordinator

VENDOR NAME: Crooked Ladder, Inc.

BACKGROUND/SUMMARY OF PROPOSED ACTION:

Crooked Ladder, Inc. (CEO John Mcnicol) has received approval from the Flint Planning Commission for a Group G Special Regulated Use Permit for a Class A Microbusiness marihuana facility located at 2730 S. Dort Hwy. (PID# 41-20-278-019).

Flint City Ordinance 50-80, Marihuana Facilities Ordinance requires that the Planning Commission make a recommendation to the City Council for the issuing of a license to the applicant. In order to be compliant with the ordinance and to make a recommendation to the State of Michigan Licensing and Regulatory Affairs (LARA), it is necessary that City Council approve the license for John Mcnicol's, Crooked Ladder, Inc., located at 2730 S. Dort Hwy.

FINANCIAL IMPLICATIONS: None

BUDGETED EXPENDITURE? YES NO IF NO, PLEASE EXPLAIN: n/a

Dept.	Name of Account	Account Number	Grant Code	Amount
FY 24/25 Grand Total				

PRE-ENCUMBERED? YES NO REQUISITION NO: [REDACTED]

WILL YOUR DEPARTMENT NEED A CONTRACT? YES NO
(If yes, please indicate how many years for the contract) YEARS

WHEN APPLICABLE, IF MORE THAN ONE (1) YEAR, PLEASE ESTIMATE TOTAL AMOUNT FOR EACH BUDGET YEAR: (This will depend on the term of the bid proposal) n/a



CITY OF FLINT

BUDGET YEAR 1

BUDGET YEAR 2

BUDGET YEAR 3

OTHER IMPLICATIONS (i.e., collective bargaining): n/a

STAFF RECOMMENDATION: (PLEASE SELECT): **APPROVED** **NOT APPROVED**

DEPARTMENT HEAD SIGNATURE: Montel Menifee
Montel Menifee (Jun 14, 2024 13:54 EDT)

Montel Menifee, Cannabis Facilities Licensing Coordinator

RESOLUTION NO.: _____

240191

ORDINANCE NO. _____

An Ordinance to amend the Flint City Code of Ordinances by amending Chapter 31, General Offenses.

IT IS HEREBY ORDAINED BY THE PEOPLE OF THE CITY OF FLINT:

Sec. 1. An Ordinance to amend the Flint City Code of Ordinances by amending Chapter 31, General Offenses, Article I, In General, by amending Section 31-10, Disorderly Conduct and Disorderly Persons, which shall read in its entirety as follows:

§31-10. DISORDERLY CONDUCT, ASSAULT AND BATTERY, AND DISORDERLY PERSONS.

(A) Disorderly Conduct. Any Person who does any of the following is guilty of a misdemeanor:

- (1) Engages in any fight in a public place, except when doing so in defense of self or another individual;**
- (2) Remains in any public place after its regular closing hours after being told by an authorized person to leave;**
- (3) Conducts himself in any public place, or joins with one or more persons in a public place, and he or she knows or should know that, singly or together with others with whom he or she has joined, is unreasonably obstructing the free and uninterrupted passage of the public along any street or sidewalk. This subsection shall not to be interpreted to conflict with the regulations of the National Labor Relations Board regarding picketing in labor disputes;**
- (4) Persists in disturbing the public peace and quiet by loud or aggressive conduct, after having been clearly informed by Persons affected that he or she is in fact unreasonably causing a disturbance. Notice need not be given when such Persons affected reasonably believe that to do so would constitute a risk to their personal safety;**
- (5) Persists in disturbing the peace and orderly conduct of any meeting of a public body or any meeting open to the general public by any conduct or communication that inflicts injury, tends to incite an immediate breach of peace, or prevents the peaceful and orderly conduct of the meeting after having been clearly informed that he or she is in fact unreasonably causing a disturbance;**
- (6) Knowingly transports any Person, for consideration or the offer of consideration, to a place where prostitution, gambling, or illegal sale of alcoholic Liquor or a Controlled Substance is carried on, for the purpose of enabling the Person to be a customer in any of those activities;**
- (7) Knowingly harasses any other Person. Harass is defined as (i) any repeated nonverbal conduct that is specifically intended to frighten, embarrass, or anger the Person or Persons who are the object of that conduct, (ii) the Person accused has reason to know his or her**

actions will likely produce those reactions, or (iii) any repeated verbal communication that inflicts injury or incites an immediate breach of peace;

(8) Urinates or defecates on any public street or sidewalk, or on the floor of any building open to the public, or any other place in view of the public not specifically designated for that purpose;

(9) Throws any object from any moving vehicle, and he or she knows or should know that damage is likely to result to a person or property, directly or indirectly.

(10) Knowingly destroys, damages, or defaces, or removes any public property or other property not his or her own;

(11) Summons, without good reason, the Police department, Fire Department, any public or private ambulance, or any similar service, to go to any address where the service call is not needed;

(12) Intentionally makes or causes to be made any open exposure of the human male or female genitals, pubic area, buttocks, or female breast in any public place any building open to or frequented by the public, or any other place which is open to the public view;

(13) Makes, aids or assists in making any riot, disturbance, or improper diversion;

(14) Aids or assists in collecting a crowd for any unlawful purpose;

(15) Commits any breach of the peace; or

(16) Loiters, frequents, or remains on or in any public place or private property for the purpose of unlawfully using, possessing, offering sale, selling, furnishing, or dispensing any controlled substance or drug paraphernalia.

(B) Assault and Battery. Any person who:

(1) Assaults or assaults and batters an individual is guilty of a misdemeanor punishable by imprisonment for not more than 93 days or a fine or not more than \$500.00, or both.

(2) Assaults or assaults and batters his or her spouse or former spouse, an individual with whom he or she has or has had a dating relationship, an individual with whom he or she has had a child in common, or a resident or former resident of his or her household, is guilty of a misdemeanor punishable by imprisonment for not more than 93 days or a fine of not more than \$500.00, or both.

(C) THREATS AGAINST LOCAL PUBLIC OFFICIALS: ANY PERSON WHO MAKES A THREAT TO KILL OR PHYSICALLY INJURE ANY PUBLIC OFFICIAL OR CAUSE PROPERTY DAMAGE TO PROPERTY OWNED BY A PUBLIC OFFICIAL IS GUILTY OF A MISDEMEANOR.

(D) As used in this section:

(1) *Controlled substance* shall have the same meaning as in §31-22.

(2) *Drug paraphernalia* shall have the same meaning as in §31-22.

(3) *Dating relationship* means frequent, intimate associations primarily characterized by the expectation of affectional involvement. This term does not include a casual relationship or an ordinary fraternization between 2 individuals in a business or social context.

(4) **LOCAL PUBLIC OFFICIAL MEANS AN ELECTED OR APPOINTED OFFICIAL OR EMPLOYEE OF A LOCAL UNIT OF GOVERNMENT.**

(5) **THREAT MEANS THE EXPRESSION OF AN INTENT TO COMMIT AN ACT OF UNLAWFUL VIOLENCE TO A PARTICULAR INDIVIDUAL, INDIVIDUALS, OR THEIR PROPERTY, WITHOUT REGARD AS TO WHETHER THE MAKER OF THE THREAT ACTUALLY INTENDS TO CARRY OUT THE THREAT.**

Sec. 2. This Ordinance shall become effective 30 days after enactment.

Adopted this ____ day of _____, 2024.

FOR THE CITY:

For the City Council

Sheldon A. Neeley, Mayor

APPROVED AS TO FORM:

240192

ORDINANCE NO. _____

An Ordinance to amend Chapter 46, Utilities, Article II, Water Supply and Sewage Disposal System, of the Flint City Code of Ordinances, by the addition of Division 5, Replacement of Lead Service Lines.

IT IS HEREBY ORDAINED BY THE PEOPLE OF THE CITY OF FLINT:

Sec. 1. An Ordinance to amend Chapter 46, Utilities, Article II, Water Supply and Sewage Disposal System, by the addition of Division 5, Replacement of Lead Service Lines, which shall read in its entirety:

DIVISION 5: REPLACEMENT OF LEAD SERVICE LINES

§46-75. Purpose and Definitions.

- (a) Purpose. The purpose of this ordinance is to provide for the removal and replacement of all lead service lines in the City of Flint.
- (b) Definitions. As used in this ordinance the following words shall have the following meaning:
 - (1) *Service Line* shall mean the pipe or conduit located on a parcel of property which connects any building, dwelling or structure in the City of Flint to the City of Flint's public water distribution system.
 - (a) The *private side* of a service line shall mean that portion of the service line which extends from the building, dwelling or structure to the beginning of a public right of way.
 - (b) The *public side* of a service line shall mean that portion of the service line which extends on, under or through a public right of way.
 - (2) *Lead Service Line* shall mean a service line that is made of lead or galvanized steel.
 - (3) *Owner* shall mean any person or entity which holds legal or equitable title to any parcel of property in the City of Flint upon which a service line is located. The term *Owner* shall include the executor, trustee, guardian or receiver of an estate or trust which holds legal or equitable title to a parcel of property, including a mortgagee or vendee in possession.

§46-76. Lead Service Lines Declared a Public Nuisance, Replacement

- (a) The existence of a lead service line or lines in the City of Flint is declared a public nuisance and may be abated as provided by law.

- (b) The absence of City records indicating that the service line was inspected and/or replaced after 2015 at any given property shall create a rebuttable presumption that a lead service line exists at that property.
- (c) The owner of the property upon which the lead service line is located shall be responsible for determining how the lead service line will be replaced.
- (d) A lead service line may be replaced at no expense to the owner of the property under the Lead Service Line Replacement Program as described in §46-77 of this ordinance.
- (e) An owner who does not wish to participate in the Lead Service Line Replacement Program shall arrange to have a licensed plumber or other qualified service provider replace the lead service line within one year of the effective date of this ordinance.
- (f) The City of Flint shall not be required to reimburse an owner who does not wish to participate in the Lead Service Line Replacement Program for any cost or expense associated with replacing the lead service line.

§ 46-77. Lead Service Line Replacement Program

- (a) A Lead Service Line Replacement Program shall be managed by the City of Flint Department of Public Works.
- (b) The Lead Service Line Replacement Program shall replace any lead service line in the City of Flint, at no expense to the owner of the property, on a schedule to be determined by the City.
- (c) To participate in the Lead Service Line Replacement Program, an owner must:
 - (1) Register with the City of Flint Department of Public Works in a form acceptable to the Department of Public Works;
 - (2) Grant the agents, employees and/or contractors of the City of Flint, permission to enter the property upon which the lead service line is located or believed to be located, during any daylight hours, for the purpose of replacing the lead service line.
- (d) An owner who does not participate in the Lead Service Line Replacement Program shall provide the City of Flint Department of Public Works with the following documentation to prove the private side of a lead service line has been replaced:
 - (1) The name, address and telephone number of the licensed plumber or other qualified service provider that replaced the private side of the lead service line; and
 - (2) An invoice, receipt, or other documentation showing that the private side of the lead service line has been replaced, the prior service line composition, and on what date the replacement occurred.
- (e) The deadlines of this division may be extended by the City of Flint Department of Public Works for good cause.

§ 46-78. Violation and Remedies

- (a) An owner who fails to comply with the provisions of this ordinance, and/or who fails to cause or arrange for the removal of a lead service line from the owner's property, shall be responsible for a municipal civil infraction as provided under § 1-13 to § 1-20 of the Flint City Code of Ordinances.
- (b) The City attorney for the City of Flint may maintain any action to enforce the provisions of this ordinance.
- (c) Any person who violates the provisions of this ordinance shall also be liable for the costs of this action, including a reasonable attorneys' fee.

Sec. 2. This Ordinance shall become effective 30 days after enactment.

Adopted this ___ day of _____, 2024.

FOR THE CITY:

For the City Council

Sheldon A. Neeley, Mayor

APPROVED AS TO FORM:

240261

ORDINANCE NO. _____

An Ordinance to amend the Flint City Code of Ordinances by amending Chapter 50, Zoning, Article XXX, Flood Hazard Management.

IT IS HEREBY ORDAINED BY THE PEOPLE OF THE CITY OF FLINT:

Sec. 1. An Ordinance to amend the Flint City Code of Ordinances by amending Chapter 50, Zoning, Article XXX, Flood Hazard Management, by amending Section 50-172, Flood Insurance Study Adopted, which shall read in its entirety as follows:

§50-172. FLOOD INSURANCE STUDY ADOPTED.

The areas of special flood hazard identified by the Federal Insurance Administration in a scientific and engineering report entitled *The Flood Insurance Study for the City of Flint, 1980* with accompanying flood insurance rate maps dated September 25, 2009 are hereby adopted by reference and declared to be a part of this article. The flood insurance study is on file in the City Clerk's office of the City.

Sec. 2. This Ordinance shall become effective 30 days after enactment.

Adopted this ___ day of _____, 2024.

FOR THE CITY:

For the City Council

Sheldon A. Neeley, Mayor

APPROVED AS TO FORM:

William Kim, City Attorney

240264

ORDINANCE NO. _____

An Ordinance to amend Chapter 50 of the Flint City Code of Ordinances by amending Section 50-200, Authority of the Zoning Coordinator; and to amend Chapter 50 of the Flint City Code of Ordinances by amending Section 50-202, Enforcement Powers.

IT IS HEREBY ORDAINED BY THE PEOPLE OF THE CITY OF FLINT:

Sec. 1. An Ordinance to amend the Flint City Code of Ordinances by amending Chapter 50, Zoning, Article 18, Administration and Enforcement, Section 50-200, Authority of the Zoning Coordinator; and to amend the Flint City Code of Ordinances by amending Chapter 50, Zoning, Article 18, Administration and Enforcement, Section 50-202, Enforcement Powers, which shall read in its entirety:

§ 50-200 Authority of the Zoning Coordinator

(A.) Authority of the Zoning Coordinator. The administration of the Chapter, and the interpretation of the provisions of this Chapter, shall be the responsibility of the Zoning Coordinator, or another designee of the Director of Planning and Development if the Zoning Coordinator position is vacant.

(B.) Code Enforcement Responsibility. The enforcement of this Chapter shall be the responsibility of the Zoning Coordinator and, staff designated by the Zoning Coordinator, THE BUILDING OFFICIAL, AND STAFF DESIGNATED BY THE BUILDING OFFICIAL.

(C.) Lapse in Permitting or Enforcement. No oversight or dereliction on the part of the Zoning Coordinator shall legalize, authorize, waive or excuse the violation of any of the provisions of this Chapter. No permit, nor any license for any use, building or purpose shall be issued by any official or employee of the City if the same would be in conflict with the provisions of this Chapter. Any permit or license so issued shall be null and void.

(D.) Appeals Regarding Enforcement. All appeals to decisions made by the Zoning Coordinator or appointee are subject to the procedures contained in Article 17.

§ 50-202 Enforcement Powers

The city may use any lawful remedy or enforcement powers against the owner or responsible person for any violation of this Chapter, including, without limitation, one or more of the following. Remedies may be pursued simultaneously or sequentially and the pursuit of one remedy does not foreclose the simultaneous or subsequent pursuit of other remedies. The remedies are cumulative and the City shall have all power granted from time to time under all applicable federal, state and local laws, rules and regulations:

(A.) Withhold Permit. The City may deny or withhold any and all permits or other forms of authorization from an applicant on any property where there is an uncorrected violation of a provision of this Chapter or of a condition or stipulation of approval for a permit or other authorization previously granted by the City. This enforcement provision shall apply regardless of whether the current owner or applicant is responsible for the violation in question.

(B.) Permit Approved with Conditions. In addition to denying or withholding a permit or other authorization, the City may grant such permit or other authorization subject to the condition that the violation be corrected.

(C.) Revoke Permit. A permit or other form of authorization authorized under this chapter may be revoked when the Zoning Coordinator determines that: a) there is departure from the plans, specifications, or conditions required under the permit; b) the permit or other form of authorization was procured by false representation or was issued in error; or c) any of the provisions of this chapter are being violated. Any permit or other authorization revoked under this procedure shall become null and void.

(D.) Cease and Desist Order. With or without revoking a permit, the Zoning Coordinator may issue a cease and desist order on any land, building or structure for which there is an uncorrected violation of a provision of this Chapter. The cease and desist order must be in writing and must state the work in violation that is to be stopped, the reasons for the stoppage, and the conditions under which the work may be resumed.

(E.) Court Order. The City Attorney may bring and prosecute an action in any court of competent jurisdiction to: a) enjoin the owner or responsible person from continuing such use, erection, construction, moving or alteration; or if such is being or has been accomplished, the City Attorney shall enjoin the owner or responsible person from maintaining the same; and/or b) comply with the requirements of this Chapter.

(F.) Declaration of Nuisance. A violation of this Chapter is a nuisance per se and the City may institute appropriate actions or court proceedings to correct, or abate any violation of the provisions of this Chapter. If the owner or responsible person fails to abate a violation, the City may take action to abate the violation. The abatement may be performed by the City, by a contract vendor, or by other means determined by the City. The cost of such action, plus an administrative fee, shall be a personal debt of the owner, and may be assessed as a lien against the property until paid.

(G.) Performance Guarantee or Surety. If a performance guarantee or surety was previously required as a special condition by the Planning Commission, Zoning Board of Appeals, City Council, or Zoning Coordinator, the City may seek forfeiture of the performance guarantee or surety.

(H.) MUNICIPAL CIVIL INFRACTION. A VIOLATION OF THIS CHAPTER SHALL BE A MUNICIPAL CIVIL INFRACTION PURSUANT TO AND PUNISHABLE BY § 1-10 THROUGH § 1-21 OF THE FLINT CITY CODE OF ORDINANCES. THOSE PERSONS IDENTIFIED IN § 50-200 (B) MAY ISSUE A MUNICIPAL CIVIL INFRACTION FOR A VIOLATION OF THIS CHAPTER.

Sec. 2. This Ordinance shall become effective this ____ day of _____, 2024, A.D.

Adopted this ____ day of _____, 2024, A.D.

FOR THE CITY:

For the City Council

Sheldon A. Neeley, Mayor

APPROVED AS TO FORM:

William Kim, City Attorney

ORDINANCE AMENDMENT STAFF REVIEW

TODAY'S DATE: June 5, 2024

BID/PROPOSAL# n/a

AGENDA ITEM TITLE: An Ordinance to amend Chapter 50 of the Flint City Code of Ordinances by amending Section 50-200, Authority of the Zoning Coordinator; and to amend Chapter 50 of the Flint City Code of Ordinances by amending Section 50-202, Enforcement Powers.

PREPARED BY: Emily Doerr, Director of Business and Community Services (formerly known as Planning and Development)

VENDOR NAME: n/a

BACKGROUND/SUMMARY OF PROPOSED ACTION:

The City of Flint Planning Commission conducted a public hearing on April 9th, 2024 regarding potential updates to Article 18: Administration and Enforcement to add an additional enforcement option and clearly define additional staff with enforcement capabilities. Staff worked with the Legal Department to draft these changes and they have been approved for review and potential adoption.

The first proposed change would clearly denote the Building Official and their designated staff as having the authority to enforce the Zoning Ordinance, as was permitted under the prior Zoning Ordinance. The overall impact is not significant as the Zoning Coordinator can designate staff, however, it would more clearly allow the Building Official to designate their staff such as the Neighborhood Enforcement Officers.

The second proposed change would add additional language allowing enforcement staff to issue a municipal civil infraction, in addition to the other enforcement powers noted in Section 50-202. Sections 1-10 through 1-21 are attached, these sections define the process, fines, and penalties for a municipal civil infraction and subsequent violations. The benefit of this process is that it avoids a respondent having to secure legal representation, rather settling the matter in a more informal court setting.

PREVIOUS ALLOCATIONS (INCLUDE ALL ACCOUNTS USED FOR THIS PURPOSE)/ PROVIDE RESOLUTION OR CONTRACT INFORMATION THAT APPLIES: n/a

POSSIBLE BENEFIT TO THE CITY OF FLINT (RESIDENTS AND/OR CITY OPERATIONS) INCLUDE PARTNERSHIPS AND COLLABORATIONS:

These ordinance amendments will allow for city staff to take action ensuring that land use regulations dictated by the Comprehensive Plan, the Zoning Ordinance, and decisions made by the Planning Commission and Zoning Board of Appeals can actually be enforced.

FINANCIAL IMPLICATIONS: This could possibly lead to increased revenue for the city from increased fees and penalties paid from increased municipal civil infractions.

BUDGETED EXPENDITURE? YES NO **IF NO, PLEASE EXPLAIN:** n/a

Dept.	Name of Account	Account Number	Grant Code	Amount
		Not applicable		
		FY24 GRAND TOTAL		

PRE-ENCUMBERED? YES NO **REQUISITION NO:** n/a

ACCOUNTING APPROVAL: _____ **Date:** _____

WILL YOUR DEPARTMENT NEED A CONTRACT? YES NO

WHEN APPLICABLE, IF MORE THAN ONE (1) YEAR, PLEASE ESTIMATE TOTAL AMOUNT FOR EACH BUDGET YEAR: (This will depend on the term of the bid proposal)

BUDGET YEAR 1

BUDGET YEAR 2

BUDGET YEAR 3

OTHER IMPLICATIONS (i.e., collective bargaining):

STAFF RECOMMENDATION: (PLEASE SELECT): **APPROVED** **NOT APPROVED**

DEPARTMENT HEAD SIGNATURE:



Emily Doerr (Jun 10, 2024 14:47 EDT)

Emily Doerr, Director, Business and Community Services



CITY OF FLINT
Department of Business and Community Services
Planning and Zoning Division

Sheldon Neeley,
Mayor

Memorandum

Date: March 25th, 2024
To: City of Flint Planning Commission
From: Max Lester, Int. Zoning Coordinator
Subject: Details of Proposed Article 18: Administration and Enforcement Text Amendments

Commissioners,

At the march 12th, 2024 meeting staff requested a Public Hearing be set to discuss potential updates to Article 18: Administration and Enforcement to add an additional enforcement option and clearly define additional staff with enforcement capabilities. Below is an explanation of the recommended changes in the attached draft documents. Changes are noted with highlighted text. Staff worked with the Legal Department to draft these changes and they have been approved for review and potential adoption.

Relevant Sections of the Zoning Ordinance:

Article 18: Administration and Enforcement
Section 50-200 B. Code Enforcement Responsibility
Section 50-202 Enforcement Powers

Draft Amended Sections and Explanations:

Section 50-200 B. Code Enforcement Responsibility

Code Enforcement Responsibility. The enforcement of this Chapter shall be the responsibility of the Zoning Coordinator, staff designated by the Zoning Coordinator, the Building Official, and staff designated by the Building Official.

The proposed change would clearly denote the Building Official and their designated staff as having the authority to enforce the Zoning Ordinance, as was permitted under the prior Zoning Ordinance. The overall impact is not significant as the Zoning Coordinator can designate staff, however, it would more clearly allow the Building Official to designate their staff such as the Neighborhood Enforcement Officers.

Section 50-202 Enforcement Powers / 50-202 H. Municipal Civil Infraction

Municipal Civil Infraction. A violation of this Chapter shall be a municipal civil infraction pursuant to and punishable by § 1-10 through § 1-21 of the Flint City Code of Ordinances. Those Persons identified in § 50-200 (B) may issue a municipal civil infraction for a violation of this Chapter.

The proposed addition would allow enforcement staff to issue a municipal civil infraction, in addition to the other enforcement powers noted in Section 50-202. Sections 1-10 through 1-21 are attached, these sections define the process, fines, and penalties for a municipal civil infraction and subsequent violations. The benefit of this process is that it avoids a respondent from having to secure legal representation, rather settling the matter in a more informal court setting.

Attached:

Current and Amended Article 18: Administration and Enforcement
Draft Amended Zoning Ordinance Sections 50-200 and 50-202
Sections 1-10 through 1-21 of the Flint City Code of Ordinances.

Page left intentionally blank.

ARTICLE 18 ADMINISTRATION AND ENFORCEMENT

Table of Contents

Section 50-200 Authority of the Zoning Coordinator	1
Section 50-201 Violations	1
Section 50-202 Enforcement Powers.....	2
Section 50-203 Enforcement Process	3

Section 50-200 Authority of the Zoning Coordinator

- A. Authority of the Zoning Coordinator. The administration of the Chapter, and the interpretation of the provisions of this Chapter, shall be the responsibility of the Zoning Coordinator, or another designee of the Director of Planning and Development if the Zoning Coordinator position is vacant.
- B. Code Enforcement Responsibility. The enforcement of this Chapter shall be the responsibility of the Zoning Coordinator, staff designated by the Zoning Coordinator, the Building Official, and staff designated by the Building Official.
- C. Lapse in Permitting or Enforcement. No oversight or dereliction on the part of the Zoning Coordinator shall legalize, authorize, waive or excuse the violation of any of the provisions of this Chapter. No permit, nor any license for any use, building or purpose shall be issued by any official or employee of the City if the same would be in conflict with the provisions of this Chapter. Any permit or license so issued shall be null and void.
- D. Appeals Regarding Enforcement. All appeals to decisions made by the Zoning Coordinator or appointee are subject to the procedures contained in Article 17.

Section 50-201 Violations

All land developed or redeveloped, all buildings and structures erected, converted, enlarged, reconstructed, moved or structurally altered, and all land, buildings, structures, and uses must comply with all applicable provisions of this Chapter. Failure to comply with applicable provisions constitutes a violation of this Chapter. The following list of violations is intended to be illustrative, and not limited to the specific items.

- A. Development or Redevelopment Violations.
 - a. Engaging in the development or redevelopment of land in any way not consistent with the requirements of this Chapter.
 - b. Erecting a building or other structure in any way not consistent with the requirements of this Chapter.
 - c. Failure to comply with any condition or stipulation imposed on a permit or approval, including conditions of approval for a change in zoning, Special Use, Site Plan Review, Variance, Planned Unit Development, or other approval.

- B. Alterations to Existing Land, Buildings or Structures Violations.
 - a. Modifying, converting, filling, excavating, removing, enlarging, reconstructing, moving or structurally altering land, vegetation, fences, and other site features in any way except as permitted by or pursuant to this Chapter.
 - b. Modifying, converting, enlarging, reconstructing, demolishing, moving or structurally altering an existing building or structure except as permitted by or pursuant to this Chapter.
- C. Use Violations.
 - a. Using land, buildings or structures in any way except as permitted by or pursuant to this Chapter.
 - b. Engaging in the use of a building or land or any other activity requiring one or more permits, variance or other approval under this Chapter without obtaining all such permits, variances or approvals.
- D. Compliance Violations.
 - a. Failure to comply with any lawful order issued by the Zoning Coordinator.
 - b. Failure to arrange for an initial inspection or a re-inspection to determine compliance with notices issued under this Chapter.
 - c. Failure to comply with any permit, variance, special use, planned development, or approval granted under this Chapter.
- E. Separate Violation. Each act of violation and each day upon which a violation occurs or remains shall constitute a separate violation.

Section 50-202 Enforcement Powers

The City may use any lawful remedy or enforcement powers against the owner or responsible person for any violation of this Chapter, including, without limitation, one or more of the following. Remedies may be pursued simultaneously or sequentially and the pursuit of one remedy does not foreclose the simultaneous or subsequent pursuit of other remedies. The remedies are cumulative and the City shall have all power granted from time to time under all applicable federal, state and local laws, rules and regulations:

- A. **Withhold Permit.** The City may deny or withhold any and all permits or other forms of authorization from an applicant on any property where there is an uncorrected violation of a provision of this Chapter or of a condition or stipulation of approval for a permit or other authorization previously granted by the City. This enforcement provision shall apply regardless of whether the current owner or applicant is responsible for the violation in question.
- B. **Permit Approved with Conditions.** In addition to denying or withholding a permit or other authorization, the City may grant such permit or other authorization subject to the condition that the violation be corrected.
- C. **Revoke Permit.** A permit or other form of authorization authorized under this Chapter may be revoked when the Zoning Coordinator determines that: a) there is departure from the plans, specifications, or conditions required under the permit; b) the permit or other form of authorization was procured by false representation or was issued in error; or c) any of the provisions of this Chapter are being violated. Any permit or other authorization revoked under this procedure shall become null and void.

- D. **Cease and Desist Order.** With or without revoking a permit, the Zoning Coordinator may issue a cease and desist order on any land, building or structure for which there is an uncorrected violation of a provision of this Chapter. The cease and desist order must be in writing and must state the work in violation that is to be stopped, the reasons for the stoppage, and the conditions under which the work may be resumed.
- E. **Court Order.** The City Attorney may bring and prosecute an action in any court of competent jurisdiction to: a) enjoin the owner or responsible person from continuing such use, erection, construction, moving or alteration; or if such is being or has been accomplished, the City Attorney shall enjoin the owner or responsible person from maintaining the same; and/or b) comply with the requirements of this Chapter.
- F. **Declaration of Nuisance.** A violation of this Chapter is a nuisance per se and the City may institute appropriate actions or court proceedings to correct, or abate any violation of the provisions of this Chapter. If the owner or responsible person fails to abate a violation, the City may take action to abate the violation. The abatement may be performed by the City, by a contract vendor, or by other means determined by the City. The cost of such action, plus an administrative fee, shall be a personal debt of the owner, and may be assessed as a lien against the property until paid.
- G. **Performance Guarantee or Surety.** If a performance guarantee or surety was previously required as a special condition by the Planning Commission, Zoning Board of Appeals, City Council, or Zoning Coordinator, the City may seek forfeiture of the performance guarantee or surety.
- H. **Municipal Civil Infraction.** A violation of this Chapter shall be a municipal civil infraction pursuant to and punishable by § 1-10 through § 1-21 of the Flint City Code of Ordinances. Those Persons identified in § 50-200 B. may issue a municipal civil infraction for a violation of this Chapter.

Section 50-203 Enforcement Process

- A. **Basis of Inspections.** Inspections shall be made to obtain and maintain compliance with the provision of this Chapter based upon one (1) or more of the following:
 - a. To determine conformity with a permit, variance or other approval, as well as any special conditions imposed at any time.
 - b. The need to determine compliance with a notice or an order issued by the City.
 - c. A complaint is received by the City, indicating that there is a violation of the provisions of this Chapter.
 - d. An observation by the City of a violation of the provisions of this Chapter.
 - e. An emergency is observed or reasonably believed to exist.
 - f. A request for an inspection is made by the owner or responsible person.
 - g. Designation of an area where all dwellings, accessory building, yards, and/or signs are to be inspected uniformly or intensively or for specific violations.
- B. **Content of Written Notices.** Notices authorized by this Chapter shall:
 - a. Be in writing.
 - b. Include a description of the real estate and/or project name sufficient for identification.
 - c. Include a statement of the violation or violations.

- d. Include a correction order allowing a reasonable time to correct the violation and bring the property into compliance. If a Notice to Abate, the notice shall indicate that the City may act to abate the violation if not brought into compliance.
 - e. State that failure to comply with the Notice may result in further enforcement action.
 - f. State that a fee shall be charged for the issuance of the Notice. If a Notice to Abate, the cost of City action to abate the violation shall be a personal debt of the owner, which may be assessed as a lien against the property until paid.
 - g. Include a description of the right to appeal, as applicable.
- C. Method of Service. A written notice shall be deemed to be properly served in one (1) of the following ways:
- a. Delivered personally,
 - b. Sent by first-class mail addressed to the last known address of the responsible person, or
 - c. Any other method authorized for the service of process by court rule or State statute.
- D. Posting. After issuing a written notice, the City may, but is not required to, post a copy of the written notice and/or a placard on the property.
- E. Reasonable Entry. If needed, inspections inside a structure, building, dwelling, dwelling unit or accessory building shall be made during reasonable hours. Entry without consent of an owner or an occupant shall require an order of the court as provided by State law.

§ 1-10 APPEARANCE TICKETS.

(a) Officers, employees and other individuals employed by and in the service of the City who are authorized by State law and Flint City Code § 1-8 and § 1-9 to enforce the provisions of this Code, are hereby specifically authorized in accordance with State law, to issue and serve upon a person an appearance ticket. This authorization is contingent upon the authorizing person having reasonable cause to believe that a person has committed a violation of this Code. This authorization is not granted where the issuance of such an appearance ticket is expressly prohibited by the provisions of this Code or applicable State law.

(b) An "appearance ticket" as that term is used in subsection (a) means a complaint, municipal civil infraction or written notice issued and subscribed by a police officer or other authorized person as defined in subsection (a) which directs a person to appear in the local District Court at a designated future date and time in connection with the alleged commission of a violation of this Code for which the maximum permissible penalty does not exceed ninety-three (93) days in jail and/or a fine of five hundred dollars (\$500.00). The appearance ticket shall be numbered consecutively, be in such form authorized by the State Court Administrator and shall consist of the following parts:

- (1) The original, which shall be a complaint or notice to appear by the authorized person, shall be filed with the court;
- (2) The first copy shall be an abstract of court records retained by the court;
- (3) The second copy shall be retained by the appropriate local enforcement agency;
- (4) The third copy shall be issued to the alleged violator.

(c) With the prior approval of the State Court Administrator, the appearance ticket may be appropriately modified as to content or number of copies to accommodate the law enforcement agency and local court procedures and practices.

(Ord. 3285, passed 11-28-1994; Ord. 3535, passed 6-9-2004)

§ 1-11 PRESUMPTION OF MISDEMEANOR.

Unless a violation of this Code is specifically designated in the text of this Code to be a civil infraction, a violation shall be deemed to be a misdemeanor.

(Ord. 3285, passed 11-28-1994; Ord. 3536, passed 6-9-2004)

§ 1-12 DEFINITIONS.

The following words and phrases as used in this article, unless a different meaning is clearly required by the context, shall have the following meanings.

AUTHORIZED LOCAL OFFICIAL. A police officer or other personnel of the city authorized to issue municipal civil infraction notices and/or citations.

BUREAU. The Municipal Ordinance Violations Bureau established by § 1-15.

MUNICIPAL CIVIL INFRACTION. A violation of a provision of this Code for which the remedy and/or penalty is prescribed to be a civil fine, or sanction other than a criminal penalty. A **MUNICIPAL CIVIL INFRACTION** is not a lesser included offense of a criminal offense or of an ordinance violation that is not a civil infraction.

MUNICIPAL CIVIL INFRACTION CITATION. A written complaint or appearance ticket prepared by an authorized person directing a person to appear in court regarding the occurrence or existence of a municipal civil infraction violation by that person.

MUNICIPAL CIVIL INFRACTION DETERMINATION. A finding that a defendant is responsible for a municipal civil infraction by one of the following:

- (1) An admission of responsibility for the municipal civil infraction.
- (2) An admission of responsibility for the municipal civil infraction, "with explanation."
- (3) A preponderance of the evidence at an informal hearing or formal hearing.
- (4) A default judgment for failing to appear at a scheduled appearance.

MUNICIPAL CIVIL INFRACTION VIOLATION NOTICE. A written notice prepared by an authorized person, directing a person to appear at the Municipal Ordinance Violations Bureau for the purpose of paying a civil fine and/or costs for a violation which is prescribed to be a municipal civil infraction.

REPEAT OFFENSE. A determination of responsibility for a second, or any subsequent municipal civil infraction after there has already been a determination of responsibility with regard to the same Code provision committed by the same person within the past three years, unless some other period is specifically provided with regard to a specific Code provision.

RESPONSIBLE or RESPONSIBILITY. A determination entered by a court or magistrate that a person is in violation of a provision of this Code prescribed to be a municipal civil infraction.

VIOLATION. Any act which is prohibited or made or declared to be unlawful or an offense under this Code, including affirmative acts as well as omissions and/or failures to act where the act is required by this Code.

(Ord. 3285, passed 11-28-1994; Ord. 3537, passed 6-9-2004; Ord. 3645, passed 4-25-2005)

§ 1-13 COMMENCEMENT OF MUNICIPAL CIVIL INFRACTION ACTION.

(a) A municipal civil infraction action may be commenced upon the issuance, by an authorized local official, of either of the following:

- (1) A municipal civil infraction citation directing the person alleged to be responsible to appear in court;
- (2) A municipal civil infraction notice directing the alleged violator to appear at the Municipal Violations Bureau.

(b) The form of citations or notices used to charge municipal civil infraction violations shall be in accordance with State law, shall name the City of Flint as the plaintiff and for municipal civil infraction citations and shall give a reasonable time after the citation is issued for appearance at the 68th District Court.

(c) The basis for issuance of a municipal civil infraction citation or notice shall be as set forth below:

- (1) An authorized local official witnesses a person violate an ordinance, the violation of which is a municipal civil infraction.
- (2) An authorized local official may issue a citation or notice to a person if, based upon investigation, the authorized person has reasonable cause to believe that a person is responsible for a municipal civil infraction.

a. For violations concerning the use, occupation or condition of rental property both the landlord and tenant may be issued a municipal civil infraction, in accordance with subsection (d), for the same offense concerning the use, occupation or condition of the property and shall be individually responsible for a violation of same.

(3) An authorized local official may issue a citation or notice to a person if, based upon investigation of a complaint by someone who allegedly witnessed the person violate an ordinance, a violation of which is a municipal civil infraction, the authorized local official has reasonable cause to believe that the person is responsible for a municipal civil infraction and if the attorney for the City approves in writing the issuance of the citation or notice.

(d) Municipal civil infraction citations or notices shall be served in the following manner.

(1) Except as otherwise provided below, the authorized local official shall personally serve a copy of the citation or notice upon the alleged violator.

(2) In a municipal civil infraction action involving the use or occupancy of land or a building or other structure, a copy of the citation or notice need not be personally served upon the alleged violator but may be served upon an owner and/or occupant of the land, building or structure by posting the copy on the land or attaching the copy to the building or structure. In addition, a copy of the citation or notice shall be sent by first class mail to the owner of the land, building or structure at the owner's last known address.

a. In cases involving properly licensed rental property, where a citation is issued to a tenant, in addition to posting, a copy of the notice shall be sent by first class mail to both the owner and the tenant of the property.

(3) A citation or notice served as provided in subsection(2) above, for a violation involving the use or occupancy of land or a building or other structure, shall be processed in the same manner as a citation or notice served personally upon a defendant.

(4) The copies of the citation shall be distributed as follows:

- a. The original citation which is a complaint and notice to appear by the authorized local official shall be filed with the 68th District Court.
- b. The first copy shall be an abstract of the court and retained by the court.
- c. Second copy shall be retained by the authorized local official.
- d. The third copy shall be issued to the alleged violator.

(5) A citation for a municipal civil infraction signed by an authorized local official shall be treated as made under oath if the authorized local official signing and dating the complaint does so immediately above the following statement "I declare under the penalties of perjury that the statements above are true to the best of my knowledge, information and belief."

(6) Each citation shall inform the defendant that he or she may do one of the following:

a. Admit responsibility for municipal civil infraction by mail, in person, or by representation, at or by the time specified for appearance.

b. Admit responsibility with explanation by mail by the time specified for appearance, or in person, or by representation. If the defendant is going to admit responsibility with explanation either in person or by representation, the defendant must apply to the court in person, by mail, by telephone or by representation within the time specified for appearance and obtain a scheduled date and time for appearance. If the defendant admits responsibility with explanation by mail, the court shall accept the admission as though the defendant has admitted responsibility under subsection (d)(6)a. above and the court may consider the defendant's explanation by way of mitigating any sanction that the court may order. If the appearance is made by mail or representation the court shall accept the admission of responsibility but may also require the defendant to provide further explanation or to appear in court.

c. Deny responsibility for the municipal civil infraction by doing the following:

1. Appearing in person for an informal hearing before a judge or district court magistrate, without the opportunity of being represented by an attorney, unless a formal hearing before a judge is requested by the plaintiff.

2. Appearing in court for a formal hearing before a judge, with the opportunity of being represented by an attorney.

3. Defendant must apply in person, by mail, by telephone or by representation with the time specified for appearance and obtain a scheduled date and time to appear for a hearing.

4. The hearing shall be an informal hearing unless a formal hearing is requested by either the plaintiff or the defendant.

(7) The citation shall contain in boldface type that the failure of a defendant to appear within the time specified in the citation or a time scheduled for a hearing or appearance is a misdemeanor and will result in the entry of a default judgment against the defendant on the municipal infraction. Return of the citation with an admission of responsibility and with full payment of fines and costs, return of the citation with an admission of responsibility with explanation, or timely application to the court for a scheduled date and time for appearance or hearing constitutes a timely appearance.

(8) If a hearing is scheduled, it shall be an informal hearing, unless a formal hearing is requested by the plaintiff or defendant and a confirming notice shall be mailed by the court to the defendant to the address appearing on the citation or supplied by the defendant. An informal hearing shall be conducted pursuant to MCLA § 600.8719 and a formal hearing shall be conducted pursuant to MCLA § 600.8721.

(9) The court shall schedule a formal hearing if either the plaintiff or the defendant expressly requests a formal hearing. The request for a formal hearing must be received at least 10 days before any hearing date appearing on the citation. The party requesting the formal hearing shall notify the other party of the request and must be received by the party at least 10 days before the hearing date. A formal hearing may be requested in person, by representation, by mail or by telephone. Witness fees need not be paid in advance to a witness. Witness fees for a witness on behalf of the plaintiff are payable by the District Control Unit of the District Court for the City of Flint. There shall be no jury trial for a municipal civil infraction.

(10) If the defendant fails to appear as directed by the citation or other notice at a scheduled appearance, at a scheduled informal hearing, or at a scheduled formal hearing a default judgment shall be entered. A defendant who fails to answer a citation or notice to appear in court for a municipal civil infraction is guilty of a misdemeanor.

(Ord. 3285, adopted 11-28-1994; Ord. 3538, passed 6-9-2004; Ord. 3646, passed 4-25-2005; Ord. 3652, passed 6-27-2005)

§ 1-14 ORDINANCE ENFORCEMENT OFFICER.

(a) Pursuant to §§ 1-7 and 1-8 ordinance enforcement officers may be appointed for purposes of carrying out the duties and responsibilities specified in this Code for authorized persons charged with the enforcement of this Code.

(b) An appointed ordinance enforcement officer is authorized to enforce all provisions of this Code, whether or not any particular provision specifies or designates a different enforcing official. Where a particular officer is designated in any Code provision, that officer's authority shall continue in full force and effect, and shall not be diminished or impaired by the terms of this section, and the authority of the ordinance enforcement officer shall be in addition and supplementary to the authority granted to such other specific officer.

(c) The ordinance enforcement officer's duties shall include the following: investigation of Code violations; issuance and service of municipal ordinance violation notices and municipal civil infraction citations and municipal civil infraction violation notices; appearance in court or other judicial or quasi-judicial proceedings in the administration of this Code.

(Ord. 3285, adopted 11-28-1994; Ord. 3539, passed 6-9-2004)

§ 1-15 ESTABLISHMENT OF BUREAU.

(a) A City Municipal Civil Infraction Violation Bureau is hereby established for the purpose of accepting admissions of responsibility in response to municipal civil infraction violation notices.

(b) Payments made to the Bureau shall be retained and accounted for as fines and costs, respectively, and shall be deposited in the general fund.

(c) The Bureau shall be at locations designated by the Chief Legal Officer. All employees of the Bureau shall be city employees.

(Ord. 3285, adopted 11-28-1994; Ord. 3540, passed 6-9-2004; Ord. 3647, passed 4-25-2005; Ord. 3654, adopted 6-27-2005; Ord. 3773, passed 7-12-2010)

§ 1-16 AUTHORITY OF BUREAU.

(a) The Bureau may dispose only of municipal civil infraction violations for which a municipal civil infraction notice has been issued and for which a fine has been set by ordinance. Nothing in this ordinance shall prevent or restrict the City of Flint from issuing a municipal civil infraction citation for any violation or from prosecuting any violation in the 68th District Court.

(b) The limit of the Bureau's authority shall be to accepting admissions of responsibility for municipal civil infraction notices and the collecting of fines and costs resulting from these admissions. The Bureau shall not accept payment from a person who is denying responsibility for a municipal civil infraction or admitting responsibility with explanation.

(c) The notices shall include the time of the alleged violator shall appear before the Bureau, the methods by which an appearance can be made, the address and telephone number of the Bureau and the hours during which the Bureau is open.

(d) If an authorized local official issues and serves a municipal civil infraction notice and the alleged violator does not admit responsibility and pay the fines and costs, a municipal civil infraction citation shall be issued and filed with the 68th District Court, with a copy mailed to the alleged violator (defendant) as provided in ordinance no.

(e) The Bureau is authorized to accept payment of fines and costs in response to municipal civil infraction violation notices, and shall not be authorized to accept monies or admissions of responsibility in response to municipal civil infraction citations.

(f) The Bureau shall not accept payment of a fine or costs from any person who denies having committed a municipal civil infraction charged in a municipal civil infraction violation notice.

(g) The Bureau shall not have authority or jurisdiction to determine, or attempt to determine, the truth or falsity of any fact or matter relating to an alleged violation.

(Ord. 3541, passed 6-9-2004; Ord. 3648, passed 4-25-2005)

§ 1-17 ELECTION OF PERSON SERVED WITH VIOLATION NOTICE.

(a) Any person receiving a municipal civil infraction violation notice shall be permitted to dispose of the charge alleged in the notice by making payment of the fine and/or costs to the Bureau. However, a person shall have the right to elect not to have the violation notice processed by the Bureau and to have the alleged violation notice processed in the 68th District Court. The unwillingness of any person to dispose of a violation at the Bureau shall not prejudice the person or in any way diminish the person's rights, privileges and protection accorded by law.

(b) A person electing to have the alleged violation notice processed at the Bureau shall appear at the Bureau and pay the specified fine and/or costs within the time specified for appearance in the municipal civil infraction violation notice. Such appearance may be made by mail, in person or by representation, provided if appearance is made by mail, the person charged in the notice shall have the responsibility for timely delivery of the fine and/or costs within the time specified in the municipal civil infraction violation notice.

(c) In the event a person elects not to admit responsibility and pay the specified civil fine and/or costs prescribed for the respective violation notice, a municipal civil infraction citation may be issued. The authorized local official is not required to issue a municipal civil infraction citation notice as a precondition of issuance of a citation.

(Ord. 3542, passed 6-9-2004; Ord. 3649, passed 4-25-2005; Ord. 3655, adopted 6-27-2005)

§ 1-18 SCHEDULE OF FINES FOR A MUNICIPAL CIVIL INFRACTION VIOLATION NOTICE.

(a) A schedule of civil fines payable to the Bureau by persons served with municipal civil infraction violation notices is hereby established.

(b) The fines for the violations of the Code sections listed in § 1-20(a) shall be as follows:

<i>Offense</i>	<i>Fine</i>
First Offense:	\$25.00
Second Offense:	\$50.00
Third or Subsequent Offense:	\$150.00

(c) The fines for the violations of the Code sections listed in § 1-20(b) shall be as follows:

(1) Up to \$5,000.00 per occurrence, plus costs and other sanctions for each offense.

(Ord. 3543, passed 6-9-2004; Ord. 3774, passed 7-12-2010)

§ 1-19 PENALTIES FOR MUNICIPAL CIVIL INFRACTION CITATIONS.

(a) The following civil fines shall apply when there has been a determination of responsibility for a municipal civil infraction citation, unless a different fine is specified within a particular Code provision.

(1) *First offense.* The civil fine for a first offense violation shall be no less than one hundred fifty dollars (\$150.00), plus costs and other sanctions, for each offense.

(2) *Repeat offense.* The civil fine for any offense which is a repeat offense shall be no less than two hundred fifty dollars (\$250.00), plus costs and other sanctions for each offense.

(3) Certain violations as outlined in Chapter 46 may be punishable by up to five thousand dollars (\$5,000.00) per violation, per day, plus costs and other sanctions for each offense.

(b) In addition to ordering a defendant determined to be responsible for a municipal civil infraction citation to pay a civil fine, costs, damages and expenses, the judge or magistrate shall be authorized to issue any judgment, writ or order necessary to enforce this Code, enjoin a violation of this Code and/or abate a violation of this Code.

(1) A judge or magistrate shall issue an order to enforce this Code, enjoin a violation of this Code and/or abate a violation of this Code, and shall order the defendant to pay all costs associated with enforcement of this Code, enjoining a violation of this Code and/or abating a violation of this Code, for any defendant determined responsible for a municipal civil infraction.

(2) Upon a written ex parte motion with affidavit a judge or magistrate shall be authorized to issue an order to enforce this Code, to enjoin a violation of this Code and/or abate a violation of this Code prior to a determination of responsibility.

a. A defendant shall be required to pay all costs associated with the enforcement of this Code, enjoining a violation of this Code and/or abatement of a violation of this Code, only if the defendant is determined responsible.

(c) Each violation, and each day upon which any such violation shall continue to exist, shall constitute a separate offense and shall be considered a continuing violation.

(d) A judge or magistrate is authorized to order any remedies provided for in this Code along with any equitable or other remedies available by law.

(e) The judge or magistrate shall be authorized to impose fines, costs, damages and/or sanctions as provided by law.

(f) A municipal civil infraction citation shall not be a lesser included offense of a criminal offense or of an ordinance violation which is not a civil infraction.

(g) For violations of an owner or occupant of the subject property concerning the use, condition, occupation of land, building or other structure, fines, costs, damages and/or sanctions which are delinquent shall be a lien against the property, and assigned to the City of Flint's tax roll.

(1) Upon a finding of responsibility, a defendant shall be immediately responsible for all fines and costs, unless the court orders a longer time, but in no case shall a defendant have longer than 90 days from the time of the finding of responsibility to make full payment.

(2) If a defendant has not made full payment within 30 days after the date on which payment is due under section (g)(1), the payment shall be considered delinquent.

(3) In a municipal civil infraction action brought for a violation involving the use, occupation, condition of land, a building or other structure where the payment is delinquent, the City of Flint shall record the lien against the property which is the subject matter of the violation by recording a copy of the court order requiring payment of the fines, costs, damages and/or sanctions with the Genesee County Register of Deeds. Such order or judgment shall include a legal description of the property.

(4) The court order recorded with the Genesee County Register of Deeds shall constitute notice of the pendency of the lien. In addition, a written notice of the lien shall be sent by the City of Flint by first class mail to the owner of record of the land, building, or structure at the owner's last known address.

(5) The lien may be enforced and discharged by the City of Flint in the manner prescribed by its Charter, the General Property Tax Act, 1896 PA 206,, MCLA 211.1 to 211.157, or by ordinance. However the property is not subject to sale under the General Property Tax Act, 1896 PA 206, MCLA 211.1 to 211.157, for delinquent property taxes or under this ordinance.

(6) A lien created under this section has priority over any other lien unless one or more of the following apply:

a. The other lien is a lien for taxes or special assessments.

b. The other lien is created before May 1, 1994.

c. Federal law provides that the other lien has priority.

d. The other lien is recorded before the lien under this section.

(7) A political subdivision may institute an action in a court of competent jurisdiction for the collection of the judgment imposed by a court order for a municipal civil infraction. However, an attempt by the City of Flint to collect the judgment by process does not invalidate or waive the lien upon the land, building or structure.

(8) A lien provided for by this section shall not continue for a period of longer than five (5) years after a copy of the court order imposing a fine, costs or assessment is recorded, unless within that time an action to enforce the lien is commenced.

(9) If a defendant defaults in the payment of a civil fine, costs, assessment or if applicable, or any installment, as ordered pursuant to this section that does not deal with property and therefore is not subject to the lien procedure, that defendant shall be subject to civil contempt procedures as outlined in MCLA 600.8729.

(Ord. 3544, passed 6-9-2004; Ord. 3650, passed 4-25-2005; Ord. 3656, adopted 6-27-2005; Ord. 3729, passed 10-27-2008)

§ 1-20 DESIGNATION OF MUNICIPAL CIVIL INFRACTIONS.

Violation of the following sections of this Code or the violation of any regulation adopted through these Code provisions shall be deemed to be a municipal civil infraction which shall subject the violator to the civil fines and penalties as provided in this chapter:

(a) Sections 11-1, 11-2, 11-10, 11-24, 12-2, 12-11, 12-19, 12-25, 12-39, 12-43, 12-48, 12-49.2, 12-52, 12-53.1, 12-54.1, 12-54.2, 12-62.1, 12-63, 12-67.1, 12-67.2, 12-67.3.2, 12-67.3.4, 12-67.3.5, 12-67.3.6, 12-67.3.7, 12-67.3.8, 12-67.3.9, 12-67.3.10, 12-67.3.11, 12-67.3.12, 12-67.3.13, 12-82, 16-1, 17-2, 17-4, 17-5, 17-6, 22-1, 24-1, 30-3, 30-4, 30-7, 30-9, 30-11, 30-12, 30-13, 30-14, 30-15, 30-18, 30-20, 30-21, 30-

22, 30-23, 30-25, 30-26, 31-48.1, 36-1, 39-5, 39-6, 39-7, 39-9, 39-12, 39-13, 39-14, 39-18, 39-18.1, 39-19, 39-20, 39-20.1, 39-21 and 42-47(b).

(b) Sections 46-127, 46-128, 46-129, 46-131, 46-132, 46-139, 46-145, 46-146, 46-147, 46-149, 46-150, 46-151, 46-153, 46-154, 46-155, 46-170, 46-174 and 46-175.

(Ord. 3545, passed 6-9-2004; Ord. 3775, passed 7-12-2010)

§ 1-21 REPEAL.

(a) *Repeal.* All ordinance provisions inconsistent with the provisions contained in §§ 1-10 through 1-21 are hereby repealed.

(Ord. 3546, passed 6-9-2004)



Sheldon Neeley
Mayor

CITY OF FLINT

FLINT PLANNING COMMISSION

Draft Meeting Minutes
April 9th, 2024

Commissioners Present

Robert Wesley, Chair
Carol-Anne Blower, Vice-Chair
Lynn Sorenson, Secretary
Robert Jewell
Mona Munroe-Younis
Jeffrey Curtis Horton

Staff Present

Tom Sparrow, Assistant City Attorney
Montel Menifee, Marihuana Licensing Coordinator
Brian Acheff, Zoning Coordinator
Max Lester, Int. Zoning Coordinator
Dalton Castle, Planner I
Tyler Bailey, Deputy Director of Business Services

Absent:

Joshua Brown
Nadiya Rodriguez

ROLL CALL:

Chairperson Wesley called the meeting to order at 5:40 p.m. Roll was taken, and a quorum was present.

The meeting was held both in-person in the Dome Auditorium and via Zoom conferencing as approved.

Roll Call:

Commissioner Brown: absent
Commissioner Blower: present
Commissioner Jewell: present
Commissioner Rodriguez: absent

Commissioner Sorenson: present
Commissioner Munroe-Younis: present
Commissioner Horton: present
Chairperson Wesley: present

ADDITIONS/CHANGES TO THE AGENDA:

Chairperson Wesley asked if there were any additions or changes to the agenda. Commissioner Jewell noted that according to the City's bylaws the Planning Commission's election of officers is to be held at the April 23rd meeting.

Commissioner Jewell reiterated his concern from the February 27th, 2024 Planning Commission meeting that there is an "information overload" with the amount of material staff is providing to the Commissioners for review as well as the high volume of public hearings and site plan reviews on the agenda. He also commented on the high volume of case reviews for conditional approvals made by the Planning Commission that are still pending.

Commissioner Jewell recommended setting aside time at a future meeting to discuss the department name change from "Planning and Development" to "Business and Community Services."



Sheldon Neeley
Mayor

CITY OF FLINT FLINT PLANNING COMMISSION

located at 4221 James P. Cole Blvd, Flint, MI 48503 (PID #47-31-280-015) pending receipt of a Certificate of Occupancy. Commissioner Horton seconded the motion.

Roll Call:

Commissioner Brown: absent
Commissioner Horton: yes
Commissioner Blower: yes
Commissioner Jewell: yes

Commissioner Rodriguez: absent
Commissioner Sorenson: yes
Commissioner Munroe-Younis: yes
Chairman Wesley: yes

M/S – Blower/Horton
6 yes, 0 no, 0 abstain
The motion carried.

PC 24-08: The City of Flint is proposing Text Amendments to Article 18 Administration and Enforcement of the City of Flint Zoning Ordinance.

Max presented the staff report. The proposed changes would clearly designate the building official, and staff designated by them as having authority to enforce the Zoning Ordinance. The proposed changes would additionally allow staff to enforce violations by issuing municipal civil infractions.

Commissioner Munroe-Younis asked Max if they still believe the proposed enforcement options to be the most appropriate. Max explained that they do and currently the only options for enforcement are to seek a court order or an injunction which are not ideal for the City or respondents.

Commissioner Jewell asked what the disadvantages are of the proposed text. Tyler stated the disadvantages are that the City is currently incapable of effectively enforcing the Zoning Code.

Commissioner Sorenson asked if the enforcement officer would have the ability to make decisions on subjective situations. Max explained the enforcement officer would need to reference enforcement action to a specific provision in the Zoning Code. Additionally, the text would limit enforcement to only the Zoning Code by identified enforcement individuals.

Chairperson Wesley opened public comment on PC 24-08. No one spoke.

Commissioner Jewell asked staff if there had been any additional communications regarding PC 24-08. Max said there have not been any additional communications regarding PC 24-08.

Commissioner Munroe-Younis made a motion to send a resolution to the City Council recommending approval of the proposed Text Amendments to Article 18 Administration and Enforcement of the City of Flint Zoning Ordinance. Commissioner Blower seconded the motion.



Sheldon Neeley
Mayor

CITY OF FLINT

FLINT PLANNING COMMISSION

Roll Call:

Commissioner Brown: absent
Commissioner Horton: yes
Commissioner Blower: yes
Commissioner Jewell: yes

Commissioner Rodriguez: absent
Commissioner Sorenson: yes
Commissioner Munroe-Younis: yes
Chairman Wesley: yes

M/S – Munroe-Younis/Blower

6 yes, 0 no, 0 abstain

The motion carried.

SITE PLAN REVIEW:

SPR 24-05: The applicant Crooked Ladder Inc. requests approval of a Site Plan Review Application to redevelop the property located at 2730 S Dort Hwy (PID #41-20-278-019) into a “Group G”, Class A Marihuana Microbusiness.

Brian read the staff report. He noted that there are three variances that were approved by the Zoning Board of Appeals for this project. Staff recommends conditional approval of SPR 24-05 pending completion of Water and City Engineering Department reviews and allowance of planters along the building as a substitute to the required building foundation zone landscaping. Brian noted that the Fire Department had requested the addition of a fire hydrant to the site to which the applicant has complied, however the hydrant is currently not displayed on the plans.

Commissioner Jewell reiterated his desire for renderings of proposed developments to be provided, especially in the case of marihuana related development. He additionally raised concern on the requested conditions of approval and stated his belief is that without completion of all departmental reviews he would normally consider the application incomplete.

Commissioner Jewell asked staff if they requested a rendering be provided. Brian explained that the Ordinance does not require a rendering as part of the application and staff views requiring a rendering to be an undue financial burden on the applicant. Brian stressed there being a distinction between brand new developments that are by nature a spectacle versus a redevelopment of an existing site. Brian advised the Commission to request a text amendment to require renderings as part of applications if they deem it necessary. Commissioner Jewell stated that the Planning Commission has historically received renderings as part of applications and believes having them provided would benefit applicants.

John McNicol, the business owner, presented the application.

Chairperson Wesley asked what the building would look like. Mr. McNicol said the building will look very similar to how it looks now with renovations such as repainting and replacing the metal siding.